

ANNUAL
REPORT

2000



BANK INDONESIA

Front Cover :
Bank Indonesia Thamrin Tower

Head Office Address :
Jl. MH. Thamrin No. 2
Jakarta 10010
Indonesia
website : www.bi.go.id

This report presents a comprehensive review of the roles and achievements of Bank Indonesia in 2000, as well as its targets and monetary policy program for the year 2001. A preliminary version of this material was presented to the House of Representatives and the public through the media on January 10, 2001, pursuant to Article 58 of the Act Number 23 of 1999 on Bank Indonesia

**ANNUAL
REPORT**

2000



BANK INDONESIA

Vision Statement of Bank Indonesia

To establish Bank Indonesia as a trustworthy and respected central bank

Mission Statement of Bank Indonesia

To attain and maintain monetary stability in order to achieve Rupiah stability through the formulation and implementation of tasks in a more accountable and transparent manner with high integrity

Symbols, Reporting Period, and Source of Data

r	Revised figures
*	Provisional figures
**	Incomplete figures
. . .	Data are not yet available
-	Not available
x	Figures in before and after mark could not be compared
--	Nil or less than the last digit
\$ (dolar)	United States Dollar

Reporting period is January 1, 2000 to December 31, 2000

Source of data is Bank Indonesia unless mentioned otherwise

**Board of Governors
of Bank Indonesia**
as of December 31, 2000



Syahril Sabirin
Governor



Anwar Nasution
Senior Deputy Governor

Miranda S. Goeltom
Deputy Governor



Aulia Pohan
Deputy Governor



Achwan
Deputy Governor



Achjar Iljas
Deputy Governor



Burhanuddin Abdullah
Deputy Governor





**GOVERNOR
BANK INDONESIA**

PREFACE

In praise of God the Almighty, we present Bank Indonesia's Annual Report for the year 2000. As in previous years, Bank Indonesia's Annual Report is a manifestation of Bank Indonesia's accountability in discharging its tasks. The report depicts major developments influencing the economy during the reporting year. Also included as important parts of this annual report are the prospects and outlook for future policies.

Unlike the previous annual reports, the year 2000 Annual Report marked a cornerstone, reflecting the first full year during which Bank Indonesia carried out its tasks under Act Number 23 of 1999 on Bank Indonesia. Act Number 23 provides a strong legal basis for Bank Indonesia in performing its duties, which focus on maintaining the stability of rupiah, supported by a balance between independence and accountability of Bank Indonesia.

In fulfilling its duties, at the beginning of the year Bank Indonesia announced an inflation target for the year 2000 of between 3.0% and 5.0%, excluding the impact of the government's price and incomes policy. This inflation target took into account the characteristics of Indonesian inflation, which is strongly influenced by non-monetary factors such as administered prices set by the government and increases in civil servant salaries in addition to supply developments. To take these factors into account, at the beginning of the year Bank Indonesia also announced a forecast of the expected impact of government policies during the year.

From the operational point of view, to achieve the inflation target Bank Indonesia announced a target growth rate for base money, which is to provide guidance during the reporting year. The base money growth target was estimated on the basis of certain assumptions regarding factors that influence inflation, such as economic growth, the exchange rate, and government financial developments. Another equally important assumption was political stability, as this is essential to restore confidence in the national economic recovery. At the beginning of the year these assumptions were considered fairly realistic, as inflation was still very low in 1999 and there was plenty of room for the economy to grow, with consumer spending providing the main impetus. The improved social and political situation following the establishment of a new government had also encouraged a spirit of optimism. At the same time, robust world economic growth provided a strong foundation for improved export performance.

However, developments during the year made necessary significant revisions to these assumptions. While there were some encouraging developments, such as higher economic growth than originally expected, there were also less favorable developments, including growing inflationary pressure, a weakening exchange rate and heightened social and political uncertainty.

In view of these developments, Bank Indonesia sought to respond by optimizing favorable developments while minimizing the risks. We should be grateful that we achieved fairly healthy economic growth, supported by robust exports and investment. In the case of Indonesia, which is striving to recover from economic crisis, this relatively high economic growth had helped accelerate economic recovery. This momentum should be maintained in the years ahead since a set back would be very costly. Of course, we also hope that the high economic growth can be achieved at a minimum cost, meaning a low level of inflation, which is a prerequisite for sustained growth.

Against this background, Bank Indonesia pursued a tight bias monetary policy stance in 2000. To this end, Bank Indonesia absorbed excess liquidity so as to ease the pressure on inflation and the rupiah exchange rate, while simultaneously avoiding a drastic and excessive increase in interest rates. A drastic and excessive increase in interest rates might threaten the corporate debt and bank restructuring process currently in progress and challenge fiscal sustainability, which might undermine our hard won economic recovery.

In pursuit of this policy, we have to admit that we are confronted with a dilemma. Inflation rate and the rupiah exchange rate, which is a basic assumption in setting the inflation target, came under pressure from mid-2000, which necessitated an effort to prevent it from becoming persistent, as this could lead to high inflationary expectations. In fact, this was not an easy endeavor. We are fully aware that excessive tightening would run counter to the economic recovery. Moreover, the monetary transmission mechanism had become less effective due to the fact that the banking system which was still undergoing a consolidation process. This environment called for extra caution in the conduct of monetary policy.

In the effort to keep the growth of base money in check, the problems faced by Bank Indonesia had become more complex due to changes in the public's attitude to holding currency. Currency is an important component of base money, which has been under close monitoring by Bank Indonesia since this is an indicative target. During the year 2000, the amount of currency in circulation grew significantly, which caused difficulties in keeping in the growth of base money within the target. We identified several reasons behind the strong growth of currency in circulation, namely high transactions demand as a result of rapid economic growth, a high inflation rate and inflationary expectations, low real interest rates, which made bank deposits less attractive, and the coincidence of several public holidays in December last year.

The ineffectiveness of the monetary transmission mechanism as bank intermediation had not fully recovered was just one of the problems associated with the bank restructuring program. In our observation, restoring the soundness of the banking system was key to the revival of the overall economy.

During the reporting period, several measures were taken to continue and strengthen the efforts to improve bank soundness in close cooperation with other agencies such as the Indonesian Bank Restructuring Agency (IBRA). We noted the progress in credit restructuring which was expected to serve as a stimulus for business recovery, as well as to accelerate bank restructuring itself. The completion of the domestic bank recapitalization program was a crucial accomplishment during the reporting period. Bank Indonesia also improved banking regulations so as to strengthen the soundness of practices in banking. These measures were supplemented by efforts to improve bank supervision and management quality. All these measures were designed to strengthen bank resilience at every level, as a sound banking system provides a crucial foundation for a sustainable economy.

While Bank Indonesia was launching various endeavors to carry out these tasks, there remained some disturbing problems associated with Bank Indonesia's efforts to perform its duties in the past, particularly efforts by Bank Indonesia and the government to respond to the crisis. Settlement of the BLBI problem was protracted and this disturbed the concentration of Bank Indonesia's management. It is hoped that the settlement of the BLBI problem, as agreed by the government and Bank Indonesia, will finally resolve this issue, hence removing this burden in the future.

Another serious problem that we are currently confronted with is the implementation of Act Number 23 of 1999 on Bank Indonesia, which has appeared to be not as smooth as expected, particularly with regard to the issue of central bank independence. The problem intensified toward the end of the year following a proposal to amend the Bank Indonesia Act, even though it had been in place for less than two years. The emergence of this issue also absorbed a good deal of Bank Indonesia's attention and resources during 2000.

Looking ahead to 2001, it must be admitted that the problems we will encounter will be complex and intertwined. But the lessons we have learned in discharging our tasks in 2000 will serve as precious experience for Bank Indonesia to perform better in the future not only as an independent but also as an accountable central bank. Bank Indonesia will endeavor to achieve an inflation target for 2001 of between 4.0% and 6.0% - not including the inflationary impact of the government's price and incomes policy - as announced following the January 9, 2001 Board of Governors meeting. It is very important to achieve this inflation target so as to contain inflationary expectations.

Bank Indonesia is firmly committed to assuming these tasks for the sake of the nation. My view is that Bank Indonesia's accountability must be judged in relation to the framework Bank Indonesia will adopt. This includes the accountability of the entire framework, starting from planning and implementation through the final evaluation process. The process starts with setting an inflation target, followed by a close monitoring of monetary aggregates, in this case base money, which affects economic developments. Bank Indonesia has also held monthly and quarterly meetings of its Board of Governors, the results of which have been announced publicly. We periodically submit quarterly reports to the Indonesian House of Representatives.

We sincerely hope that all the efforts that Bank Indonesia has taken, including all measures taken to address problems and obstacles, will be perceived as part of Bank Indonesia's accountability. We do not deny any shortcom-

ings of Bank Indonesia in the performance of its duties. Some of the shortcomings are internal by nature and have been evaluated, and Bank Indonesia is determined to improve. But we should also be aware that some of the shortcomings originated from external factors. For this reason we welcome the support of various parties so as to enable Bank Indonesia to discharge its duties more effectively. With regard to the progress that we have achieved, we will not be self-complacent; rather, we will step up our efforts for further improvements. To achieve these goals we welcome all constructive suggestions and criticisms.

Finally, on behalf of Bank Indonesia's Board of Governors, I wish to express my thanks to all of Bank Indonesia's management and staff, who in 2000, despite all of the turbulence and numerous problems, showed great patience and perseverance in performing their professional duties as mandated by Act Number 23 of 1999 on Bank Indonesia. To the readers of this annual report, I trust that Bank Indonesia's Annual Report will serve as a useful reference. May God the Merciful bless us all and guide our every move in the future.

Jakarta, February 2001

Governor of Bank Indonesia

A handwritten signature in black ink, consisting of a stylized initial 'S' followed by a long horizontal line that ends in a small flourish.

Syahril Sabirin

Chapter 1

Overview



The outlook for the Indonesian economy at the beginning of the year 2000 was relatively bright. Signs of economic recovery had already begun to appear from the third quarter of 1999. Monetary stability had been attained, as reflected in a low inflation rate and a stronger exchange rate toward the end of 1999. The social, political and security situation had improved with the election of national leaders through a process widely viewed as successful and democratic. These positive developments made possible a further decline in interest rates toward the end of 1999 and provided a boost to the stock market, thereby giving renewed momentum to the process of economic recovery.

With these positive developments, and in light of fundamental economic conditions that were marked by a large amount of excess productive capacity and a conducive world economic situation, Bank Indonesia predicted that economic growth would reach 3.0%–4.0% in the year 2000. Accordingly, Bank Indonesia set a target for the inflation rate, excluding the impact of the government's price and incomes policy, of 3.0%–5.0%. The government's price and incomes policy was expected to add an additional 2.0% to the inflation rate over and above the target. To reach this inflation target the growth rate of base money was set at 8.3% from the position targeted for the end of 1999.

During the course of the year 2000 a number of indicators pointed to a more rapid economic recovery. Economic growth reached 4.8%, exceeding the initial projection. Several factors, such as stronger domestic demand, an exchange rate that remained competitive, and favorable world economic conditions, contributed to better performance in several sectors of the economy, including in the small and medium enterprise sector where activity expanded both for domestic consumption and for exports. Progress was also achieved in bank-restructuring, government foreign debt restructuring, and in resolving the Bank Indonesia Liquidity Sup-

port (BLBI) problem between Bank Indonesia and the government.

Nonetheless, several fundamental problems and a high degree of uncertainty continued to hold back the economic recovery process, preventing a more rapid and sustained recovery. Compared to other Asian crisis economies, Indonesia's economic recovery was relatively slow. At the micro level, the continued existence of many constraints limiting a more rapid recovery of private investment gave rise to concerns regarding the medium-term sustainability of the recovery process. The growth of credit from the banking system was still limited even though the overall condition of the banks had improved. Progress in the restructuring of corporate debt and foreign private debt was also not as rapid as had been hoped. The size of the government's fiscal burden, due mainly to interest on government debt and to subsidies, limited the fiscal stimulus for economic recovery and gave rise to concerns about fiscal sustainability in the medium and long term. The high level of optimism at the beginning of the year regarding the domestic political, security and legal situation was apparently not supported by subsequent developments.

With these fundamental problems plus the uncertainty factor, the process of economic recovery during the year 2000 was marked by increased pressure on the exchange rate and rising inflation. From May 2000 on, the rupiah exchange rate tended to weaken and to become more volatile as the domestic political and security situation grew increasingly tense, and also in response to pressure caused by the gap between demand and supply in the foreign exchange market. At the same time, the continuation of various structural problems prevented aggregate supply from rising as quickly as aggregate demand, which contributed to increased inflationary pressure. Inflation also increased as a consequence of the government's price and incomes policy and in response to the depreciation of the rupiah.

These developments caused inflation to exceed the target set at the beginning of the year.

The economic and inflationary conditions described above made the formulation and implementation of monetary policy increasingly difficult in the year 2000. Bank Indonesia's monetary policy faced a dilemma. On the one hand, a tightening of monetary policy was needed in response to increased pressure on domestic prices and on the exchange rate. On the other hand, it was not possible to drastically or excessively tighten monetary policy because this might have threatened the recovery of the banking system and the corporate restructuring process, both of which remained fragile. Failure in these areas, in turn, could undermine public confidence in the overall prospects for economic recovery. The result could be a return to the inflation-depreciation spiral experienced at the peak of the economic crisis.

Faced with the problems of inflation and the exchange rate, and given the economic conditions described above, Bank Indonesia chose to adopt a tight bias monetary policy, particularly from May 2000. This meant that monetary policy would still aim to absorb excess liquidity in the economy so as not to increase pressure on inflation and the rupiah exchange rate, while at the same time avoiding a drastic and excessive increase in interest rates. The monetary target established at the beginning of the year had to be adjusted to accord with more rapid economic development than had been assumed originally. These efforts in the monetary sector were accompanied by banking policies that remained focused on programs to improve the soundness and resilience of the banking industry for the future. In the payment system, various improvements continued to be implemented to create an efficient, rapid, safe and reliable national payment system to support the effective implementation of monetary policy and to support efforts to create a healthy banking system.

Looking forward, Bank Indonesia believes that the economic recovery process will continue in 2001. Economic growth is expected to reach 4.5%–5.5%, with the source of growth coming from a continuation of relatively good export performance and rising investment. This optimistic assessment is based on

the assumption that the economic reform and restructuring process will accelerate in several areas, particularly the restructuring of corporate debt and more rapid restoration of the bank intermediation function. In addition, the process of allocating and utilizing natural resources more efficiently is expected to continue and to be supported by a competitive exchange rate and by growth of the world economy, which is expected to remain conducive in 2001. Overall, if the domestic social, political and security situation improves, Bank Indonesia foresees that the domestic economic momentum will gain strength.

With due consideration to macroeconomic developments and prospects, and taking into account price developments that can be influenced by monetary policy, Bank Indonesia set the inflation target for 2001, excluding the impact of the government's price and incomes policy, at 4.0%–6.0%. The impact of the government's price and incomes policy is expected to add 2.0%–2.5% to the inflation rate, over and above the target.

To achieve this inflation target, Bank Indonesia will control the growth of base money so that it is consistent with the needs of the economy. Bank Indonesia therefore sets the target for the growth rate of base money in 2001 at 11.0%–12.0%. This growth target is calculated from the level of base money in December 2000 after correcting for the strong seasonal factor in that month.

To achieve these targets, Bank Indonesia considers that it will be necessary for the time being to maintain the tight bias monetary policy stance while optimizing various monetary instruments. Bank Indonesia will continue to observe price and exchange rate developments and will strive to achieve the established target for inflation so as to support a sustainable economic recovery. In the banking sector, Bank Indonesia's policy will be oriented to efforts to foster the accomplishments of the bank restructuring program and to restore the intermediation function of banks, while continuing to apply prudential principles in managing the national banking system. To support the effective implementation of monetary policy and to accelerate the recovery of the banking industry, payment system policy will be directed toward accelerating the development and

implementation of a national payment system that is efficient, accurate, safe, and reliable through improvements of service quality.

Evaluation of the Indonesian Economy in the Year 2000 Macroeconomic Condition

Overall, during the year 2000 Indonesia experienced a stronger and more balanced economic recovery. Gross domestic product (GDP) grew by 4.8%, which was higher than Bank Indonesia's estimate at the beginning of the year of 3.0%–4.0%. The bank recapitalization program was completed, progress was achieved in resolving the government's foreign debt, and an agreement was reached between Bank Indonesia and the government on resolving the BLBI (Bank Indonesia Liquidity Support) problem. Nonetheless, the continuation of several fundamental economic problems limited the speed of the economic recovery. These problems mainly concerned the slow pace of corporate debt restructuring, the absence of significant recovery of the bank intermediation function, and the lack of a significant fiscal stimulus that could promote economic recovery.

Growth in 1999 came mainly from consumption. In 2000 the source of economic growth was more broad based. With the support of a competitive exchange rate, non-oil exports became an engine of growth. Investment also began to rise as some bank financing started to become available and as self-financing from retained earnings continued on a large scale. Capacity utilization rates actually reached high levels in several sectors as production expanded to meet domestic and export demand. Consumption expenditure continued to rise along with improved incomes for some sectors of society, both from wages and salaries and from exports. The contribution of exports, investment and consumption to economic growth in 2000 reached 3.9%, 3.6% and 3.1%, respectively. The strong performance of exports and higher contribution of investment to GDP indicated that the economic recovery process was becoming increasingly stable.

From the supply side, all sectors of the economy recorded positive growth. Stimulated by both domestic and foreign demand, manufacturing, trade and transport became the

engines of growth, and these three sectors contributed 1.6%, 0.9% and 0.7% to GDP growth, respectively. The growth rate of manufacturing reached 6.2% in 2000, while trade grew by 5.7% and transport grew by 9.4% (Table 1.1).

In the external sector, the balance of payments remained favorable in 2000. The current account surplus rose by \$1.9

Table 1.1
Selected Macroeconomic Indicators

Item	1998	1999	2000
	Annual growth (In percent)		
Real Gross Domestic Product (at constant 1993 prices)	-13.1	0.8*	4.8**
By Expenditure			
Consumption	-7.1	4.3	3.9
Gross domestic fixed capital formation	-33.0	-19.4	17.9
Exports of goods and services	11.2	-31.6	16.1
Imports of goods and services	-5.3	-40.7	18.2
By Sector			
Agriculture	-1.3	2.7	1.7
Mining and quarrying	-2.8	-2.4	2.3
Manufacturing	-11.4	3.8	6.2
Electricity, gas, and clean water	3.0	8.3	8.8
Construction	-36.4	-0.8	6.7
Trade, hotel, and restaurant	-18.2	0.1	5.7
Transportation and communication	-15.1	-0.8	9.4
Financing, rental, and corporate services	-26.6	-7.5	4.7
Other services	-3.8	1.9	2.2
Monetary			
Base money	63.0	35.5	23.4
M2	62.3	11.9	15.6
M1	29.2	23.2	30.1
Quasi money	71.7	9.5	12.1
Interest Rate (%)			
SBI 1 month	38.4	12.5	14.5
Interbank overnight	33.4	12.1	11.4
Time Deposit 1 month	41.4	12.2	12.0
Working capital credit	34.7	20.7	17.7
Investment credit	26.2	17.8	16.9
Consumer Price Index	77.6	2.01	9.35
Balance of Payments			
Current account to GDP (%)	4.2	4.1	5.0
Debt service ratio (DSR) (%)	57.9	56.8	44.8
International reserves (in months of non-oil/gas import & government debt services)	5.7	6.7	6.3
Average Exchange Rate (Rp/\$)	10,088	7,850	8,400

Sources :

- BPS-Statistics Indonesia
- Bank Indonesia

billion to \$7.7 billion in 2000, equivalent to 5.0% of GDP. This current account surplus was due not only to an improved oil and gas trade balance, but also to improved non-oil export performance, particularly from the manufacturing sector where the biggest contribution came from electronics, and from the mining sector where copper and nickel were the major contributors.

Unlike the current account, the capital account recorded a deficit of \$4.6 billion in 2000. This was due to the fact that foreign private capital flows had not recovered, mainly because international confidence in Indonesia's economic prospects had not been fully restored. Indonesia's overall balance of payments recorded a surplus of \$5.0 billion in 2000. By the end of December 2000 gross foreign exchange reserves had risen to \$29.33 billion, equivalent in value to 6.3 months of imports plus interest and principal on government debt.

To reduce the government's foreign debt burden, the Paris Club II meeting was held on April 12 and 13, 2000. In this meeting, it was agreed to reschedule principal payments on government debt falling due between April 1, 2000 and March 31, 2002, amounting to \$5.8 billion. In addition, as an extension of the London Club negotiations, it was agreed in September 2000 to reschedule \$340.0 million in principal payments on commercial debt received from a syndication of foreign banks.

Measures to restructure foreign private debt were undertaken at the same time. Private bank debt of \$6.3 billion was restructured through the exchange offer (EO). Private non-bank debt restructured through the Jakarta Initiative Task Force (JITF) reached \$9.4 billion by the year 2000, consisting of both domestic and foreign debt.

In the fiscal sector, it is estimated that the ratio of the provisional budget realization reached a deficit of 3.2% to GDP during the year 2000, lower than the budget deficit of 4.8% to GDP. The ratio of realized revenue to budgeted revenue reached 127.0%, whereas the ratio of realized expenditure to budgeted expenditure reached 113.6%. The 2000 fiscal deficit was financed by the sale of asset from the bank-restructuring program and by foreign borrowing. The relatively large size of total government revenue reduced the government's need

to draw on foreign borrowing to cover the budget shortfall. The amount of net foreign borrowing actually used for the budget reached only 62.0% of the initial plan. This allowed the government to improve the medium-to-long term sustainability of its fiscal structure, although at the same time it meant that the short-term fiscal stimulus to promote economic recovery was limited.

The main factor causing government revenue to exceed the target was the high price of Indonesia's crude oil in the international market in 2000, with the average price of Indonesian crude oil reaching \$29.1 per barrel, well above the budget assumption of \$20.0 per barrel. This increase in oil and gas prices also increased tax revenue, particularly oil and gas income tax remittances to the government. The realized tax ratio reached 11.8% of nominal GDP in 2000 compared to a targeted ratio of 11.1% in the budget for 2000. Excluding oil and gas income tax revenue, the realized ratio of tax revenue to GDP came to 10.0%, which was almost the same as the target.

On the expenditure side, almost 75.0% of realized spending was allocated for non-discretionary purposes, such as personnel expenditure, debt interest payments and subsidies. Personnel expenditures rose from the previous year due to the government's policy to raise the salaries of civil servants, military and the police force by providing additional allowance of Rp64,750 per employee in April and Rp65,000 per employee in October 2000. Increased spending on subsidies, particularly fuel (BBM) subsidies, was a consequence of the rise in oil prices, the depreciation of the rupiah, increased fuel imports, and the delay in implementation of subsidy reductions. Increased debt payments were due both to interest payments on foreign debt and to interest payments on domestic debt arising from the bank recapitalization program.

Exchange Rate and Inflation

As mentioned previously, with the continuation of several economic structural problems and rising with increased domestic uncertainty, the economic recovery process during the year 2000 was accompanied by increased pressure on the domestic price level and the exchange rate. The average exchange

rate during the year 2000 came to Rp8,400 per US dollar, which was higher than the exchange rate used in setting the inflation target of Rp7,000 per US dollar. Pressure on the exchange rate increased particularly after April 2000 as a consequence of political and security developments in the approach to the Annual Session of the People's Consultative Assembly held in August 2000, and also in response to the strengthening of the US dollar relative to almost all other major world currencies. The large demand for foreign exchange to meet offshore debt payments also affected the value of the rupiah. These pressures caused the rupiah to become undervalued and resulted in an exchange rate that was not in accordance with Indonesia's economic fundamentals.

In general, the tendency for the exchange rate to weaken was caused by a decline in public confidence in Indonesia's economic recovery prospects as a result of various internal and external factors. Internal factors contributing to depreciation arose from the still limited supply of foreign exchange in the market as a consequence of a continued low level of private capital inflows and the fact that export revenue was not fully repatriated, while the private sector continued to demand for foreign exchange, particularly to repay foreign debt. In addition, negative market sentiment regarding domestic political and security disturbances also increased pressure on the exchange rate.

Externally, rising world interest rates, the global strengthening of the US dollar, and regional exchange rate volatility, put pressure on the rupiah. The high volatility of the rupiah was also due to increased off-shore trading of the rupiah by non-resident market players, with the rupiah becoming increasingly internationalized. With an extremely limited supply of foreign exchange, the foreign exchange market was very thin, so that a small increase in demand caused a sharp changes in the exchange rate. Moreover, the market tended to be asymmetric, reacting excessively to negative news.

The acceleration of economic recovery beyond initial estimates also increased inflationary pressure, particularly the middle of the year. Inflationary pressure arose because growing aggregate demand could not be fully balanced by an

increase in aggregate supply due to the continued existence of structural problems in the economy. Inflationary pressure was also created by government policy to reduce subsidies and to allow prices to be determined by the market mechanisms, by the weakness of the exchange rate, and by strong inflationary expectations. These developments made it difficult to quickly reduce inflationary pressure because the steady upward tendency of the price level had a persistent character.

Strong inflationary pressure in the midst of an economic recovery process that was just getting underway created a dilemma for Bank Indonesia's monetary policy. On the one hand, efforts to safeguard price stability required monetary tightening measures so that inflationary expectations could be checked from the start, to the extent possible. On the other hand, hasty and excessive monetary tightening measures could blunt the enthusiasm of the business community and the public in general to engage in productive activity.

Implementation of monetary policy became even more difficult because Bank Indonesia faced limitations in controlling aggregate demand arising from the fact that the transmission mechanism from monetary policy to the real sector had not yet returned to normal. The banking system had excess liquidity because the bank intermediation function had not yet recovered, and consequently banks did not respond to Bank Indonesia's tight bias monetary policy stance with a corresponding increase in their interest rates. Controlling aggregate demand as initially planned would therefore have required a very large increase in interest rates, and it was feared that such measures would threatened the overall economic recovery process.

With these considerations, Bank Indonesia continuously monitored the development of the domestic price level during the year 2000 while attempting to achieve the established inflation target to support a sustainable economic recovery.

The inflation rate in the year 2000 actually reached 9.35%, measured year-on-year from December to December. This was higher than the 1999 inflation rate of 2.01%. The government's price and incomes policy is estimated to have contributed

3.42% to the inflation rate in 2000. This is higher than the original projection of 2.0% because a number of policies had not yet been identified at the beginning of the year. Tariffs were also increased by more than had been expected and there was a change in the pattern of implementation of government's policy. Excluding the impact of the government's price and incomes policy, the inflation rate in the year 2000 is estimated to have been 5.93%. This inflation rate still exceeded Bank Indonesia's inflation target of 3.0% to 5.0% for the year.

Monetary Policy and Development

Rising inflationary pressure and weakness of the exchange rate led Bank Indonesia to adopt a tight bias monetary stance beginning around May 2000. This policy was adopted to achieve a sufficiently low inflation rate, which is important for continuation of economic recovery in the long term, while at the same time giving due consideration to minimizing the impact on the bank recovery process, debt resolution, and the ongoing economic recovery.

The indicative target for base money in the year 2000 was established based on assumptions about the inflation target, economic growth, and the exchange rate. In connection with these assumptions, Bank Indonesia set the base money growth target at 8.3% for 2000. This target was implicitly optimistic regarding the recovery of economic activity but was also cautious concerning possible inflationary pressure that could arise.

However, Bank Indonesia's efforts to safeguard base money in 2000 experienced several constraints mainly due to the fact that the basic assumptions used to calculate the base money target did not match actual developments. GDP grew more rapidly than had been expected while the depreciation of the exchange rate was greater than predicted at the beginning of the year. Base money tended to continuously grow above the indicative target set at the beginning of the year, particularly from May 2000. A very large increase in base money occurred in December 2000 when it rose by Rp25.4 trillion from the November level of Rp100.2 trillion. Consequently, base money at the end of December stood at Rp125.6 trillion, an

increase of 23.4% from the position at the end of the previous year.

Viewed in terms of its components, the rapid growth of base money was caused by strong public demand for currency, due to both the high level of economic activity in 2000 and the decline of real interest rates on bank deposits. This problem was related to the bank intermediation function that had not returned to normal, causing an undesired banking response to monetary policy signals were not as expected. The strong demand for cash was also due to precautionary behavior by the public in light of the continued high level of uncertainty in 2000, as well as to the influence of seasonal factors those were particularly pronounced in December 2000 owing to the simultaneous occurrence of a number of religious festivities, the end of the fiscal year, and prolonged holidays. These factors caused the quantity of currency held by public to reach Rp72.4 trillion at the end of December 2000, an increase of 24.0% from a year earlier. The reserves held by commercial banks at Bank Indonesia, however, did not change significantly in 2000. Viewed in terms of the factors influencing base money, growth in 2000 was due to the expansion of net claims on the central government (NCG) and to open market operations (OPT).

In controlling base money, Bank Indonesia faced a dilemma, particularly in its effort to bring base money to the indicative target. This dilemma arose the issue of whether monetary policy should continue to follow the direction established at the beginning of the year, or should be realigned to support the economic recovery just getting underway, at the expense of achieving the inflation target. Faced with this situation, Bank Indonesia chose to adopt a monetary policy aimed at absorbing excess liquidity in order not to create additional pressure on inflation and the exchange rate. However, this measure was carried out cautiously to avoid a drastic and excessive increase in interest rates.

In carrying out monetary policy Bank Indonesia mainly made use of open market operations (OPT) in the form of sales of Bank Indonesia Certificates (SBI) and rupiah interventions in the money market. The strategy of controlling the money supply through open market operations was accom-

panied by measures to dampen excessive exchange rate fluctuation. Policy measures included sterilization operations in the foreign exchange market to absorb monetary expansion caused by government rupiah expenditure financed by funds originating from offshore. In addition, Bank Indonesia also conducted direct monitoring at a number of banks to increase compliance with prudential regulations that relate to foreign exchange transactions, in addition to monitoring vostro accounts as an initial step toward limiting rupiah transactions by non-residents.

Bank Indonesia's tight bias monetary policy was reflected in an increase in SBI rates in stages to provide a signal to the market underscoring the need to reduce pressure on inflation and the exchange rate. After dropping from 11.48% at the end of January to 10.88% in May, the one month SBI rate then began to rise gradually to reach 14.53% by the end of December. However, this increase in the SBI rate was not followed by a corresponding increase in bank deposit rates, as the banking system had excess liquidity due to the fact that the bank intermediation function had not yet returned to normal.

With this development, the real interest rate on bank deposits in 2000 declined gradually, reaching 2.56% by the end of the year. This decline in real interest rates reduced the opportunity cost of holding currency and encouraged portfolio adjustment by the public toward more liquid asset. During 2000, the growth of deposits and saving accounts in banks declined, while the growth of demand deposits and currency increased. This contributed to a more rapid growth of base money and M1, particularly toward the end of the period, while the growth of M2 declined.

Banking Policy and Development

In 2000, as an extension of policy in the previous year, policy for the banking sector remained focused on efforts to accelerate the bank soundness program and to increase the future resilience of the banking industry. The bank soundness program includes the government guarantee for commercial and rural development banks, bank recapitalization, credit restructuring, and faster recovery of the bank intermediation function.

Meanwhile, efforts to increase the resilience of the banking system focused on developing bank infrastructure, good governance, and improvements in the bank regulatory and supervisory framework.

In connection with the bank recapitalization program, the government and Bank Indonesia completed the bank recapitalization program on October 31, 2000, with the recapitalization of six banks (BNI, BRI, BTN, Bank Niaga, Bank Bali and Bank Danamon). During the year 2000, Rp148.6 trillion in government bonds were issued, bringing the total value of government bonds issued for the bank recapitalization program to Rp430.4 trillion.

With the completion of bank recapitalization, it is hoped that bank capital will no longer constrain bank soundness and the recapitalization bonds can be used as source of funds for the banks, either through their sale in the secondary market or as collateral. To increase the trading volume of government bonds in the secondary market, the government undertook measures to increase their attractiveness, including a bond exchange offer program. This program offered to exchange certain bonds held by banks series (FR 001 and 003) for stapled bonds series (FR 006, 007, 008 and 009) in order to increase trading in government bonds by enhancing their attractiveness to investors, and thereby assisting banks in fulfilling liquidity needs.¹⁾

Improvement of bank regulations is intended to increase the observance of sound prudential practices at banks in accordance with international standards. Improvements include fit and proper tests, exit policy, the legal lending limit, credit restructuring, asset valuation, institutional issues, short-term financing, allowing banks to trade government bonds, and the development of Islamic banks. The exit policy regulation constitutes a more transparent policy for handling unsound banks,

1) Stapled bonds are a package consisting of two types of bonds. The first type (FR 006 and 008) carry a coupon of 16.5% in accordance with yields demanded in the market, while the second type (FR 007 and 009) carry a coupon of 10.0%. The weighted average coupon of these two types of bond is 12.5%, which is the same as the coupon on the bank recapitalization bonds that can be provided in exchange for these stapled bonds.

by establishing criteria for banks to be categorized as “under special supervision” along with corrective measures that must be completed in a limited period, as well as criteria for banks to be transferred to IBRA (Indonesian Bank Restructuring Agency) as “banks under restructuring.”

In consolidating bank supervision, Bank Indonesia has improved the supervision system, which was previously focused on compliance based supervision, by broadening it to risk based supervision in line with international standards. Bank Indonesia has already placed supervisory personnel in several banks to establish an On-Site Supervisory Presence. To increase the capacity of bank supervisory personnel and to facilitate special surveillance, training and preparation for consolidated supervision had already been undertaken.

Efforts to improve good governance in bank management are intended to raise the competence and integrity of bankers through implementation of fit and proper tests, interviews with prospective owners and new entrants, and appointment of compliance directors responsible for ensuring that banks adhere to existing prudential regulations.

The application of these basic policies already produced results in the year 2000, with enhanced performance evident in several areas of national banking. With completion of the bank recapitalization program at the end of October 1999, bank capital increased to a positive value of Rp53.5 trillion by December 2000, from a negative value in 1999, thereby increasing the capital adequacy ratio of banks. At the same time the accumulation of bank funds began to be accompanied by an increase in lending activity. By December 2000 non-performing loans in the banking system had dropped to 18.8% on a gross basis or 5.8% on a net basis,²⁾ due to the transfer of bad loans to IBRA, credit restructuring and new lending. The net interest margin, which had been negative in 1999, increased to Rp22.8 trillion due to the emergence of positive spreads supported by relatively stable interest rates. It is expected that the trend toward improved

CARs, increased mobilization of funds and disbursement of loans, reduced non-performing loans, and positive net interest margins, will all continue in 2001.

Although significant progress was achieved, banks still face several challenges such as bank intermediation function to return to normal. This is due to the continued high level of risk as well as uncertainty and the ongoing process of credit restructuring. With limited lending activity, bank’s excess liquidity is mostly placed in SBIs, inter-bank loans and other securities. Such development must be closely monitored as it cannot guarantee the sustainability of bank performance in the future.

In connection with bank-restructuring, various efforts have already been undertaken by Bank Indonesia’s Bank-Restructuring Team and by IBRA. Improvement measures undertaken by Bank Indonesia’s Bank-Restructuring Team include efforts to increase coordination with IBRA and the Jakarta Initiative, coordination within Bank Indonesia, and the team professional capability mediating credit restructuring. Improvements in the strategy to accelerate credit restructuring have also been undertaken by IBRA, mainly by grouping credits based on business prospects and repayment potential, the attitude of the debtors, and by applying sanctions to non-cooperative debtors while giving incentives for cooperative debtors. In addition, to accelerate restructuring of small loans valued at less than Rp5 billion each, IBRA provided incentives in the form of an interest rate discount (25.0% to 50.0%), a waiver of fines (100.0%) and sale of credit.

By December 2000, the total amount of credits restructured both by banks themselves and through Bank Indonesia’s Credit Restructuring Team had reached Rp59.9 trillion or about 71.0% of total non-performing loans. Meanwhile, restructuring by IBRA that had reached the proposal implementation stage and the signing of a memorandum of understanding had reached 28.3% of the total amount of credits of Rp286.3 trillion. The speed of progress in credit restructuring, particularly IBRA’s credit restructuring, will be a factor promoting the recovery of the banking system and the level of investment activity in the coming period.

2) In international practice, NPLs are calculated on a net basis by calculating existing loan loss reserves.

Meanwhile, with the transfer of Bank Indonesia liquidity credit management to the government, Bank Indonesia's credit policy for promoting small and medium enterprises underwent a profound change. In addition to providing increased technical assistance to small and micro enterprises, Bank Indonesia's credit policy aims to promote diversification of bank credit portfolios to increase the share of small and micro enterprise credit, while facilitating development of a baseline economic survey and export-oriented agroindustry information system.

The performance of non-bank financial institutions improved in 2000 as the economy began to recover. With rising household consumption, the distribution of credit from non-bank financial institutions improved somewhat relative to the previous year. The slow recovery of bank lending activity also provided an opportunity for pawnshops to fulfill short-term household credit needs.

Payment System Policy and Development

During 2000 Bank Indonesia continued to make improvements to create an efficient, fast, safe and reliable national payment system to support the effective implementation of monetary policy and to support efforts to create a sound banking system. Defined broadly, payment system policy consists of currency circulation policy and policy to improve Bank Indonesia's service in providing a smoothly functioning payment system.

With respect to currency circulation activity, Bank Indonesia strove to fulfill the needs of the public for banknotes and coins for transaction purposes and to ensure that the physical condition of currency circulated by Bank Indonesia was appropriate. Bank Indonesia increased the supply of currency in 2000 to meet the growing needs of the public for cash of sufficient quantity and quality. The increased demand for cash, in addition to being due to economic growth, was also for precautionary purposes, particularly in the approach to certain critical dates in 2000 and for the celebration of religious holidays.

The quantity of currency in circulation tended to rise in 2000, reaching Rp89.7 trillion by the end of December, an in-

crease of 23.6% from Rp72.6 trillion one year earlier. This increase was mainly caused by large cash withdrawals during the month of Ramadhan, and around the time of Christmas and Idul Fitri, all of which occurred at almost the same time in November and December 2000.

In terms of the type of currency, there was not much difference between the growth of banknotes and coins, with the share of banknotes at 98.5% and the share of coins at 1.5% of total currency. However, currency in circulation was dominated by Rp100,000 and Rp50,000 notes, with these two denominations accounting for 58.5% of total currency in circulation in the year 2000.

In addition to supplying a sufficient quantity of currency, Bank Indonesia continuously strives to ensure that the quality of currency in circulation is appropriate by destroying banknotes no longer fit for circulation or by marking it as unworthiness banknotes and replacing it with new banknotes.

To overcome the significant growth of counterfeit currency in 2000, Bank Indonesia took preventative and repressive measures. Preventative measures included revolving from circulation denominations that are frequently counterfeited, such as the 1993/95 Rp50,000 note (the Soeharto series), the 1992 Rp20,000 note (the Cendrawasih series) and the 1992 Rp10,000 note (the Hamengkubuwono IX series). In addition, Bank Indonesia disseminated information about the features of authentic banknotes through the print-media, bulletin boards, and workshops. Coordination among concerned parties was also increased. Repressive activities were carried out by coordinating with responsible institutions to apprehend and bring to justice parties involved in counterfeiting rupiah banknotes.

In the payments system, policies relating to the non-cash payment system included continuing measures to develop a Real Time Gross Settlement (RTGS) system, improvement of various regulations dealing with the payment and clearing system, and increasing the security of all components of Bank Indonesia's computer network (BI-Net) as part of the implementation of RTGS and an audit of the BI-Net.

In the year 2000, the value of transactions using the non-cash payment system increased sharply, including both paper-based transactions and electronic transactions. By the end of 2000 the nominal value of nationwide clearing activity had increased by 41.7% relative to 1999, while the nominal volume of paper-based clearing activity decreased by 7.9%. A significant increase in nominal clearing activity took place in the fourth quarter of 2000 mainly due to a series of religious holidays at the end of the year. The decrease in the volume of paper-based clearing activity in the fourth quarter could be interpreted as an initial indication that implementation of the RTGS system by Bank Indonesia was received with enthusiasm by the national banking industry. This was indicated by shift of large value clearing activities within the Jakarta clearing area from Jakarta Automatic Clearing and the Electronic Clearing System to the BI-RTGS system.

Economic Prospects and Policy Directions for 2001

Macroeconomic Condition

Indonesia's economic prospects in 2001 are expected to improve in line with various positive developments, both domestic and external, as indicated by survey results and by Bank Indonesia's Index of Leading Economic Indicators. Externally, the global economy is expected to continue to grow, with world growth projected at 4.2%, down slightly from 4.7% in 2000. Slower economic growth is expected to occur mainly in North America and in several parts of Europe. However some countries, particularly Japan, are expected to experience strong economic growth, which should have a positive impact on the investment climate and on exports from Indonesia, through foreign company subsidiaries and joint venture companies operating in Indonesia.

With a slight decline in world economic activity and the continued high price of oil, the volume of world trade will grow more slowly. Inflation in industrial countries is expected to decline in 2001, and international interest rates are expected to remain relatively stable, thereby promoting capital flows to emerging markets, including crisis economies along with expected improvements of credit-ratings.

In light of these external conditions and given economic growth of 4.8% in the year 2000, Indonesia is expected to achieve an economic growth rate of 4.5%-5.5% in 2001. This moderate rate of growth will be a continuation of the ongoing recovery process. On the supply side, all sectors are expected to record positive growth in 2001, with manufacturing, trade and construction continuing to be the engines of growth. On the expenditure side, exports and investment are expected to continue to be the main sources of growth. It is expected that the relatively low level of real interest rates and continued recovery of the bank intermediation function will stimulate increased capacity utilization or additions to existing capacity, both for the domestic economy and for exports.

Meanwhile, along with higher investment and relatively strong export growth, imports are also expected to grow, particularly imports of components, raw materials and capital goods. With these developments, the current account surplus is expected to decline slightly to between 2.0% and 4.0% of GDP. However, Indonesia's overall balance of payments is expected to remain in a sound position. The foreign debt burden is expected to start declining in 2001, with private foreign debt in particular declining as a result of progress in debt restructuring. The capital account deficit is therefore expected to decline relatively to the deficit in the previous year.

Exchange Rate and Inflation

A relatively high level of risk and uncertainty, arising mainly from ongoing social, political and security problems, will continue to influence the exchange rate. Pressure on the exchange rate will continue, although overall the rupiah is expected to strengthen to an average annual level of Rp7,750 – Rp8,250 in 2001. Domestically, improvement of Indonesia's economic fundamentals in 2001, both in terms of economic performance and the commitment to undertake structural reform, is expected to raise confidence in the national economy. It is also hoped that the domestic political and security situation will become more conducive. Externally, the tendency toward slower growth in the United States in 2001 is expected to promote lower US dollar interest rates, which will restrict the global

appreciation of the US dollar. The real effective exchange rate of the rupiah is expected to remain competitive, which will continue to support the economic restructuring process and a more efficient allocation of resources.

In light of existing tendencies, upward pressure on the price level is expected to remain intense in 2001, due to the continuation of strong inflationary expectations, a declining output gap and strong pressure from the demand side. In addition, the government's plan to raise fuel prices, the floor price for rice, excises, civil servant salaries and regional minimum wages, is also expected to have an impact on inflation. There are also concerns that regional autonomy, which is beginning in 2001, will have an impact on inflation, particularly if the regions scurry to increase levies, fees and regional taxes. Consequently, efforts to reduce inflationary pressure must be preemptive, but must not disrupt the economic recovery process.

Inflation Target

With due consideration to the development and prospects of the national economy and taking into account price development that can be influenced by monetary policy, Bank Indonesia sets the inflation target for 2001, excluding the impact of the government's price and incomes policy, at 4.0%-6.0%. The impact of the central government's price and incomes policy, based on measures already identified such as increased wages for civil servants, the military and the police, higher regional minimum wages, reduced fuel subsidies, a higher floor price for rice, and higher excises, is expected to add around 2.0%-2.5% to inflation over and above the target.

Future Challenges

The outlook for the economy, the exchange rate and the inflation target discussed above will be dependent greatly upon progress in resolving various fundamental problems in the economy and on the development of certain factors contributing to risk and uncertainty. Efforts to overcome these factors will be the key to success in guaranteeing better economic recovery prospects in 2001 and in coming years. Risk and uncertainty factors include :

- **First**, the possibility that the domestic political and security situation will continue to be shadowed by uncertainty. Continued uncertainty could cause further increases in Indonesia's country risk, could delay and make uncertain in the resolution of various economic problems, and could incite speculative activity in the foreign exchange market.
- **Second**, continued delays in the process of corporate debt restructuring. This problem has already prevented economic activity and bank lending activity from recovering more quickly, since the majority of companies involved in the process of debt restructuring represent the largest share of the economy.
- **Third**, the slow recovery of the bank intermediation function. Bank lending is still limited because of the high level of risk and uncertainty, the large number of companies still undergoing debt restructuring, and the internal condition of banks. This situation greatly limits funding for economic activity, resulting in a situation in which most economic activity is self-financed from retained earnings. In addition, banks have little incentive to attract new funds, which results in low bank deposit rates and encourages the public to use their savings for consumption or for other types of investment.
- **Fourth**, the government's fiscal burden still high, mainly due to subsidies and interest payments on debt. Progress in asset recovery by IBRA and privatization of state-owned enterprises is less expected to alleviate the fiscal burden. The potential fiscal stimulus for promoting economic recovery will therefore remain very limited.
- **Fifth**, smooth implementation of regional autonomy, which begins in 2001, will be the key to the success of the economic recovery process and to the equalization of development in the future. Threats to economic recovery and price stability will arise if regional expenditures are uncoordinated or if regions scurry to increase levies, fees and regional taxes.
- **Sixth**, legal uncertainty in Indonesia. A number of legal cases still require legal system reform, including law enforcement, mainly through enforcement of the bank-

ruptcy law and complete reform of judicial institutions in Indonesia.

- Seventh, looking at external factors, there is the risk of a hard-landing for the American economy, which has served as an engine of growth for the world economy. Slower growth in the United States could threaten the optimistic outlook for Indonesian exports, which are expected to be a key source of economic growth in 2001.

Policy Directions

Considering economic prospects in 2001 and the inflation target set by Bank Indonesia as well as various challenges that have arisen, Bank Indonesia will strive to adopt policies in the monetary, payment system and banking sectors in a consistent and prudent fashion.

In light of these challenges, Bank Indonesia's monetary policy will continue to be directed toward controlling inflationary pressure and stabilizing the exchange rate, through exercising control over monetary instruments with reference to the base money target. To attain the inflation target, Bank Indonesia is convinced that the growth rate of base money consistent with the inflation target but does not pose excessive risk to the recovery of the banking system or the overall economy is in the range 11.0%-12.0%. This base money growth target is based on the level of base money in December 2000, after eliminating significant seasonal factors in that month.

Attaining this target for monetary instruments will still refer to implementation of open market operations through the SBI auction. In general, the monetary control strategy in 2001 in support of open market operations will include the following measures :

- (i). For the time being, open market operations using rupiah interventions will be optimized to support attainment of the base money target set by Bank Indonesia, without requiring an excessive increase in SBI interest rates.
- (ii). Sterilization using foreign exchange will remain an open option particularly to absorb excess liquidity in the market resulting from increases in government spending financed from offshore sources.

(iii). At the appropriate time, treasury bills and government bonds, which are expected to be actively traded in the secondary market, will be used as monetary instruments to replace SBIs.

(iv). Exchange rate policies that can directly reduce exchange rate volatility will remain open options while continuing to be based on a floating exchange rate and a free foreign exchange system.

In the banking sector, Bank Indonesia's policies will aim to protect the accomplishments of the bank-restructuring program and to restore the bank intermediation function, while continuing to uphold prudential principles in managing the national banking system. Bank Indonesia will encourage banks to increase risk management by setting forth risk management guidelines. As a condition for risk management and risk based supervision, the information system of banks must be upgraded. At the same time, in connection with the separation of the bank supervision authority from Bank Indonesia as set forth in Act Number 23/1999 on Bank Indonesia, Bank Indonesia continues to carry out preparatory measures so that the transfer of the supervision function will proceed smoothly without causing any disruption to the banking system.

To support the effective implementation of monetary policy and to accelerate the recovery of the banking industry, payment system policies will be aimed at speeding up the development and implementation of an efficient, accurate, safe and reliable payment system by enhancing the quality of service. One way to achieve this is through the implementation of the Real Time Gross Settlement system (RTGS) that began to be implemented in 2000. In addition, to increase bank efficiency and accelerate the inter-bank clearing process, Bank Indonesia will implement the Bulk Interbank Payment System (BIPS) in 2001, which involves special clearing for bulk transactions to accelerate other inter-bank trans-

3) Bulk transactions are routine inter-bank transactions with high volume but low nominal value such as wage and salary payments, credit card payments, insurances payments, installments on loans, and utility bills.

actions already carried out through the clearing system³⁾. Meanwhile, to increase the efficiency of the booking and switching process at banks operating automatic tellers (ATMs), and to make ATMs easier to use and more secure, Bank Indonesia will facilitate and encourage (in the form of moral suasion) banks operating ATMs to be integrated in a single network.

Conclusion

The series of policy measures these have been, or will be, carried out by Bank Indonesia constitute the concrete realization of Bank Indonesia's commitment to faithfully implement the mandate contained in Act Number 23 of 1999 on Bank Indonesia. To more effectively fulfill its mandate, Bank Indonesia has already adopted various policy measures relating to internal management to provide fast, precise and reliable support in implementing its duties in the monetary, payment and banking sectors. Internal management support with increasingly high quality is reflected in various policies that have been implemented and reported in regular quarterly reports submitted to Parliament and subsequently published. In addition to improvements in organization and human resource development, policies already adopted include raising internal financial management, developing the information technology system, improving legal policies, improving the internal audit management system, developing the public relations program, document management and improving logistics management.

Significant progress was also achieved in 2000 in resolving Bank Indonesia Liquidity Support (BLBI). In the working meeting of October 10, 2000, Commission IX of Parliament requested the government and Bank Indonesia to immediately resolve the Rp144.5 trillion BLBI problem. Agreement to resolve this problem was reached on November 17, 2000 with a decision to share the financial burden between the government and Bank Indonesia. Taking into consideration Bank Indonesia's financial capacity, it was agreed that Bank Indonesia would be responsible for Rp24.5 trillion of the BLBI thus the government would not need to recapitalize Bank Indonesia. This was accomplished by issuing Bank Indonesia note (SU-BI) to the government on

December 5, 2000, with the new bonds having the same conditions as government bonds (SUP) Number 1 and Number 3. As part of this agreement, the government clarified that it would not withdraw bonds already issued to Bank Indonesia in connection with the transfer of BLBI. With this agreement on Bank Indonesia Liquidity Support, the credibility of and confidence in Bank Indonesia should rise, supporting Bank Indonesia's strategic role in developing the national economy (Box: Resolution of Bank Indonesia Liquidity Support (BLBI)).

Bank Indonesia also carried out measures to divest its ownership of several banks and companies in 2000, as required in Act Number 23 of 1999 on Bank Indonesia. These measures included selling shares in PT. Bank Niaga and PT. Bank Utama. Other divestment measures still in progress include divestment of Bank Indonesia's ownership share in several banks, such as Indover Bank and PT. Bank Danamon, and in several companies such as PT. Askrindo, PT. Bahana and PT. Bina Usaha Indonesia (Box : Bank Indonesia Divestment Measures).

As mentioned previously, implementation of Bank Indonesia's duties was influenced by economic developments and by the domestic political and security situation. An important development that influenced implementation of Bank Indonesia's duties was the proposal raised at the end of the reporting year to amend Act Number 23 of 1999 on Bank Indonesia. This proposal, as is widely known, originated from the government, while Bank Indonesia's involvement in the amendment process was limited to providing expert opinion. In principle Bank Indonesia believes that it is not necessary to amend Act Number 23 on Bank Indonesia because this act was only recently passed into law. Some of the commentary about the Bank Indonesia Act was due to the fact that, as a new Act, it has not yet been sufficiently socialized. In this context Bank Indonesia believes that the single objective set forth in the Bank Indonesia Act, which is to attain and protect the stability of the value of the rupiah, as well as aspects of independence, should be maintained. The Bank Indonesia Act also basically contains aspects of accountability, such as performance, implementation of duties and authority, finances, ethics and legal sanctions. In addition, the

problem of coordination between the government and Bank Indonesia is also regulated firmly and clearly in the Bank Indonesia Act (Box : Amendment of Act Number 23 of 1999 on Bank Indonesia).

In conclusion, the series of policies to be adopted by Bank Indonesia in the year 2001 essentially constitute one part of the overall macroeconomic policy framework. The picture presented above of the prospects and policy direction to be adopted by Bank Indonesia will be very much dependent upon domestic political and security developments and on policy

measures in other sectors aimed at overcoming various problems and risk factors, as discussed previously. In addition, several important aspects such as the need for better coordination in formulating policies, the importance of cultivating a unified view and deeper cooperation between the government and Bank Indonesia, as well as with certain other related institutions, are also very much needed to create a synergy between the various policy measures that will be adopted. It is hoped that in this way the confidence to the economy will grow steadily and that the momentum of economic recovery will gather strength.

Box : Resolution of Bank Indonesia Liquidity Support (BLBI)

The settlement of the Bank Indonesia Liquidity Support (BLBI) problem in 2000 was an issue that absorbed great deal of attention and required actions from many parties, including Bank Indonesia. This was due not only to the complexity of the matter but also to its implications for the state budget and for Bank Indonesia's balance sheet, as well as the legal implications of both the disbursement and the use of the BLBI funds. For Bank Indonesia, the settlement of the problem is an integral part of measures to restore credibility and public confidence in Bank Indonesia's performance of its duties as the central bank, which is crucial for the success of bank restructuring and the economic recovery.

To obtain clarification and to decide on the necessary steps to settle the matter, Parliament formed a working committee (Panja BLBI). In its report dated March 6, 2000, the committee stated that BLBI was government policy and was the responsibility of the government. Even from the point of view of financial responsibility, the government is responsible for rescuing Bank Indonesia against any liquidation threat, as Bank Indonesia's equity is a state asset. Parliament ordered the Attorney General, the police commander, the Supreme Court, and the Minister of Legal Affairs to quickly formulate a clear and transparent legal ruling to settle the BLBI problem and to settle violations of the legal lending limit. The leaders of Parliament gave their commitment to help bridge the difference between Bank Indonesia and the Finance Minister on the status of the BLBI in Bank Indonesia's balance sheet.

As a follow-up of the working committee's recommendation, Parliament ordered the Supreme Audit Agency (BPK) to conduct an investigative audit of the disbursement of BLBI funds by Bank Indonesia and the use of these funds by the recipient banks. Bank Indonesia welcomed the investigative audit by BPK as part of the effort to enforce Bank Indonesia's transparency and accountability. Bank Indonesia, however, was of the opinion that the results of the BPK audit did not provide a balanced judgment of the policy or the disbursement of BLBI. The BLBI policy was basically a policy taken by the government

during the economic crisis to overcome the banking and economic problems. The audit should therefore have placed proportionate emphasis on the reasons behind the BLBI policy.

Bank Indonesia is also of the opinion that the BPK audit placed too much emphasis on the compliance audit rather than on the policy audit. BPK failed to realize that Bank Indonesia was a mere executor of government policy, and acted based on the consideration that measures had to be taken to save the existence of the banking system at that time to avoid more severe social and economic problems. Many of the findings that were treated as irregularities by BPK were classified on the basis of implementation standards used by Bank Indonesia under normal circumstances, but the BLBI policy was a measure implemented in a time of crisis. Regarding the legal actions taken to settle the BLBI problems, Bank Indonesia will give full cooperation to support these actions by being open and cooperative to the efforts to enforce transparent governance, including the investigations by the Attorney General.

To accelerate resolution of the BLBI problem, the Parliament held a working meeting with Bank Indonesia on October 10, 2000. During the meeting, Commission IX of the Parliament told the government and Bank Indonesia to immediately find a comprehensive solution to settle BLBI amounting to Rp144.5 trillion in 30 days. Bank Indonesia and the government reached an agreement on November 17, 2000, under which they agreed to share the costs. Taking into account Bank Indonesia's financial capability, Bank Indonesia assumed Rp24.5 trillion of the cost and issued debt notes (SU-BI) to the government for this amount, with similar terms and conditions to the government's debt notes (SUP) No.1 and No.3 previously issued to Bank Indonesia. Consequently the government did not need to inject equity into Bank Indonesia. The government also reiterated that it would not withdraw the SUPs previously issued to Bank Indonesia.

The issuance of debt instruments from Bank Indonesia to the government (SU-BI) was based on the following considerations:

1. The SU-BI will not change any legal agreements secured by IBRA, and will not affect the legal position of asset recovery in the future.
2. The issuance of SU-BI took into account the potential monetary impact of resolution of the BLBI problem, especially the possibility of an increase in the amount of currency in circulation, which could happen if the BLBI problem was settled in different manner.

As a follow up to the agreement, on December 5, 2000 Bank Indonesia issued Rp24.5 trillion of SU-BI to the government. The SU-BI carries the same terms and conditions as the government's SUPs that had previously been issued to Bank Indonesia (SUP 001/MK/1998 and SUP 003/MK/1999). The SU-BI was submitted to the Finance Minister with letter No.2/2/DGS/DKI dated December 5, 2000. The maturity period of the SU-BI is 18 years and 2 months, and

it will mature on February 7, 2018 (including a three year grace period).

The SU-BI worth Rp24.5 trillion was recorded under Bank Indonesia's 2000 profit and loss statement as an extraordinary item and was presented in Bank Indonesia 2000 balance sheet as government rupiah lending. It is worth noting that although it was recorded in the 2000 profit and loss statement, Bank Indonesia still recorded a surplus. One consequence of the issuance is that Bank Indonesia must pay interest and principal to the government every six months starting February 1, 2001 and February 1, 2004.

With this solution to the BLBI problem finally achieved, Bank Indonesia's credibility and public confidence in the central bank are expected to increase, and it is expected that this will support Bank Indonesia's strategic role in expediting the economic recovery.

Box : Bank Indonesia Divestment Measures

Paragraph 2 Article 64 and Article 77 of Act Number 23 of 1999 on Bank Indonesia stipulate that Bank Indonesia is only allowed to hold equity in legal entities or other entities as required to support Bank Indonesia in carrying out its duties, with approval from Parliament. Equity participation not in line with this regulation must be divested within two years of the enactment of the Act, or by May 17, 2001. Equity participation by Bank Indonesia was initially intended to rescue banks, while equity participation in non-bank financial institutions was intended to support development of the domestic financial market and small and medium enterprises.

The divestment of Bank Indonesia equity is to ensure objective supervision of all banks by Bank Indonesia and to avoid conflicts of interest between Bank Indonesia's role as bank regulator and shareholder. The divestment had commenced gradually in 1994 through various mechanisms, such as partial or complete sale of equity, not injecting fresh equity, not taking part in rights issues, reducing subordinated loans, and rejecting the conversion of loans into equity.

Bank Indonesia has taken various measures to divest, thereby reducing its participation in various banks and non-bank financial institutions. Some of the measures include the divestment of Bank Indonesia's equity in PT. Bank Niaga and PT. Bank Utama, resulting in a decline of Bank Indonesia's equity participation from 11 companies to 9 companies.

Divestment of equity in other banks, such as Indover Bank, PT. Bank Danamon and several closed banks, and PT Bank Pacific (which is under liquidation) are in progress. The

divestment of Indover Bank is pending the results of a study by the Bank Indonesia Divestment Team with its financial advisor ABN Amro. Divestment of Bank Danamon is waiting for the rebound of the bank's share price. The divestment of closed down and liquidated banks is waiting the results of the Liquidation Team.

Divestment plans for three non-bank financial institutions (PT Askrindo, PT Bahana and PT Bina Usaha Indonesia) are being discussed in shareholders meetings in each company. They will appoint independent consultants to conduct due diligence on the companies.

As a result of the divestment program, Bank Indonesia's equity participation in some banks and non-bank financial institutions as of December 31, 2000 is as follows:

Bank Indonesia's participation in Banks and Non Bank Financial Institutions as of December 31, 2000

No.	Banks/NBFI	Share	
		Nominal (Rp)	%
1.	Indover Bank Amsterdam	53,905,437,110.00	100.00
2.	PT Bank Danamon (ex. PT Bank PDFCI)	10,889,285,000.00	0.003
3.	PT Bahana Pembinaan Usaha Indonesia	9,500,000,000.00	42.22
4.	PT Asuransi Kredit Indonesia	175,568,800,000.00	55.00
5.	PT Bina Usaha Indonesia	2,872,000,000.00	57.44
6.	PT Bank Papan Sejahtera (Frozen Bank)	4,462,474,000.00	5.76
7.	PT Bank Ficorinvest (Frozen Bank)	5,545,750,811.00	6.42
8.	PT Bank Uppindo (Frozen Bank)	14,238,000,000.00	23.20
9.	PT Bank Pacific (Liquidated Bank)	30,600,000,000.00	51.00

Box : Amendment of Act Number 23 of 1999 on Bank Indonesia

The draft Act on amendment to Act Number 23 of 1999 on Bank Indonesia was proposed by the government to Parliament on November 20, 2000. The reasons for the amendment was to restructure all state institutions including Bank Indonesia to support national economic development as stipulated in Act Number 25 of 2000 regarding the National Development Plan, the need for clearer accountability in the Bank Indonesia Act to enable Parliament and the public to exercise control over Bank Indonesia, and to guarantee the supremacy of act with regard to possible criminal cases that may emerge from the implementation of Bank Indonesia's duties.¹⁾

The amendment initially covered five articles, namely article 38 regarding the tasks and authority of Bank Indonesia's Board of Governors, article 43 regarding Bank Indonesia's Board of Governors Meeting, article 48 regarding the replacement of the members of Bank Indonesia's Board of Governors, article 54 regarding the relationship with the government, and article 75 on transitional rulings regarding the board of governors.

In response to the government's proposal, the Parliamentary factions expressed the view that if the government's proposal was intended to improve Bank Indonesia from an institutional perspective, and in terms of personnel and accountability, then the material submitted by the government did not yet reflect the stated intention. Consequently a more thorough amendment was deemed necessary, which would not be limited to the material submitted by the government.²⁾

As mentioned above, since the proposal to amend the Bank Indonesia Act came from the government, Bank Indonesia's participation in the process was limited to the provision of information. During the amendment process, Bank Indonesia provided its opinions and input to the special Parliamentary committee on Amendment of the Bank Indonesia Act, on December 7, 2000.

In principle, Bank Indonesia considers the amendment to be unnecessary, among other reasons because the Bank Indonesia Act had only recently been passed by Parliament and not all of the regulations in the Act had been followed up with subordinate decrees, so that Bank Indonesia had not been able to evaluate the shortcomings of the law. Bank Indonesia is also of the opinion that comments on the Bank Indonesia Act emerged from a lack of comprehensive knowledge of the Act due to the fact that the Act had not yet been properly socialized.

During the Parliamentary debate on the amendment of the Act, the issues to be covered by possible amendment widened, as all of the chapters in the act were evaluated, on the suggestion either of Parliament or the government. It is worth noting that all of the parties involved reiterated the need to preserve Bank Indonesia's independence in performing its duties and authority. Moreover, Bank Indonesia's single objective to achieve and preserve the stability of the value of the rupiah as stipulated in the Act will not be amended.

Regarding the content of the amendment of the Bank Indonesia Law, there are several important matters that require a careful response, namely the objective, accountability and coordination with the government. As stipulated in Article 7 of Act Number 23 of 1999, Bank Indonesia's single objective is to achieve and preserve the stability of the value of the rupiah. This single objective must be maintained because there is no ambiguity in determining and achieving this objective. Secondly, a focused objective will give clarity to Bank Indonesia's accountability. Although the Act focuses Bank Indonesia's objective on achieving and preserving the stability of the value of the rupiah, in its implementation Bank Indonesia must also consider macroeconomic development. Moreover, the stability of the rupiah is a prerequisite for sustainable economic growth. Consequently, the addition of the sentence "taking into account its impact on the real sector" is unnecessary in the amendment of the Article 8 of the Act.

To secure the effective implementation of Bank Indonesia's tasks and authority, Bank Indonesia's indepen-

1) According to the government's statement in front of the Parliament Plenary Session November 27, 2000

2) Parliamentary factions' opinions on the government proposal to amend Bank Indonesia Act

dence as stipulated in Article 9 of the Bank Indonesia Act must be preserved. The article is aimed at establishing Bank Indonesia's institutional and functional independence by prohibiting external intervention. To avoid the impression that the chapter is ambiguous and exaggerate Bank Indonesia independence, the article could be amended, particularly those sections that address the definition and criteria of intervention and the mechanism and authority for judging intervention. If Article 9 is to be removed, sub-article 2 of article 4 and the clause on sanctions stipulated by articles 67 and 68 must be maintained. Otherwise, Bank Indonesia's independence will be meaningless.

Independence without accountability and transparency could make the central bank untouchable by law. In view of this matter, the Bank Indonesia Act creates a balance between Bank Indonesia's independence and accountability by requiring Bank Indonesia to uphold public accountability and transparency. The Bank Indonesia Act already requires accountability, addressing performance, the implementation of duties and authority, financial matters, ethics, and criminal penalties.

Accountability with respect to Bank Indonesia's performance (Article 7) is manifested by announcing at the beginning of the year the results of the evaluation of the implementation of monetary policy in the previous year, and the policy direction and monetary targets for the new year (article 58 sub-article 1). Bank Indonesia must also submit reports Parliament and the President (article 58 sub-article 2). Bank Indonesia is required to report its performance to Parliament every three months (Article 58 sub-article 3). Parliament is also authorized to instruct BPK to conduct a special audit of Bank Indonesia whenever necessary (Article 59).

Bank Indonesia's financial accountability is divided into ordinary financial and budgetary categories. Ordinary financial accountability is by reporting Bank Indonesia's annual financial report to BPK (Article 61), while budget accountability

is manifested by reporting the annual budget to Parliament (Article 60).

Regarding moral and ethical accountability, the Bank Indonesia Act stipulates that candidates for the Board of Governors must have high moral and personal integrity. This issue is further stipulated by the Board of Governors Decree on guidelines regarding the implementation of Bank Indonesia's policies and basic moral and ethical principles that must be obeyed by the Board of Governors.

To enforce legal accountability, the Bank Indonesia Act rules that the members of Bank Indonesia's Board of Governors, as Indonesian citizens, are not immune to the law. The principle of equality before the law is also enforced for legal violations. However, immunity in relation to the implementation of Bank Indonesia's tasks must be clarified. This means the members of the Board of Governors and Bank Indonesia staff cannot be held responsible individually for decisions and for implementing Bank Indonesia's policies with good intentions. The responsibility rests with Bank Indonesia.

To harmonize Bank Indonesia's monetary policies with the government's fiscal and other policies, the Bank Indonesia Act clearly requires close coordination with the government. This matter is specifically stipulated in Chapter VIII and its articles, especially Article 43 concerning the monthly meeting of Bank Indonesia's Board of Governors which can be attended by one or more ministers who represent the government and are allowed to speak at the meeting without voting rights.

So far Bank Indonesia's relationship with the government has run well. Bank Indonesia has held regular coordinating meetings with the government (economic ministers) every month to coordinate various policies that have been implemented and to discuss problems that need joint solutions. With regard to this matter, it is worth considering the mechanism for announcing the results of these meetings with the government to the public.

Chapter 2

Macroeconomic Condition



The Indonesian economy experienced a more solid recovery process in 2000 with a more balanced growth structure. All economic sectors and activities contributed positively to growth of Gross Domestic Product (GDP). GDP grew by 4.8% in 2000, which was significantly better than the growth rate expected at the beginning of the year of between 3.0% and 4.0% (Table 2.1)

Nonetheless, the economic recovery continued to encounter several fundamental problems that impeded growth, such as the unfinished bank, credit, and corporate restructuring process, which were further stymied by high social, political and security uncertainty. These problems inhibited new investment, which is crucial for sustainable economic growth, although investment growth during the reporting year was fairly high. Moreover, heavy financial burden faced by the government, especially for debt payment and subsidies, limited the fiscal stimulus available to accelerate the economic recovery.

On the demand side, the engine of growth shifted from consumption to exports and investment, both of which made significant positive contributions to the growth. On the supply side, all sectors had experienced positive growth, with manufacturing making the largest contribution to GDP growth.

Macroeconomic improvement also reduced open unemployment. The number of layoffs and the number of cases settled in court declined. Despite persistent inflationary pressure, economic growth and the government's policy to increase salaries for civil servant, the military, the police and to raise regional minimum wages, led to higher real income for workers.

Aggregate Demand

Unlike growth in the previous year, which was driven solely by consumption, economic growth from the expenditure side in 2000 was propelled by exports, followed by investment and consumption. The contribution to GDP growth from exports, investment and consumption came to 3.9%, 3.6%, and 3.1% respectively. Strong export performance and a rising contribution from investment indicated that more solid economic growth was taking place.

Exports of good and services grew by 16.1% during the reporting year and contributed 3.9% to GDP growth. This was a sharp increase compared to a contraction of 31.6% stated in the previous year. Export growth was driven mainly by a rise on non-oil and gas exports, especially exports of industrial goods and mining. The high export growth was mainly due to strong global demand, the competitiveness of Indonesian export products and the government's policies to support exports. Moreover, Bank Indonesia also issued a regulation on provision of international trade financing guaranty, executed through commercial banks.¹⁾ In line with export growth, imports of goods and services

1) PBI Number 2/13/PBI/2000 dated May 16, 2000 on the guarantee of international trade financing.

Table 2.1
Gross Domestic Product

Item	1998		1999*		2000**	
	Growth	Share	Growth	Share	Growth	Share
	Percent					
GDP (Real)	-13.1	-13.1	0.8	0.8	4.8	4.8
By Expenditure						
Consumption	-7.1	-5.1	4.3	3.3	3.9	3.1
- Private	-6.2	-3.9	4.6	3.2	3.6	2.6
- Government	-15.4	-1.1	0.7	0.0	6.5	0.5
Investment	-33.0	-10.6	-19.4	-4.8	17.9	3.6
Export	11.2	3.1	-31.6	-11.3	16.1	3.9
Import	-5.3	-1.7	-40.7	-14.3	18.2	3.8
By Sector						
Agriculture	-1.3	-0.2	2.7	0.5	1.7	0.3
Mining	-2.8	-0.2	-2.4	-0.2	2.3	0.2
Manufacturing	-11.4	-2.8	3.8	1.0	6.2	1.6
Electricity	3.0	0.0	8.3	0.1	8.8	0.1
Construction	-36.4	-3.0	-0.8	0.0	6.7	0.4
Trade	-18.2	-3.1	0.1	0.0	5.7	0.9
Transportation	-15.1	-1.1	-0.8	-0.1	9.4	0.7
Financial Institutions	-26.6	-2.4	-7.5	-0.6	4.7	0.3
Services	-3.8	-0.3	1.9	0.2	2.2	0.2

Source : BPS-Statistics Indonesia

rose 18.2%. Import growth was closely linked to the growth of investment and high export-oriented industries with high import contents, especially for raw materials and capital goods.

The second largest contributor to growth was investment, which grew by 17.9% and contributed 3.6% to GDP growth. Investment growth represented a sharp increase after declining in the previous years. Despite the high growth rate of investment, the nominal level of investment in the reporting year was still low compared to pre-crisis levels. Investment growth was reflected in the increase of import on raw material and capital good. Investment growth signaled that the process of economic recovery was on the right track and sustainable. Bank Indonesia's survey of business activity showed rising investment activities as reflected by the fact that the weighted net balance of businesses undertaking investments in 2000 was still positive and on a rising trend (Chart 2.1). This positive weighted net balance indicated that more businesses implemented their investment plans during the reporting year.

The main source of financing for investment appears to have been self-financing, as bank financing was still limited. The source of self-financing was from accumulated export revenue which was mostly parked overseas. This was because

of high levels of domestic risk and uncertainty, as well as various export financing facilities provided by foreign banks.

The relatively limited amount of domestic bank credit was due to the persistence of internal problems in domestic banks associated with the capital adequacy ratios (CAR) fulfillment and legal lending limit violations. In addition, external factors, such as the limited number of potential borrowers caused by the fact that most of debtors were still in debt restructuring negotiations with IBRA and the strict risk criteria that banks implemented when providing new loans, limited the amount of new bank credit. Nonetheless, bank credit channeling grew significantly in 2000, especially during the second half of the year, from Rp277.3 trillion at the end of 1999 to Rp320.4 trillion in the end of 2000. New loans were provided mainly by A-category banks --namely banks with CARs above 4.0%-- along with foreign and joint venture banks, whereas loans from state banks and banks under the recapitalization program were still very limited.

All the problems mentioned earlier hindered the potential domestic source of financing being channeled as investment. It was reflected by the large gap between saving and investment in the reporting year (Chart 2.2). The saving-investment gap as a share of GDP rose from 4.1% in 1999 to 5.0% in 2000 (Table 2.2). The growth of the saving-investment gap came from the private sector, with the private sector's savings-investment gap rising from 5.1% to 7.2% of GDP. The government's saving-investment gap remained in deficit and the deficit actually increased from 1.1% to 2.2% of GDP.²⁾

The increase in the private sector's saving-investment gap was mainly due to the fact that saving rose faster than investment in the private sector. The rise in saving was in line with the increase of savings in the banking system. This was a positive development, particularly in light saving-investment surplus in the previous years mainly due to the fact that investment decreased more rapidly than saving. However, investment growth still faced certain obstacles, including high domestic risk stemming from the unstable domestic social, politi-

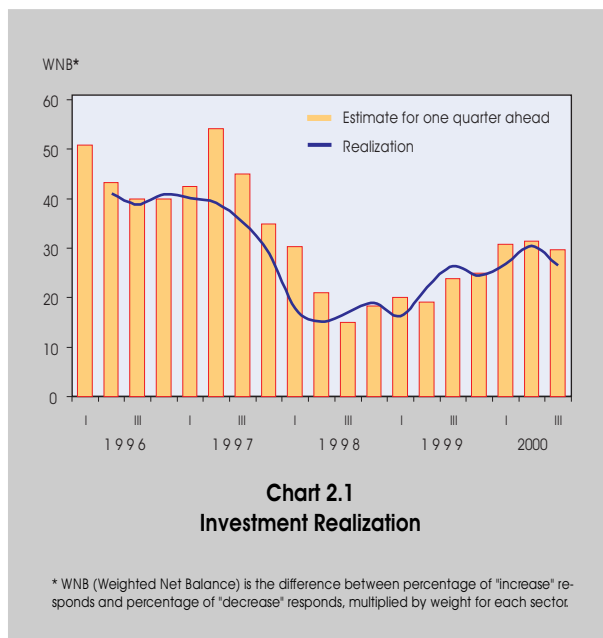

2) The calculation of the government saving-investment gap was based on calendar year as opposed to fiscal year.

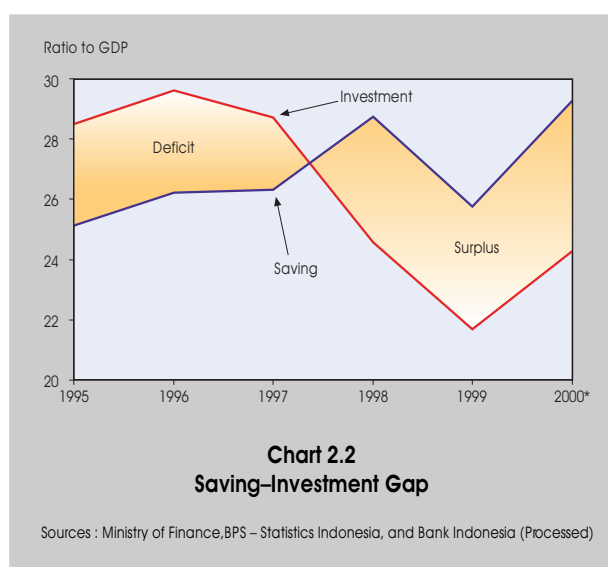

cal and security situation, as well as a low level of legal certainty.

On the government side, the rising saving-investment deficit was because government saving fell more rapidly than government investment. The decrease in government saving was mainly caused by a large payment on fuel subsidies arising from a delay in subsidy reduction, and an increase in fuel import volume and value, as well as an increase in interest payments on government bonds. The drop in investment was due to the fact that most of the state budget had to be allocated to non-discretionary expenditures such as central and regional civil servant expenditures, debt service and subsidies.

The rising surplus in the saving-investment gap indicated that domestic financing could potentially play a larger role in bolstering economic growth, but the potential could not be tapped optimally due to problems in the banking sector that inhibited growth of new lending. The slow growth of lending to the real sector was closely linked to slow progress on debt restructuring and the limited number of creditworthy businesses. These domestic problems certainly must be solved immediately to facilitate the economic recovery. At the same time foreign financing sources to boost domestic investment are limited by the unfavorable domestic investment climate. The limitations on foreign financing were reflected in the capital account, which con-

tinued to record a deficit mainly due to reduced net capital inflows from government borrowing.

Consumption provided the third largest contribution to GDP growth. During the previous year consumption had been the only category on the expenditure side of the national accounts to record positive growth. Consumption grew by 3.9% in 2000 and contributed 3.1% to GDP growth. The increase in consumption was driven by household consumption, which grew by 3.6% and contributed 2.6% to GDP growth. Government consumption rose more rapidly, increasing by 6.5% relative to the previous year, but contributed only 0.5% to GDP growth.

The robust increase in private consumption was due to improved income, the resumption of consumption credits, and

Table 2.2
Saving-Investment Gap

	1998	1999	2000
	Trillions of rupiah		
Government			
Saving	48.0	62.9	36.1
Investment	49.8	74.2	64.4
Deficit (-), surplus (+)	-1.8	-11.3	-28.3
Private			
Saving	236.4	222.8	342.5
Investment	193.2	166.1	249.5
Deficit (-), surplus (+)	43.1	56.7	93.0
Domestic Saving Brutto	284.4	285.7	378.6
Investment	243.0	240.3	313.9
Saving-Investment Gap	41.3	45.4	64.7
GDP	955.8	1,110.0	1,290.7
	% of GDP		
Government			
Saving	5.0	5.7	2.8
Investment	5.2	6.7	5.0
Deficit (-), surplus (+)	-0.2	-1.0	-2.2
Private			
Saving	24.7	20.1	26.5
Investment	20.2	12.0	19.3
Deficit (-), surplus (+)	4.5	5.1	7.2
Domestic Saving Brutto	29.8	25.7	29.3
Investment	25.4	21.6	24.3
Saving-Investment Gap	4.3	4.1	5.0
Current Account (in billions of \$)	4.1	5.8	7.7
Note :			
Average Exchange Rate Rp/\$	10,088	7,850	8,400
(a) Excl. stock changes			
Sources : Ministry of Finance, BPS – Statistics Indonesia, and Bank Indonesia (Processed)			

high expectations of inflation that encouraged economic agents to spend for consumptions. Low saving and time deposit rates also caused strong consumer spending during the reporting year. The increase in consumption was reflected in several consumption indicators, such as cement consumption and vehicle sales. Cement consumption witnessed a sharp rise, especially during the second half of 2000 (Chart 2.3). This was in line with rapid growth in the construction sector, following a contraction in the previous years. A similar development took place for vehicle sales, which were on a strong upward trend (Chart 2.4). Besides reflecting rising consumption, the two indicators also reflected the concentration of private consumption on durable goods. Other consumption indicators, such as Bank Indonesia's Survey of Retail Sales, also displayed a rising trend (Chart 2.5). The retail sales index rose fairly sharp from the second quarter of 2000 after a downward correction due to seasonal factors following the end of school holidays.

Government consumption during the reporting year rose by 6.5%. Realized government spending reached Rp223.9 trillion, with 49.0% of this amount (Rp109.3 trillion) influencing aggregate demand in the form of government consumption expenditure and government investment, and 42.2% (Rp94.5 trillion) as transfers to the private sector in the form of subsidies and interests on government debt. Out of

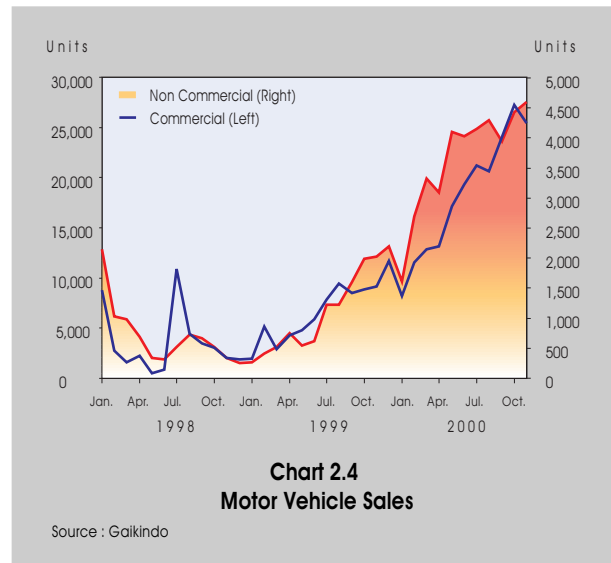

realized government spending that affected aggregate demand, 62.0% was in the form of government consumption expenditure and the remaining 38.0% was investment expenditure. In line with government expenditures, the state budget recorded a deficit of 3.2% of GDP in fiscal year 2000 (April-December 2000), lower than the projected deficit at the beginning of the year of 4.8% of GDP. The lower-than-expected deficit was due to higher-than-expected oil and gas revenue due to a rise in the price of oil on international markets. Meanwhile, most of government expenditure was in line with the budget.

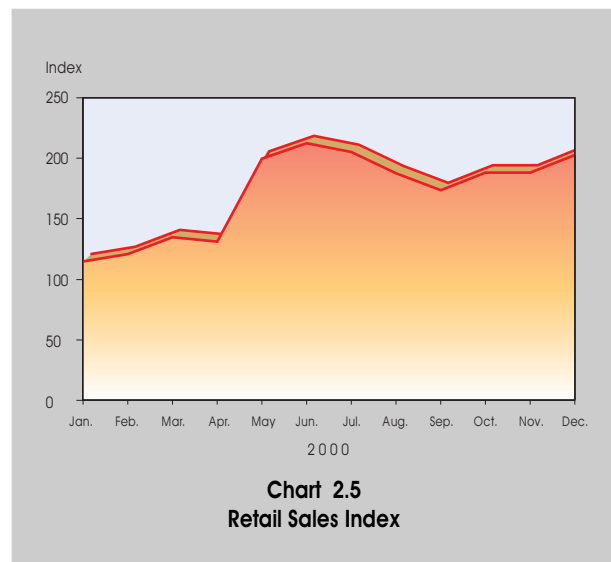
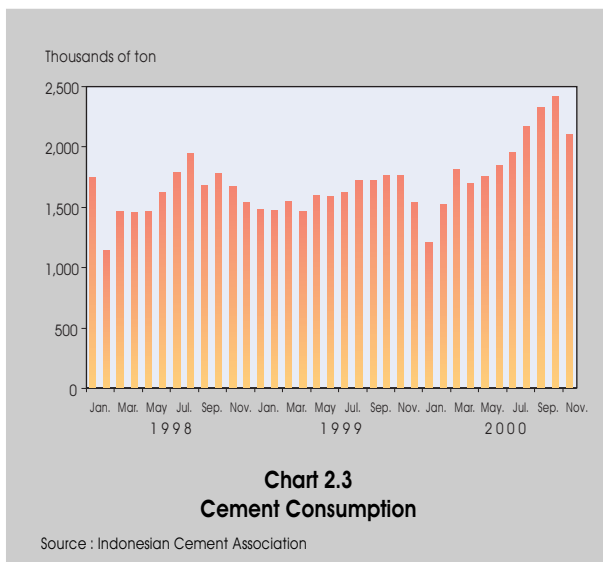

Aggregate Supply

On the supply side, the economic recovery also showed more promising signs with all sectors making positive contributions to growth, especially manufacturing which made the biggest contribution. However, given the investment contraction in the previous year, the growth of aggregate supply was not as rapid as the growth of aggregate demand. Moreover, new investment in 2000 was still low relative to the pre-crisis period. In addition, the drop in the level of installed capacity as a result of the crisis and various other obstacles, especially limited financing, also influenced the slowness of growth from potential output. The fact that potential output grew more slowly than demand --which in recent years was driven by consumption-- will create upward pressure on the general price level.

Short-term Supply

All economic sectors experienced positive growth in 2000. Manufacturing sector remained as the main engine of growth, followed by trade sector and transportation sector (Box: The Crisis and the Structure of the Indonesian Economy). The financial sector, which had contracted in the previous years, also recorded positive growth.

The manufacturing sector grew by 6.2% in 2000. Although the growth rate of manufacturing was lower than the growth rate of transportation, electricity, and construction, the share of manufacturing sector is larger than these other sectors and therefore made the greatest contribution to overall GDP growth. The strong growth of manufacturing was in line with rising demand, especially in the non-oil and gas sub-sector. The activities under non-oil/gas sub-sector that provided the greatest contribution to growth were transportation vehicles, machinery and equipment, and fertilizer, chemicals and rubber. The rising performance of the manufacturing sector was followed by rising imports of raw materials.

The rise in the manufacturing sector was also reflected in the results of a Production Survey of some manufacturing companies conducted by Bank Indonesia, with an increase evident in the production index (Chart 2.6). Out of the nine industrial groups surveyed, almost all of the groups experienced

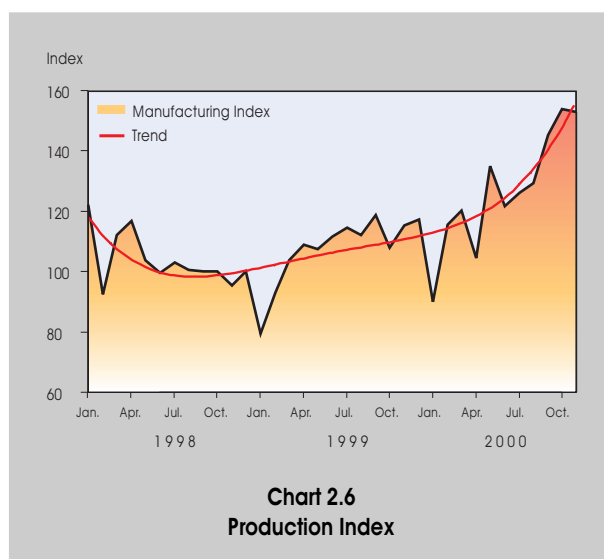

Chart 2.6
Production Index

growth, except the wood and rattan industry. The highest rates of growth were recorded in the metal industry, the miscellaneous manufacturing industry, and the food, beverage and tobacco industry.

The trade, hotel and restaurant sector also registered strong growth of 5.7%. The largest contribution in this sector came from trade, as reflected by the rising retail sales index (Chart 2.5). Hotel occupancy rates in Bali and Jakarta also rose, which provided a positive contribution to the growth of the hotel sub-sector and the restaurant sub-sector (Chart 2.7).

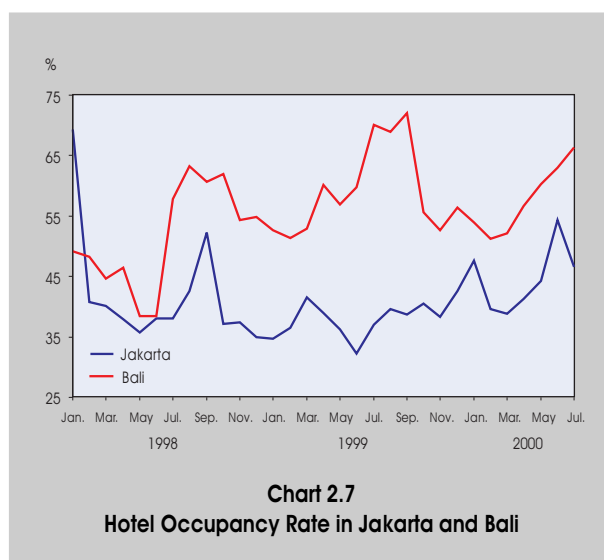
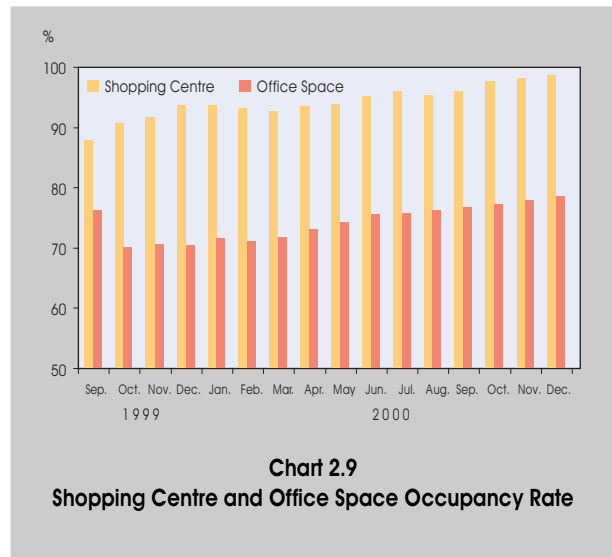
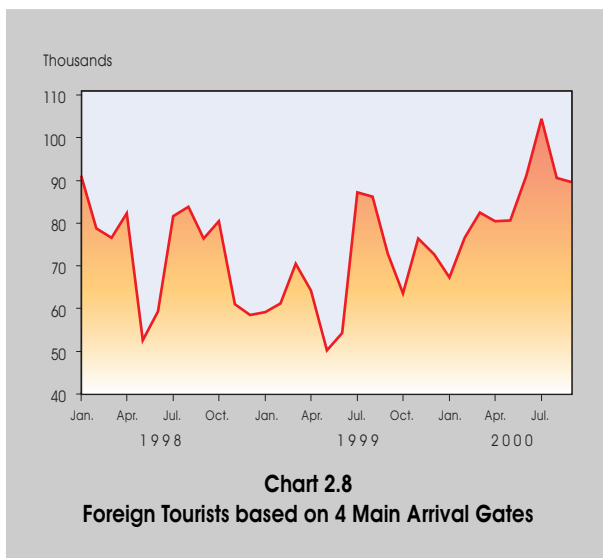

Chart 2.7
Hotel Occupancy Rate in Jakarta and Bali

The transportation and communication sector grew by 9.4% with the largest contribution to growth coming from the land transportation sub-sector. The growth in this sub-sector was closely linked to the fact that the Idul Fitri holiday occurred twice in 2000, as well as to the stability in the prices of spare parts after sharp increases in the price of spare parts caused a crisis in the sub-sector in previous years. The stability of the prices for spare parts was reflected in the rise of the index of vehicle and spare part sales in the retail survey. Transport growth was also supported by a rise in tourism, which was reflected by the rise in the number foreign tourists coming to Indonesia through four main arrival gateways (Chart 2.8). The commencement of several new airlines also supported growth in this sector.

After suffering the largest contraction at the beginning of the crisis, the construction sector recovered in 2000, with growth rising to 6.8% from a contraction of 0.7% in the previous year. The recovery of this sector was marked by a rising level of activity in the property sector, especially commercial property, in line with a rise in business activities. Demand for shopping center space in the greater Jakarta area and for office space in Jakarta showed a rising trend, as reflected in a high occupancy rates of commercial properties (Chart 2.9).

The agricultural sector grew by 1.7% in 2000, a slight decline relative to the previous year. Some reasons for slower



growth in this sector were the end of the plantation bonanza that took place at the beginning of the crisis, limited sources of financing for expansion, and rising prices of imported goods needed in agricultural production. An abundant supply of imported agricultural products also caused a slow down in growth in the food crop sub-sector. Low prices for food products such as rice, corn and sugar also discouraged farmers from cultivating their land.

Long-Term Supply

Long-term supply or potential output³⁾ during the reporting year started to show signs of improvement. As mentioned previously, there were several positive indicators, such as rising but still limited investment and growing employment, which boosted production inputs. In turn, such developments will increase potential output.

However, the growth of potential output was outpaced by the growth of actual output (demand). The lack interest in investment and the scarcity of financing for long-term investment curbed the growth of installed capacity. Meanwhile,

3) Potential output is calculated using Hodric- Prescott filter method. The method actually contains a shortcoming especially on the end-point problem. However, the method is widely used due to its practicality. The effort overcome the shortcoming was by including the GDP projection to 2003.

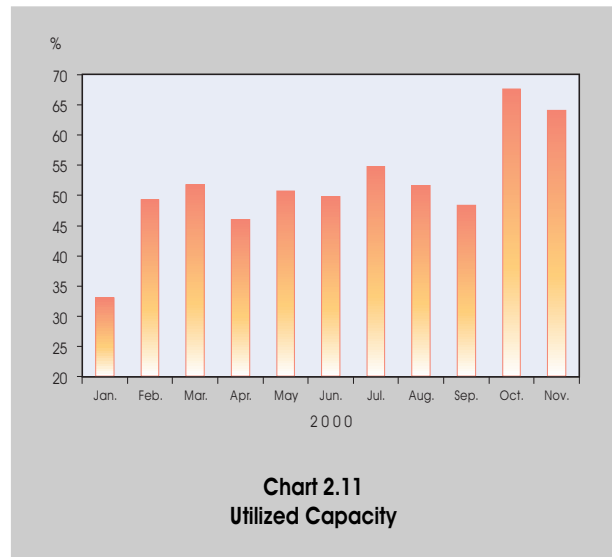
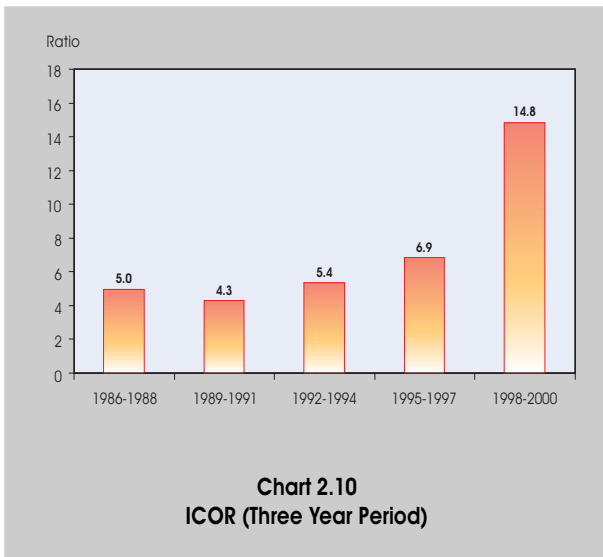

machinery and equipment that was left unused due to closure of factories and the high price of spare-parts accelerated the decline in installed capacity. The absence of a full recovery in long-term investment also hindered the acceleration of potential output growth. A non-conducive social, political and security situation helped complicate the problems blocking recovery of the Indonesian economy. Economic recovery was also impeded by low productivity and the slow recovery of the production chain. This was reflected in a high Incremental Capital Output Ratio (ICOR) during the 1998-2000 period (Chart 2.10).⁴⁾ It is worth noting that the sharp ICOR rise was a logical consequence of the low economic growth during the crisis.

At the same time, demand growth was accelerating, driven by consumption growth. This growth in demand was not fully matched by new investment, but by existing excess capacity, as could be seen from Bank Indonesia’s production survey that revealed an increase in the rate of capacity utilization (Chart 2.11). The high growth of actual demand un-

matched by growth of productive capacity will narrow the output gap, and this will create inflationary pressure (Chart 2.12).

Labor Issues

Labor conditions improved in line with an improvement in economic conditions, as reflected by a resumption of labor recruitment. The level of open unemployment --the ratio between the number of people experiencing open unemployment and the total workforce-- decreased as employment growth exceeded the number of new entrants into the labor force. The level of

4) Formula used to calculate ICOR between t₂ and t₁ :

$$ICOR_{t_2-t_1} = \frac{\sum_{t=t_2+1}^{t_1} GFCF_t}{GDP_{t_1} - GDP_{t_2}}$$

GFCF = Gross Fixed Capital Formation

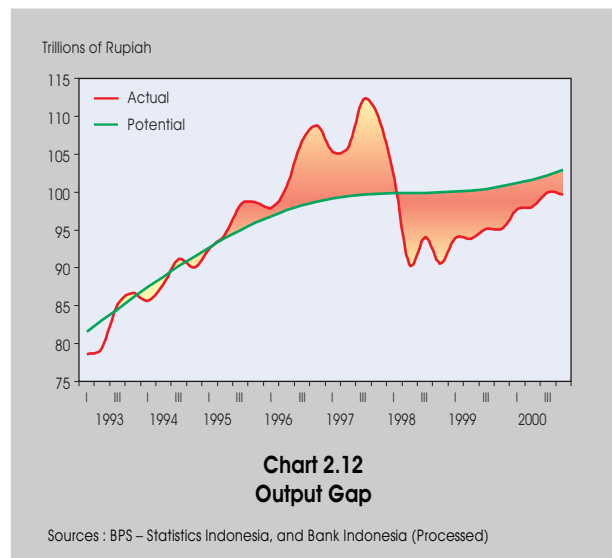

Sources : BPS – Statistics Indonesia, and Bank Indonesia (Processed)

Table 2.3
Manpower Indicators

Indicators	1998	1999	2000	Change 1999-2000 (%)
	In millions of person			
Working-age population	138.5	141.1	141.3	0.15
Labor force	92.8	94.8	95.7	0.95
Employed labor force	87.7	88.9	89.8	1.04
Unemployed labor force	5.1	6.0	5.9	-1.64
Unemployment rate (%)	5.5	6.4	6.1	-2.60
Labor force participation rate (%)	66.9	67.2	67.7	0.73

Source : Ministry of Manpower

open unemployment in 2000 was 6.1%, down from 6.4% in the previous year (Table 2.3). Another important indicator is the labor force participation rate, which measures the ratio between the number of people working or looking for work and the total working-age population. The labor force participation rate increased in 2000, indicating that the number of people working or willing to work increased relative to the total population of working age. In line with the decrease in open unemployment, the number of cases settled in court and layoffs fell (Chart 2.13).

Nonetheless, there were still a number of major challenges in labor affairs. Although unemployment decreased, the absolute number of unemployed people was still high, at 5.9 million individuals. The educational level of the labor force is

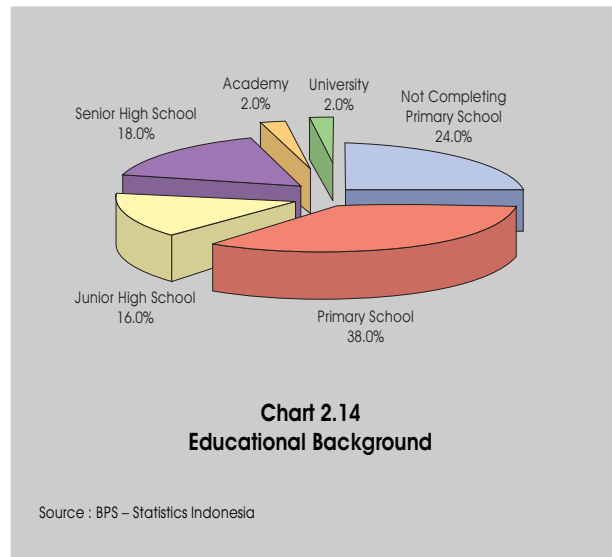

Chart 2.14
Educational Background

Source : BPS – Statistics Indonesia

low, with 38.0% of the workforce having only completed primary school (Chart 2.14). If this number is combined with those who did not complete primary school, the share of the labor force having a primary school education or less came to 62.0%. Those with education more than high school came to just 4.0% of the labor force.

Income rose in line with the fall in unemployment. The minimum regional wage (UMR) was increased by 25.0% in 2000 (Table 2.4). This development showed the government intention to improve the public welfare as reflected by the rising rate of the minimum wage increase (Chart 2.15). However,

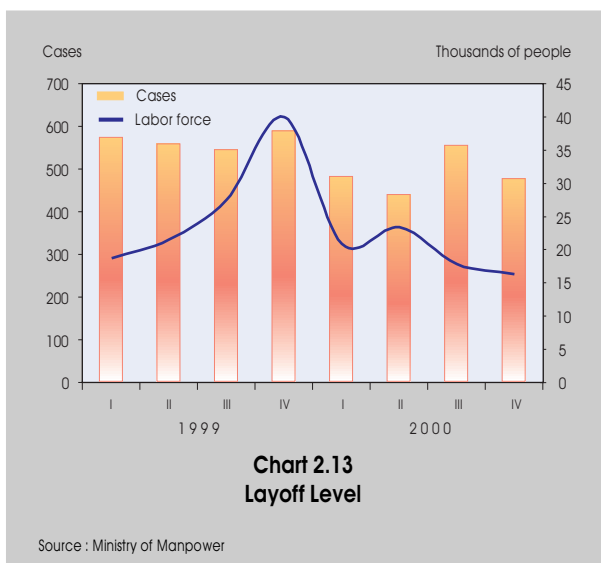

Chart 2.13
Layoff Level

Source : Ministry of Manpower

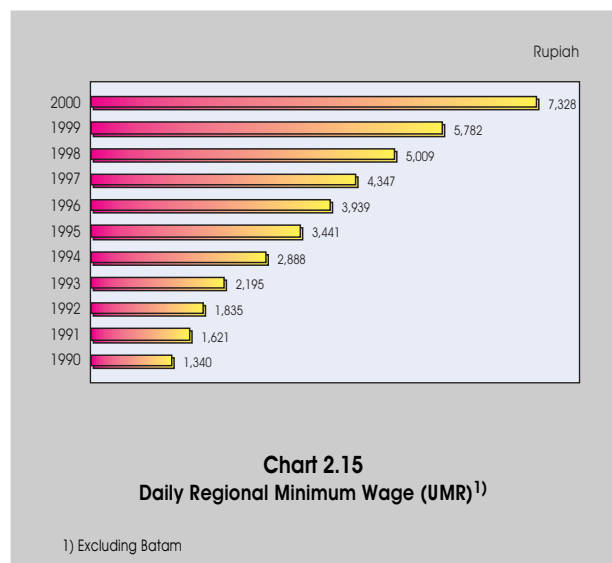

Chart 2.15
Daily Regional Minimum Wage (UMR)¹⁾

1) Excluding Batam

Table 2.4
Regional Minimum Wage (UMR) and
Minimum Living Requirements (KHM)

Year	UMR ¹⁾	KHM	UMR	KHM	UMR/KHM
	Rupiah per month		Change (%)		In percent
1996	118,170	130,501	57.9	37.9	90.6
1997	125,615	134,384	6.3	3.0	93.5
1998	144,491	194,161	15.0	44.5	74.4
1999	166,917	243,667	15.5	25.5	68.5
2000	207,752	251,634	24.5	3.3	82.6

1) UMR is calculated based on 30 working-days
Source : Ministry of Manpower

there was still a wide wage disparity between urban and rural areas as well as among economic sectors. The region with the highest minimum wage is Batam, followed by Jakarta, West Java and Irian Jaya, whereas the regions with the lowest minimum wages are Maluku, Jambi and Bengkulu. Despite the disparities distribution, the increase in the Regional Minimum Wage (UMR) was faster than the rise in the cost of Minimum

Table 2.5
Weekly Wage/Salary

Year	Nominal Wage			Real Wage		
	Thousands of Rp					
	Manufacturing	Hotel	Mining	Manufacturing	Hotel	Mining
I/99	67.8	74.1	200.1	32.9	35.9	97.1
II/99	75.4	77.7	246.8	36.8	38.0	120.6
III/99	73.1	78.1	202.1	36.5	39.0	100.9
IV/99	78.1	97.4	220.2	37.6	48.7	110.1
I/00	78.7	95.8	231.1	38.4	46.8	112.8
II/00	88.0	98.0	235.7	42.5	47.3	113.9
III/00	90.1	95.1	234.9	42.6	44.9	111.0

Source : BPS-Statistics Indonesia

Living Requirements (KHM), and as a result the ratio of UMR/KHM rose, which indicated an improvement in the public welfare. In addition to the rise in minimum wages, the government also raised civil servant, military and police salaries. The rise in economic growth also increased workers' incomes as reflected by the increase in the real wages of manufacturing and hotel workers (Table 2.5).

Box : The Crisis and the Structure of the Indonesian Economy

Under structuralism approach, economic development is a transitional and transformation process that includes changes in the structure and composition of national product and employment, inter-sectoral, inter-regional, and inter-group gaps, as well as poverty and income gaps.¹⁾ Simon Kuznets - the 1971 Economics Noble laureate - in his explanation of modern economic growth emphasized that developing countries generally have characteristics that basically include the growth in macroeconomic aggregates (per capita output, population, and productivity), structural transformation in those economic aggregates, and distribution arising from growth.

In the Indonesian case, various indicators showed that a structural transformation had taken place before the crisis hit in mid-1997, partly owed to liberalization measures in various economic sectors that the government introduced beginning in the early 1980s. After the crisis began in mid-1997, a question arose whether the Indonesian economic structure had experienced significant transformation. This article will focus on the transformation in the economy.

From the supply side, the structural transformation can be detected from the decrease in the share of traditional primary sectors in total GDP (agriculture and mining). The share of the secondary sector (manufacturing, electricity, gas and drinking water, and construction) rose followed by the tertiary sector (trading, hotel and restaurant, transportation and communication, banking and financial institution, and services). In this transformation process, changes in the shares of different sectors have to be coinciding with the positive growth of each sectors though at different rates. Experiences from developing countries indicate that the speed of transformation is different in each country depending on the economic characteristics of the respective countries. Countries with abundant natural resources experienced slower transformation relative to those less well endowed with natural resources. This difference is due to the fact that resource-rich countries need higher

growth in the primary sector to support the acceleration of growth in other sectors.

A chart of the shares of each sector in Indonesian GDP shows that the share of the primary sector was decreasing until the crisis emerged. At the same time, the shares of the secondary and tertiary sectors were on the rise. The share of the primary sector fell consistently from around 43.0% of GDP in the early 1980s to around 23.0% in 1997. The share of the secondary and tertiary sectors rose from 18.0% and 37.0%, respectively, to 34.0% and 42.0%. During the crisis this pattern was reversed, with the share of the primary sector rising to 26.0%. It is not yet known whether this reversal of the pre-crisis pattern or structural change is permanent or temporary.

The pre-crisis structural transformation was in line with general development patterns taking place in developing countries. The share of the secondary sector rose sharply after the enactment of banking deregulation in 1983, which initiated other economic and financial deregulation. An increase in the availability of financing led to investment in new manufacturing industries. After the introduction of the October 1988 Economic Package (Pakto 1988), which provided more room to the banking sector, the tertiary sector grew fast, particularly banks and non-bank financial institutions. Growth in the secondary sector, especially manufacturing, and in the next stage in the tertiary sector, driven by banking, was much higher than the growth in the primary sector. Consequently the share of the primary sector in total GDP fell sharply.

However, the acceleration of transformation itself created new problems. As a resource-rich country, Indonesia - learning from the experience of other developing countries - should not experience a drastic decline in the primary sector's share of GDP. The definition of the speed of the transformation, however, is not clear so that this concise article will not be concerned with the "precision" of the acceleration of growth but will emphasize more on how the transformation took place from the economic boom period until the recovery period.

As mentioned previously, the transformation of the Indonesian economy was triggered by rapid growth of manu-

1) Sumitro Djojohadikusumo, "Dasar Teori Pertumbuhan dan Ekonomi Pembangunan", Jakarta, June 1994, page 126.

facturing. The problems arose as the growth was driven by the development of manufacturing industries that were not based on natural resources in which Indonesia has a comparative advantage. The fast expansion of the secondary sector was focused on so called "mega-projects" and other less-competitive industries that yield a high return. Financing for these projects was obtained from foreign loans that could put pressure on the balance of payments and create potential repayment problems. This happened because of the protection given to these projects, which was made worse by distortions such as mark-up practices, corruption, collusion and nepotism, which caused a high-cost economy. Consequently these industries were not built on strong foundations. These imbalances in turn will require adjustments.

The crisis - which started with pressure on the rupiah exchange rate in the second half of 1997 - has changed the direction of the share of each sector in GDP. The share of the primary sector, which had declined consistently prior to the crisis, jumped up during the crisis. As Indonesia is a resource-rich country with a solid historical background in agriculture, the primary sector served as a bumper against the crash in economic growth during the crisis. This is shown by the rising role of the agricultural and mining sectors in the formation of GDP.

While the primary sector rose, the secondary and tertiary sectors declined as the bubbles that had developed in the past were corrected. The decline in the secondary sector was not drastic, as it was cushioned by the rise in the food,

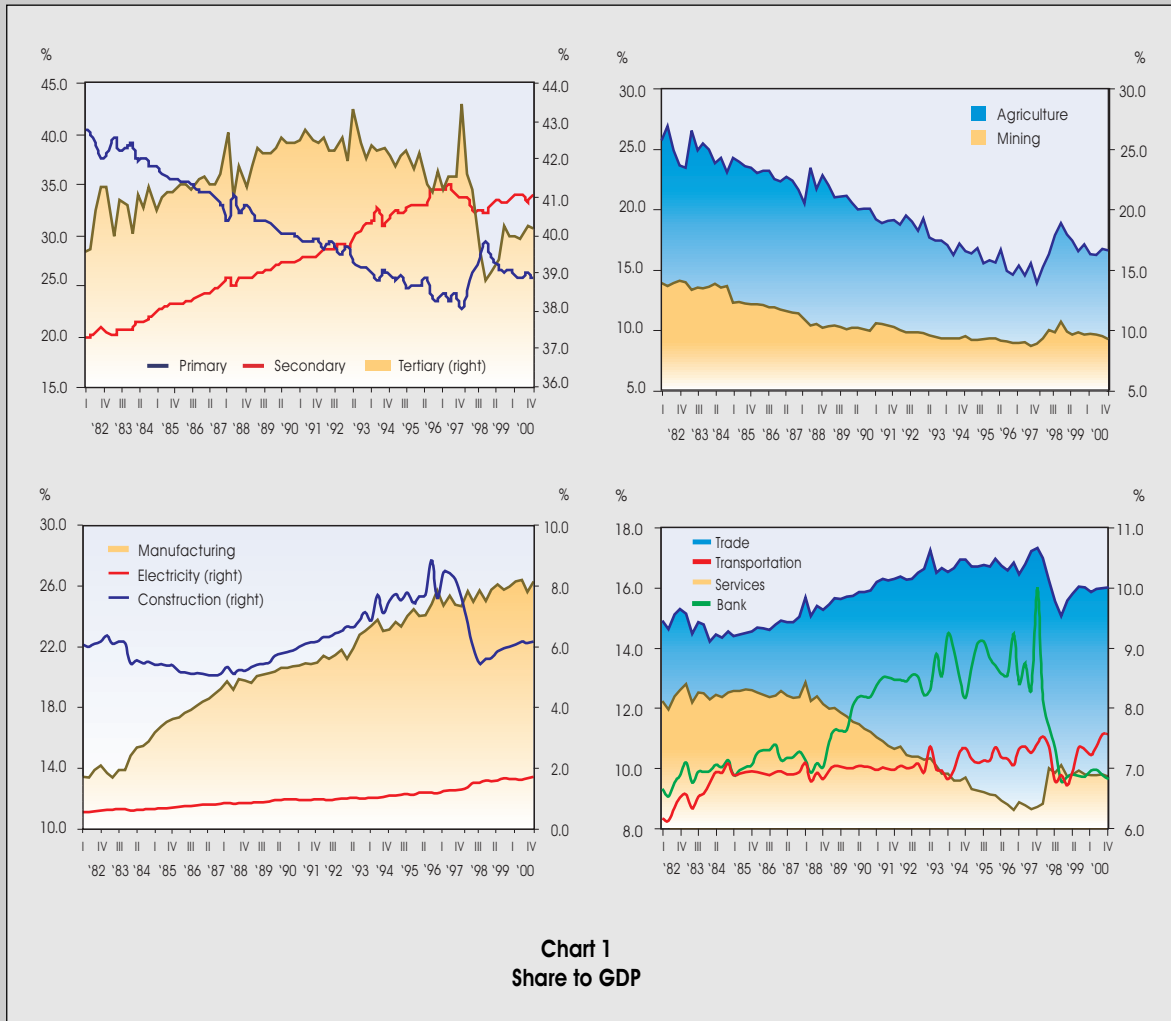

Chart 1
Share to GDP

beverage and tobacco, crude oil and natural gas refinery industries. Still, almost all of the industries in the manufacturing sector fell, especially cement, the automotive industry, machinery and equipment. As in other countries, the correction of the bubbles in Indonesia took place first in the property and construction sector, which fell deeply and reduced its share in GDP drastically. Moreover the share of the tertiary sector experienced the sharpest decline.

These changes in the shares of different sectors in GDP occurred over a period of one to two years. The direction of change has now gradually returned to the pre-crisis pattern of structural transformation typical of developing countries. It is also worth noting that the rise in the share of the primary sector did not represent a dis-transformation phenomenon, but was a mere adjustment due to the drop in the shares of the secondary and the tertiary sectors. Nominally, the added value of the primary sectors did not increase during the crisis, while the added value of the secondary and the tertiary sectors fell drastically. Such a development is not in line with the transformation process, which is characterized not only by a shift in shares but also by a production increase.

Moreover, during the crisis, the disturbance in the production process in the secondary sector, particularly manu-

facturing, were due to the drop in imports following the drastic depreciation of the rupiah since mid-1997. At the same time the rupiah depreciation gave a boost to exports, especially exports of primary commodities. However, as the current account surplus was rising, the capability to import raw materials and capital goods rose, which in turn supported manufacturing activity to meet both domestic and export demand. The recovery of consumer spending and manufacturing marked the beginning of the economic recovery. Growth in the secondary sector was fast outpacing growth in the primary sector, so that the share of these sectors in GDP started to increase.

In conclusion, the crisis, which took place from 1997, did not cause significant changes in the structure of Indonesian economy. The shift in the shares of the economic sectors was only a temporary shock and a correction in the foundation of the economy. The secondary and tertiary sectors will likely continue to become the engine of economic growth, with rising shares. This development teaches us a lesson about the need to formulate an industrial development strategy based on natural resources to enable a more "natural" shift from the traditional primary sector to the secondary and tertiary sectors.



Chapter 3 *Exchange Rate and Inflation*

Exchange rate and inflation developments in 2000 were closely linked with developments in the macroeconomy, domestic politics and security. A faster-than-expected economic recovery was followed by an increase in inflationary pressure, especially from mid-2000. The acceleration of economic activity gave a strong push on the demand side for consumption, imports and investment, but was not matched by an equal rise on the supply side. The supply side was still fragile due to various structural problems stemming from slow progress in debt and corporate restructuring, the failure of the bank intermediation function to recover, and limited foreign financing sources for domestic investment. The investment climate had not improved due to domestic political and security problems. Inflationary pressure arising from these problems and from the climate of uncertainty caused the growth of supply to be unable to support the rise in demand.

Inflationary pressure intensified following the government's decision to reduce subsidies so that price formation would be based on market mechanisms, along with the decision to increase civil servant welfare. The government in 2000 implemented a number of price and incomes adjustments, including reducing fuel subsidies, raising electricity tariffs, transportation fares, and cigarette excise taxes, increasing salaries for civil servants, the military and the police, and raising minimum wages (UMR). Inflationary pressure was also caused by high inflationary expectations on the part of consumers and producers. Expectations of high inflation made the rise in the price level more difficult to curb immediately because inflation developed a persistent character. Headline inflation in 2000 reached 9.35% (year-on-year), up sharply from 2.01% in 1999.

Higher-than-expected rupiah depreciation also added to pressure on the price level through increased import prices. The rupiah exchange rate averaged Rp8,400 per US dollar in 2000, which was weaker than the projected exchange rate of Rp7,000 per US dollar used when calculating the inflation target. Pressure

on the exchange rate increased after April 2000 in reaction to political developments leading up to the annual People's Consultative Assembly (MPR) meeting in August 2000, and as a result of the rise in the value of the dollar against most major currencies as well as robust domestic demand for dollars for repaying foreign loans. The pressure on the rupiah caused the exchange rate to be undervalued relative to its fundamental value.

This development revealed the close relationship between economic, political and security factors, on the one hand, and inflation and the exchange rate on the other. In this situation Bank Indonesia plays an important role in maintaining rupiah stability to support sustainable economic growth. As stipulated in article 7 of the Act Number 23 of 1999 on Bank Indonesia, Bank Indonesia's single objective is to achieve and preserve the stability of the value of the rupiah, both relative to the domestic price of goods and services (inflation) and to foreign currencies (the rupiah exchange rate). To implement monetary control, Bank Indonesia sets an inflation target as the ultimate objective of monetary policy. The inflation target is based on several key assumptions, such as regarding economic growth and the exchange rate, as well as assumptions about the impact of the political situation on the economy. Consequently, the implementation of monetary policy by Bank Indonesia takes into account general economic and financial developments.

Economic, exchange rate and inflation developments in 2000 made the formulation and implementation of Bank Indonesia's monetary policy more difficult and created a dilemma for Bank Indonesia. On one hand, the rising pressure on inflation and the exchange rate required Bank Indonesia to tighten monetary condition. But on the other hand, monetary tightening could not be done drastically and excessively, as it would jeopardize the nascent bank and corporate restructuring. The failure of these programs would hammer public confidence in Indonesia's economic recovery prospects. This could

trigger a depreciation-inflation spiral similar to that experienced at the height of the economic crisis.

To deal with these inflation, exchange rate and economic developments, Bank Indonesia resorted to a tight-bias monetary policy, particularly from May 2000. Under this approach, monetary policy was designed to absorb excess liquidity in the economy so as to reduce pressure on inflation and the exchange rate. In adopting this policy, however, Bank Indonesia avoided any drastic or excessive increase in interest rates.

Monetary tightening measures were implemented through open market operations to mop up excess liquidity so that it would not be used for speculative activity in the foreign exchange market. Monetary tightening was also accomplished by selling dollars to absorb excess rupiah liquidity resulting from the government's development spending funded by revenues. This increased the supply of foreign exchange in the market. Bank Indonesia also took various measures that could directly reduce pressure on the rupiah, such as on spot inspections at certain banks that were key participants in the foreign exchange market, close monitoring of non-resident vostro accounts, and an in-depth study of the possibility of limiting rupiah transactions by non-residents.

Exchange Rate

The rupiah exchange rate in 2000 was on a depreciating trend, with exchange rate volatility on the rise. The average exchange rate for the year was Rp8,400 per US dollar, down from Rp7,850 in 1999. The rupiah fell to a low of Rp9,675 per US dollar at the end of December 2000. With this sharp depreciation, the exchange rate was far from its fundamental value. Pressure for depreciation came mainly from the supply-demand imbalance, excess liquidity in the money market, negative market sentiment regarding the domestic political and security situation, and an increase in rupiah transactions by non-residents.

The supply-demand imbalance was incongruent with Indonesia's stellar export performance in 2000. The relatively large trade surplus during the reporting year failed to increase the dollar supply significantly in the foreign exchange market because not all dollar export revenue was brought into the

country. Also, capital inflows from foreign investment less unreliable, as domestic conditions were not conducive. By contrast, demand for foreign exchange was strong due to genuine demand for private debt repayment. This imbalance yielded thin trading volume, which made the market susceptible to domestic uncertainty. Under these conditions, the exchange rate was volatile, reflecting low public confidence in the rupiah. Continuous social and political conflict in 2000 added to instability and this in turn created asymmetrical market sentiment against the rupiah. With asymmetrical behavior, the market tended to overreact to negative news compared to good news.

Meanwhile, because the bank intermediation function had not yet recovered and investment opportunities in the domestic financial market were limited, there was excess rupiah liquidity in the domestic money market. At the same time, loose regulations concerning rupiah cross-border transactions allowed excess rupiah liquidity in the onshore market to flow to offshore markets easily, which increased the internationalization of the rupiah. Non-residents largely used rupiah for transactions that were not based on real economic activities, including derivative transactions for speculative purposes.

Faced with a continuous downward trend for the exchange rate, Bank Indonesia adopted several measures. **First**, monetary tightening was implemented through open market operations to absorb excess rupiah liquidity in the money market that could be used for speculation. Monetary tightening was also accomplished by selling dollars in the foreign exchange market to absorb government rupiah expenditure while at the same time increasing the supply of foreign exchange on the market. **Second**, Bank Indonesia took steps to directly reduce pressure on the rupiah. These included on-spot monitoring of banks that were the main participants in the foreign exchange market, monitoring of non-resident vostro accounts, and an in-depth study of the possibility of limiting rupiah transactions by non-residents. Nonetheless it must be acknowledged that efforts to reduce exchange rate volatility did not yield optimum results because of the strong influence of non-economic factors.

Exchange Rate Development

The rupiah exchange rate depreciated sharply and was highly volatile in 2000. The rupiah weakened from an average of Rp7,274 per US dollar in January to Rp9,435 per US dollar in December 2000, a depreciation of 22.9%. The rupiah's year low was Rp9,675 per US dollar at the end of December 2000 (Chart 3.1).

The democratic election of a new government in late 1999 initially created optimism regarding the domestic social and political situation and the prospects for economic recovery. This was reflected in positive market sentiment that triggered dollar selling in the currency market and boosted the rupiah exchange rate to nearly Rp7,000 per US dollar. This favorable situation continued until early 2000. The exchange rate was initially projected to be stable at Rp7,000 per US dollar due to expectations of social and political stability in 2000.

Unfortunately these expectations were not fulfilled. The conducive conditions in the early part of the year did not last long as social and political conflict unexpectedly intensified, especially after April. Open conflict among political leaders, ethnic and religious unrest in some regions, and the threat of disintegration once again damaged market sentiment, which encouraged dollar buying. Market confidence in the rupiah deteriorated further after Standard & Poor's cut its long-term and short-term foreign currency sovereign credit ratings for Indonesia from CCC+ and C to SD (Selective Default). At the

same time Standard & Poor's also cut its rating of Indonesia's foreign currency debts to foreign banks from CCC+ to D (default).

Meanwhile, predictions of further rupiah weakening triggered corporate dollar buying in anticipation of debt repayments due in June and July. This added to the pressure on the exchange rate, causing the rupiah to fall through the psychologically important level of Rp 8,000 per US dollar at the end of April, the lowest level since October 15, 1999.

The market's low confidence in the rupiah due to the unfavorable domestic social and political situation persisted in May and continued to weigh on the rupiah. To respond to the depreciation, Bank Indonesia began to implement monetary tightening through open market operations to absorb excess rupiah liquidity. SBI interest rates began to rise to provide a signal to the market regarding Bank Indonesia's tightening measures, which were designed to reduce pressure on the exchange rate. To supplement open market operations, Bank Indonesia sold dollars in the market to boost the dollar supply. However, these measures did not yield optimum results because political conflict escalated. At the same time the US dollar was strengthening against major currencies on market expectations of continued interest rate increases in the U.S. Consequently, pressure on the rupiah continued and the exchange rate fell to a low of Rp8,650 per US dollar in May 2000 (Chart 3.2).

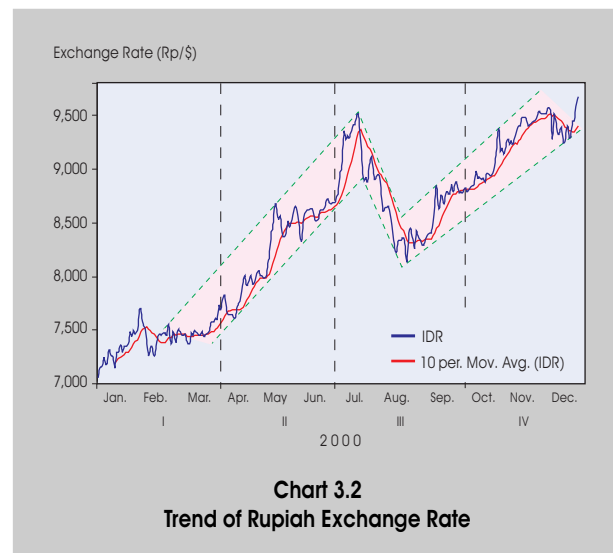
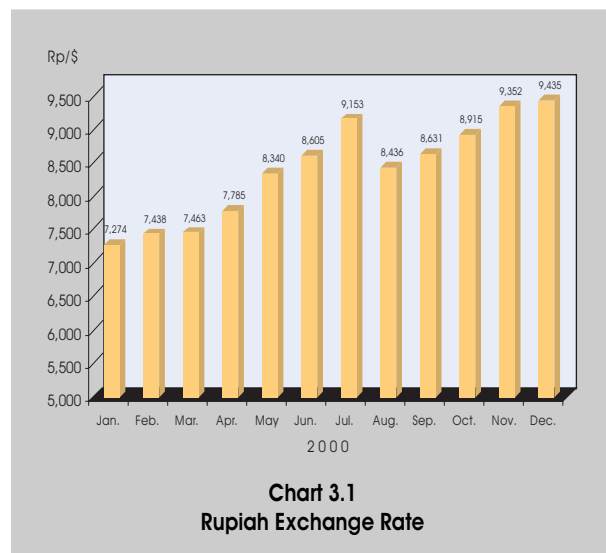

Political conflict continued to escalate in the approach to the annual People’s Consultative Assembly (MPR) meeting in August 2000, raising concerns about domestic security and stability. Uncertainty regarding the social and political situation was reflected in rising swap and risk premiums (Charts 3.3 and 3.4). As a consequence of such developments, rupiah volatility increased sharply and the rupiah exchange rate broke the psychological level of Rp9,000 per US dollar in July 2000 to reach a low of Rp9,600 per US dollar (Chart 3.5).

Concerns receded after the annual People’s Consultative Assembly meeting ran smoothly without major problems. This induced dollar selling in the currency market. Bank Indonesia continued to absorb excess rupiah liquidity through open market operations and dollar selling and increased the dollar supply to the market. Those two factors drove the rupiah higher to nearly Rp8,000 per US dollar in August 2000.

However, the rupiah strengthening did not last long as corporate dollar demand resurfaced for foreign debt repayment coming due in December 2000. Worries over domestic social and political instability increased. Polemics between political leaders, disintegration threats, uncertainty surrounding amendments of the Bank Indonesia Act, and terrorist acts



Chart 3.4
Swap Premium

in certain religious places in some regions once again hammered sentiment in the foreign exchange market.

The deterioration of market sentiment due to unstable non-economic factors, followed by rising corporate dollar demand, caused the market to ignore positive developments such as an upgrade of Indonesia’s sovereign credit rating by Standard & Poor’s and the steady improvement in the economy, supported by exports, consumption and investment. The asymmetrical market response persistently pushed the ru-

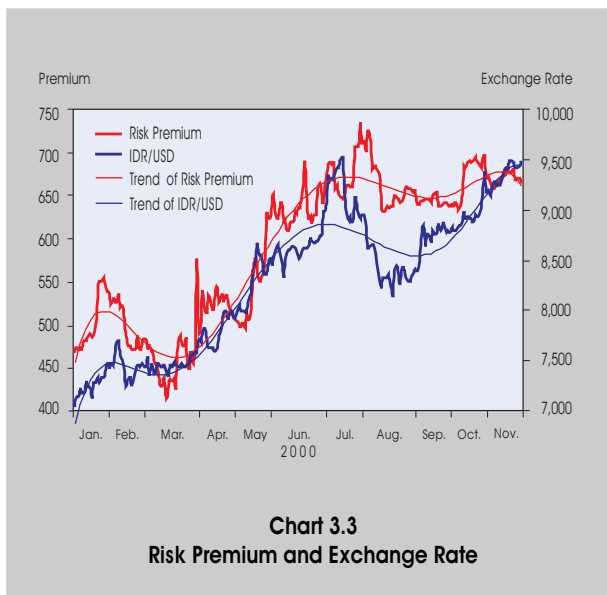

Chart 3.3
Risk Premium and Exchange Rate

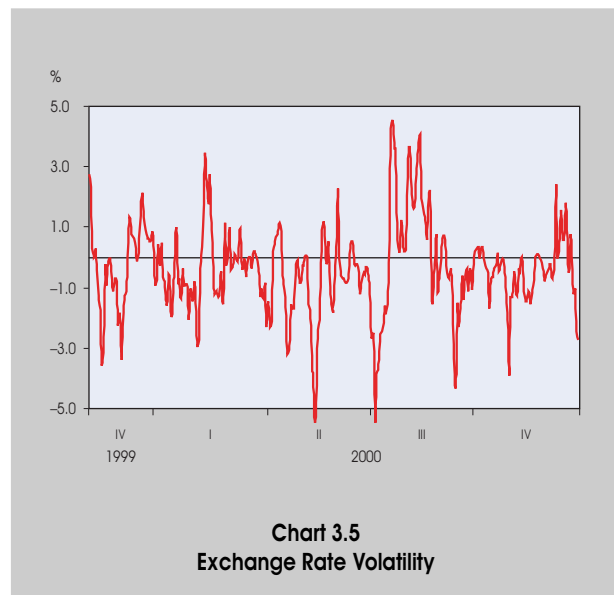

Chart 3.5
Exchange Rate Volatility

piah lower until the end of December 2000. The rupiah's average exchange rate in December was Rp9,435 per US dollar.

The sharp exchange rate depreciation in 2000 caused the market value of the rupiah to deviate significantly from its fundamental economic value. Using a Real Effective Exchange Rate (REER) approach and taking into account the exchange rates of competitor countries, a suitable rupiah exchange rate in 2000 should have been Rp7,500 per US dollar. If this is compared to the average exchange rate of Rp8,400 per US dollar in 2000, the rupiah deviated 12.0% from its fundamental value (Chart 3.6).

The appropriate rupiah exchange rate in December that was in line with internal and external factors was Rp7,600 per US dollar. With an average exchange rate of Rp9,435 in December, the rupiah deviated 24.0% from its fundamental value. Using a Bilateral Real Effective Exchange Rate (BRER) approach, the rupiah was undervalued by 45.0% in 2000 --more than the currencies of Singapore, Thailand, Malaysia, Korea and The People's Republic Of China-- making Indonesia's exports very competitive (Chart 3.7).

The rupiah exchange rate deviation from its economic fundamental equilibrium value can also be explained by the bubble phenomenon in the foreign exchange market (Box: "Speculative Bubbles" in the Foreign Exchange Market).

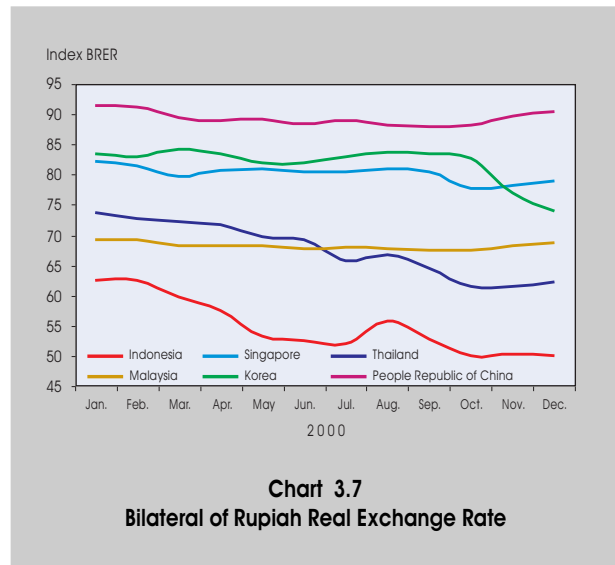
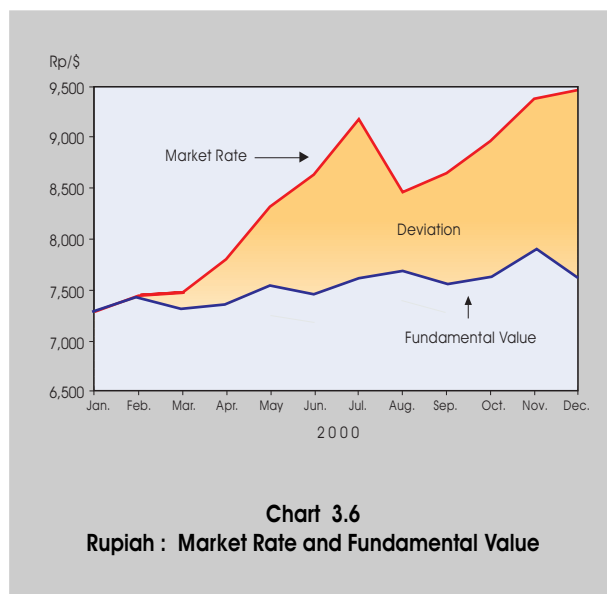

Foreign Exchange Supply

From the supply side, the sources of foreign exchange in the market is export revenue, foreign exchange sold by the central bank, and capital inflows either for foreign direct investment (FDI), portfolio investment, or foreign borrowings. Some obstacles, however, hindered the growth of foreign currency supply, resulting in thin trading volume on the domestic foreign exchange market.

Indonesia's export performance improved in 2000 with a non-oil and gas trade surplus of \$14.9 billion. Private capital flows still recorded a deficit of \$8.5 billion as capital outflows for debt repayment surpassed capital inflows.

The healthy non-oil and gas trade surplus, however, failed to boost the rupiah because not all export revenue was brought into the country. Exporters preferred to park their export revenues in offshore banks for several reasons: **First**, foreign confidence in the stability of Indonesia's social and political situation was very low. Consequently, exporters obtained only short-term trading contracts, and for precautionary reasons they preferred to keep their foreign exchange outside the country. Low international confidence in Indonesian banks also encouraged exporters to open L/Cs with overseas banks. **Second**, by keeping their export revenues abroad, exporters could easily obtain foreign exchange loans for export finan-

cing at low cost, while such loans were difficult to obtain from domestic banks. As a result, most export revenue was kept in escrow accounts in overseas banks. Moreover, exporters' cost in obtaining foreign exchange from domestic banks was considered uncompetitive and inefficient. **Third**, a great deal of Indonesia's export activity came from non-resident exporters and naturally much of this revenue is kept in offshore banks.

Capital inflows, both in the form of FDI and portfolio investment, did not perform well in 2000. Long-term investment could not be counted on due to the low confidence of foreign investors in Indonesia, especially in relation to security problems, the lack of legal certainty, the slow corporate restructuring process, and the high level of exchange rate risk. Moreover, derivative market instruments that could be used by foreign investors to hedge against exchange rate risk were very limited and the derivative market lacked depth.

Short-term portfolio investment, which is very sensitive to expectations regarding the social and political situation, could not serve as a permanent source of foreign exchange supply. Foreign investors in the capital market adopted a hit and run strategy due to the uncondusive social and political situation. Elsewhere in the money market the same situation made foreign investors less sensitive to domestic interest rates. Due to the high level of country risk, the large differential between domestic and offshore interest rates is not the main consideration of investors (Chart 3.8). The shift of funds from European, Japanese and emerging markets to the U.S. also intensified during the reporting year, mainly due to two reasons: **first**, rising U.S. interest rates (profit motive) and **second**, efforts to preserve the value of investment portfolios in light of deteriorating international investor sentiment with respect to emerging markets (flight to quality motive). These two factors indirectly prevented portfolio investments from entering the Indonesian capital market.

Bank Indonesia could supply foreign exchange through its sterilization activity only if necessary. This is because the main function of Bank Indonesia's foreign exchange sterilization activity is to support monetary control by absorbing excess rupiah liquidity to achieve the base money target, and in par-

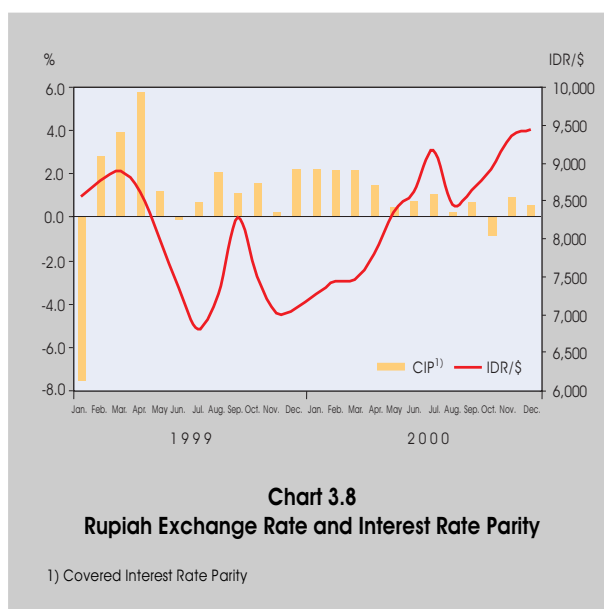

ticular to absorb liquidity resulting from government development spending funded by government foreign exchange revenues.

Foreign Exchange Demand

From the demand side, pressure on the rupiah came from genuine demand for foreign exchange for economic transactions, speculative demand, and portfolio shifting. Genuine demand was mostly for import financing and private debt repayment. Foreign exchange demand for import financing rose in line with an increase in export production. Some state-owned companies also had to buy foreign exchange to finance oil, gas and food imports.

Foreign exchange demand for debt repayment was large and this created strong depreciation pressure on the rupiah, as it was not matched by an adequate supply of foreign exchange (Chart 3.9).

Demand for foreign exchange for speculative purposes and for portfolio-shifting was also robust in 2000 and weighed on the rupiah exchange rate persistently. Strong foreign currency demand for these two motives was related to negative market sentiment due to persistent social and political instability and the slow implementation of the corporate restructuring agenda, which could hamper economic recovery.

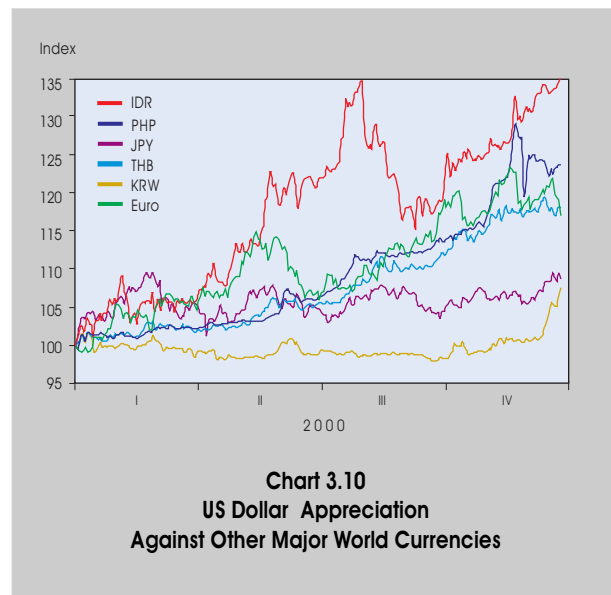
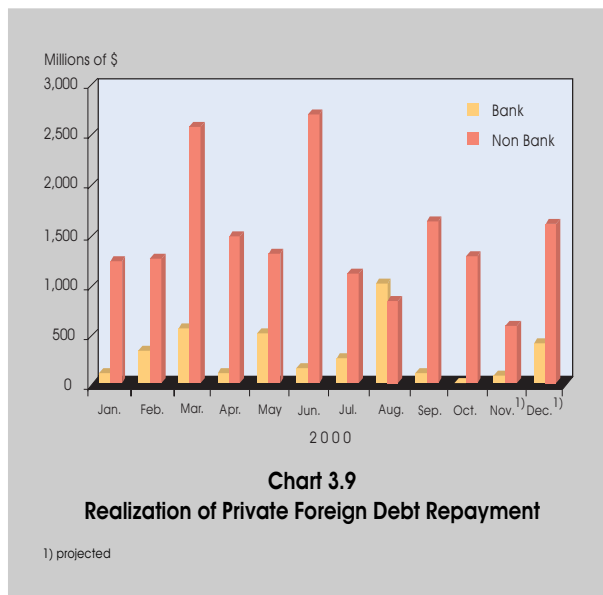

Pressure on the rupiah from the portfolio shifting motive was also triggered by rising regional and global uncertainty. This uncertainty encouraged international investors to shift their portfolio to the US dollar, which is considered as a safe haven currency. Regionally, the country risk of several Asian economies increased mainly due to political instability and slow progress in corporate debt restructuring, which made Asian countries susceptible to external shocks. These factors helped weigh on several Asian currencies.

Meanwhile, the US dollar was rising against major world currencies such as the yen and the euro (Chart 3.10). Appreciation of the dollar was due to faster growth of the US economy than in the European and Japanese economies. Moreover, the US Federal Reserve's tight monetary policy from mid-1999 until mid-2000 widened the interest rate differential between the US and Europe and Japan, which caused an influx of capital into the US.

Rupiah Liquidity and Internationalization

In addition to genuine and speculative demand, the increase in demand for foreign exchange was resulted also by excess rupiah liquidity in the domestic money market. The slow recovery of bank intermediation and the limited number of investment instruments in the domestic money and capital markets

created excess rupiah liquidity in the banking system. Moreover, the regulations that govern cross-border rupiah transactions were very loose. These two factors caused excess rupiah liquidity to flow easily to offshore money markets, especially through interbank transactions.

Most rupiah transactions by non-residents were not based on underlying economic activities, such as exports, imports and investment, but were based on speculative motives. In general, this increased the volatility of the rupiah exchange rate. At the same time, more sophisticated financial engineering raised the intensity of speculation by non-residents, which could not be controlled by Bank Indonesia's prudential regulations (Box : Internationalization of the Rupiah).

Non-residents generally conducted rupiah transactions through several foreign banks acting as market makers and have therefore a significant role in setting prices. Several indicators reflected active participation by non-residents in rupiah transactions. **First**, an increase in rupiah demand by non-residents, as shown by rising rupiah interest rates in offshore interbank money markets, was usually followed by rising pressure against the rupiah. **Second**, vostro accounts (owned by non-residents) were very active, especially for foreign exchange transaction that displayed a persistent ten-

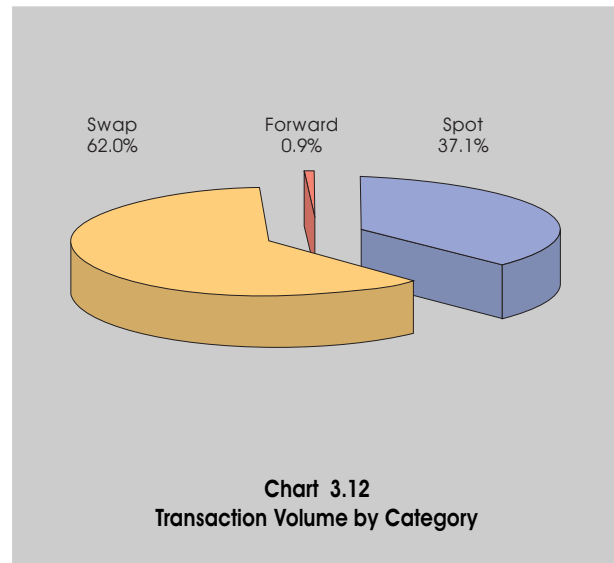
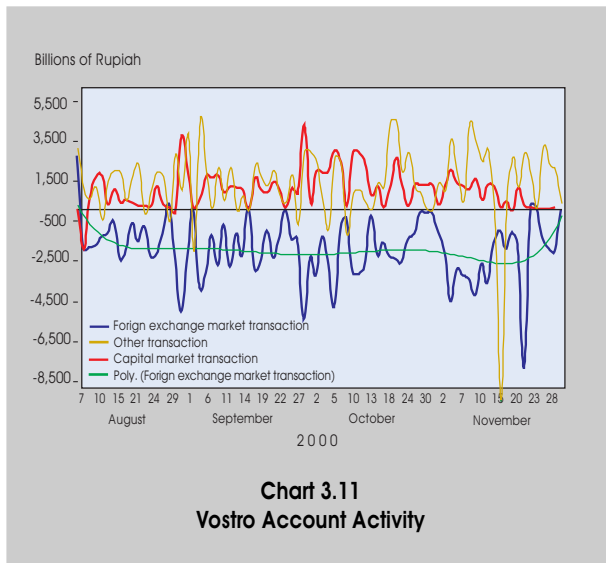

dency toward net outflow (Chart 3.11). **Third**, the share of foreign branch banks in the domestic market was very dominant, consistently exceeding 50.0% of total trading volume in 2000.

Inter-bank Foreign Exchange Transaction

In line with the weakening of the rupiah in 2000, the volume of interbank foreign exchange trading rose 21.6% from the previous year to \$349.0 billion. The average daily trading volume was \$1.4 billion, or up 25.6% from the previous year.

Based on the transaction categories, swap transactions accounted for the biggest share of total volume, followed by spot and forward transactions (Chart 3.12). Compared to the previous year, the share of swap transactions rose 2.5% and that of spot transactions fell 2.5%, while the share of forward trades in total volume was relatively unchanged in 2000. This development indicated that although trading volume increased, market participants were more cautious in anticipating exchange rate fluctuation.

Rupiah interbank spot transactions against the dollar comprised 85.4% of total foreign exchange trading in 2000,¹⁾ with stronger interest in buying dollars than in selling dollars. This was reflected by bank’s spot positions against their counter-

parts, which experienced a net-oversold position of \$135.3 million. Of the total spot transaction value, the spot transactions with domestic customer counterparts experienced an oversold position of \$567.4 million, which means that domestic customers preferred to maintain long dollar positions. On the other hand, banks’ spot transactions with foreign counterparts were overbought of \$432.0 million, which indicated those foreign parties were building short dollar positions.

Based on quarterly developments, bank foreign exchange positions and trading volume fluctuated in line with the rupiah exchange rate. (Chart 3.13). During the first quarter of 2000, average daily trading volume was \$1,080.9 million with a net overbought position. Entering the second quarter of the year, trading volume rose 28.8% with banks in a net oversold position, which reflected rising interest in buying foreign exchange as political tension mounted in the approach to the annual MPR session in August. The rupiah exchange rate weakened sharply during this period. Daily trading volume dropped 5.7% in the third quarter with banks in a net overbought position. This reflected the sale of foreign exchange to banks by the public following active purchasing of foreign exchange during the second quarter and coincided with the appreciation of the rupiah during this period. Daily trading volume fell 3.2% in the fourth quarter with banks in a net condition. This indicated the accumulation of long dollar position amid rising

1) The remaining 14.6% was interbank spot transactions of rupiah against other currencies.

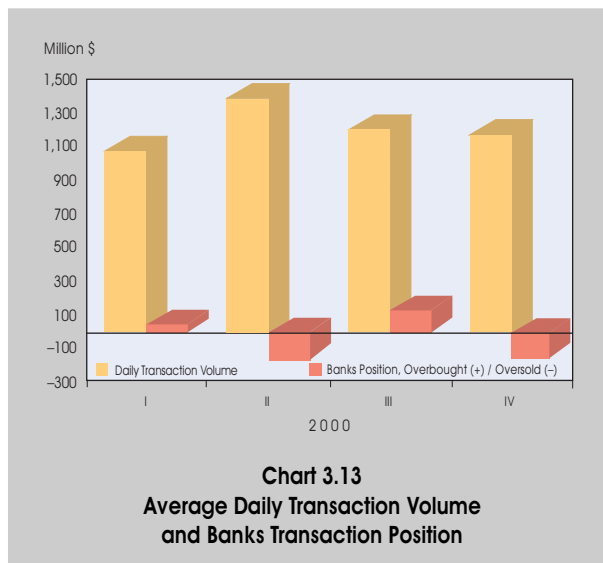

demand for the currency ahead of the year-end. The emergence of some negative news further dampened market sentiment.

Inflation

Inflationary pressure increased in 2000 as economic activity picked up, and in response to the government's price and incomes policy, depreciation of the rupiah, and rising inflationary expectations. These factors caused CPI inflation in 2000 to reach 9.35% (year-on-year), up sharply from 2.01% in 1999. The government's price and incomes policy is calculated to have given contributed 3.19% to inflation in 2000, if measured cumulatively by adding up its respected monthly contribution. Measured year-on-year, the contribution of the government's price and incomes policy to inflation in 2000 came to 3.42%. This was higher than the estimate at the beginning of the year of 2.0%. Excluding the impact of the government's price and incomes policy the inflation rate came to 5.93% in 2000, which was higher than Bank Indonesia's inflation target of 3.0% to 5.0%.

Along with efforts to stabilize the rupiah, Bank Indonesia took various measures to keep inflation within the target set in the beginning of the year. However, Bank Indonesia encountered dilemma in its effort to curb inflation. On one hand, Bank Indonesia wanted to implement a tight monetary policy to achieve the inflation target, with the consequence that the

interest rate would increase sharply, which could block the fragile economic recovery. On the other hand, Bank Indonesia could implement a monetary policy conducive to economic growth but the inflation target would be exceeded. Faced with this situation, Bank Indonesia adopted a tight-bias policy by raising interest rates in stages to provide a signal to the public that Bank Indonesia was consistent in suppressing inflation without significantly disturbing the economic recovery process. This policy was adopted based on the consideration that an aborted economic recovery could reduce the public's confidence in the continuation of the recovery process, which could result in even more inflationary pressure and more pressure on the rupiah.

CPI Inflation Development

CPI inflation reached 9.35% (y-o-y) in 2000, up sharply from 2.01% in 1999. Inflation occurred in ten out of twelve months, with deflation in March and September. The highest month-to-month inflation rate took place in December, when the CPI rose by 1.94%. Pressure on the price level increased during the last three months of the year due to government policies to reduce fuel subsidies, increase cigarette excise taxes, and raise public transportation fares during the Idul Fitri holiday period, as well as rising demand due to religious festivities and New Year holidays (Chart 3.14).

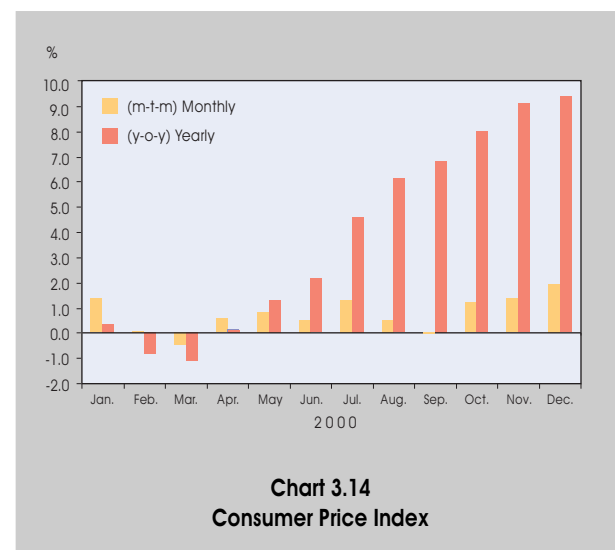

The housing category of the CPI was the biggest contributor to inflation in 2000, with a contribution of 2.66%. Housing costs rose in 1999 and this upward trend intensified in 2000. Inflation in this category was caused by an increase in rental costs, fuel prices, lighting, and water. The processed foods, cigarettes and beverages category, and the transportation and communication category, also contributed to inflation in 2000, with contributions amounting to 1.78% and 1.50% respectively. Categories that contributed less than 1.0% to inflation included food (0.95%), clothing (0.78%), education, recreation and sports (0.80) and health (0.86%) (Chart 3.15).

The inflation rate for food and energy inflation reached 7.95% (y-o-y) in 2000 and contributed 3.84% to total inflation. This was a sharp change from the previous year when food and energy experienced deflation of 1.58% (y-o-y) and contributed minus 0.72% to overall inflation in that year. Food and energy inflation in 2000 reflected a series of government price and incomes policies as well as rising demand, particularly toward the end of the year with the conjunction of several religious holidays. (Chart 3.16).

Factors Causing Inflation

Strong inflationary pressure in 2000 was caused by the acceleration of economic activity, which could not be matched by an increase in supply due to lingering structural problems. In-

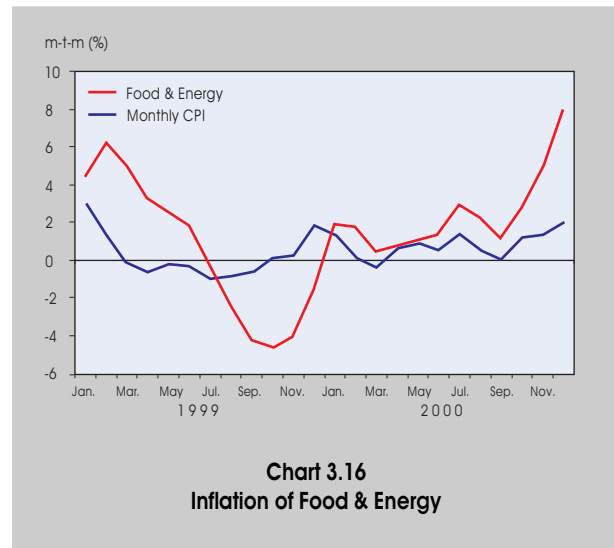
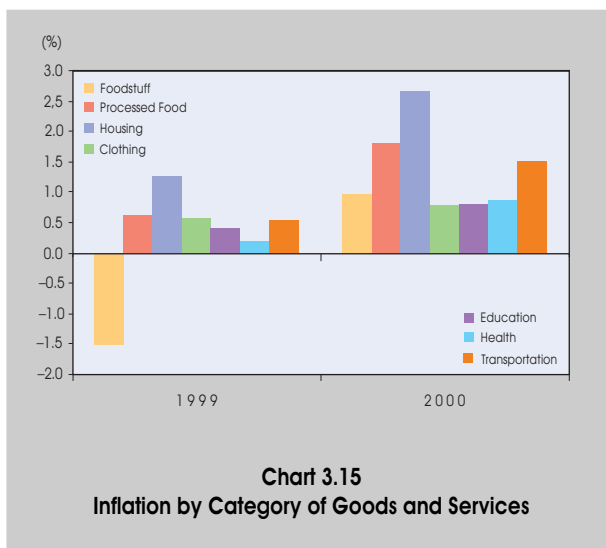

flationary pressure also stemmed from the government’s price and incomes policy, weakening of the exchange rate, and strong inflationary expectations that were already evident from the beginning of the year. Monetary policy to curb inflation faced a dilemma because of concerns that it would hinder the fragile economic recovery process.

Impact of Accelerating Economic Activity

Inflationary pressure was mainly caused by strong aggregate demand in line with an upturn in domestic economic activities. The rise in demand was not matched by rising supply in the short run due to lingering structural economic problems, such as disruption to the bank intermediation function and the low level of investor interest caused by the high level of risk.

The strong inflationary pressure was reflected in the narrowing output gap as shown by an increase in the capacity utilization rate (Chart 3.17). Potential output did not rise significantly because the investment climate was not conducive and because financing sources for expansion were limited, particularly from the banking system.

Some manufacturing sub-sectors that experienced high capacity utilization rates were export-oriented, such as non-ferrous metals, textiles, garments and leather, chemicals, petroleum, rubber and plastic. Capacity utilization in the food, tobacco, and beverage sub-sector remained low.

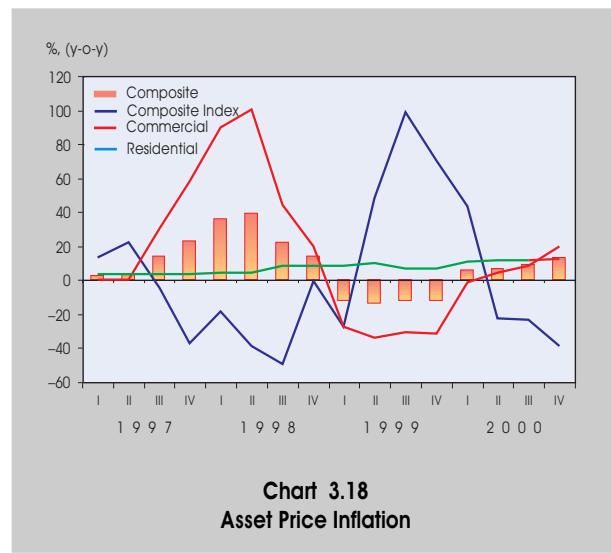
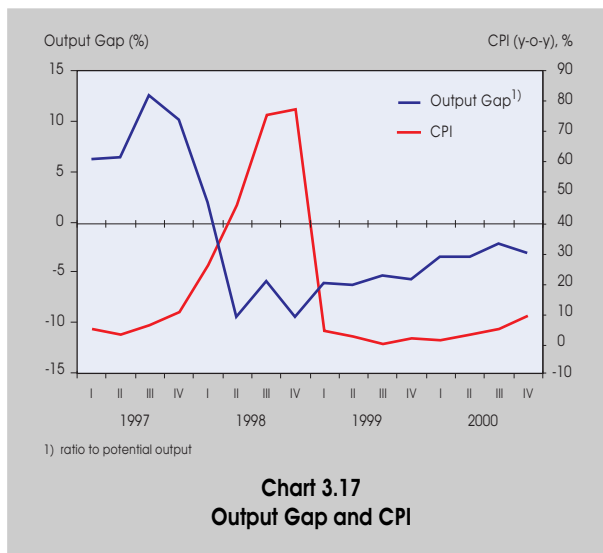

Another indicator pointing to strong inflationary pressure from rapid economic recovery was asset price inflation. Asset price inflation reached 13.0% (y-o-y). The inflation in asset price was mainly due to an increase in property prices. Public interest in property as an alternative store of wealth rose again in 2000. The highest inflation rate in the property sector took place in commercial property, with prices rising by 19.9% year-on-year after falling in the previous year. Residential property assets also recorded high inflation, at 12.2% (y-o-y). Inflation for these asset was driven by an increase in the price of housing materials and a limited property supply amid rising demand. At the same time equity asset, which recorded positive growth in the previous year, witnessed deflation of 38.49% (y-o-y) during 2000 (Chart 3.18). This was mainly due to weak sentiment in regional capital markets and negative market sentiment caused by domestic political instability (Box : Asset price Inflation).

Impact of the Government's Price and Incomes Policy

The government in 2000 issued various regulations concerning price and incomes adjustments, including raising fuel prices, transportation tariffs, electricity tariffs, cigarette excise tax, and import taxes. Incomes policy included an increase in civil servant, military and police salaries, and increases in regional minimum wages. Some of these policies had been disclosed dur-

ing the drafting of the 2000 state budget so that the impact on inflation could be predicted. However, other policies were unexpected and were not taken into account when the inflation target was set at the beginning of the year. Moreover, implementation of these policies followed a different pattern from those in previous years.

The impact of the government's price and incomes policy on CPI inflation included both direct and indirect effects, and an announcement effect. The direct effect was calculated by excluding the contribution to inflation of items in the CPI basket that experienced an increase in price. The indirect effect was calculated by excluding part of the contribution to inflation of items in sub-categories that have a direct connection with items that experienced an increase in price, such as the cost of housing sub-category and the personal effects sub-category. The calculation of the indirect effect made use of information concerning the impact of higher fuel and electricity prices on industries that produce related items, as observed in 1996. The announcement effect of the government's price and incomes policy was calculated by multiplying the actual percentage increase in salaries and in regional minimum wages by the elasticity of inflation with respect to such increases.

Using these methods, the impact of the government's price and incomes policy on monthly cumulative CPI inflation

was estimated at 3.19%.²⁾ This impact was greater than the initial estimate of around 2%. The monthly cumulative direct impact of price policies on inflation was 1.15%, with 0.59% from fuel price increases, 0.43% from cigarette excise tax increases, 0.26% from increases in public transportation prices and 0.23% from higher electricity tariffs. The indirect impact of the government's price policy in 2000 came to 0.84%, with the biggest impact occurring in May (0.25%) and October (0.29%) as a result of increases in public transportation, fuel and electricity prices. The announcement effect, most of which occurred when the government announced the first increase in civil servant, military, and police salaries and in regional minimum wages in April 2000, came to 0.83%. The two increases in civil servant, military and police salaries in April and October 2000 contributed 0.54% to annual cumulative inflation (Table 3.1).

The greater-than-expected impact on inflation of the government's price and incomes policy was due to several factors.

First, some of the price increases had not been planned when the inflation target was originally calculated, so the impact of these changes could not be factored into the initial target. This included the increase in the cigarette excise tax. Although the implementation of the tax increase was delayed from April to November 2000, it had a significant impact on inflation. In addition, the price of cooking gas (LPG) was increased in September, as were postal tariffs.

Second, the magnitude of the increase was not always the same as had been assumed in the initial estimate. Minimum wages, for example, were initially expected to rise by 25.0% but in fact they were raised by between 15.0% and 55.0%. Civil servant, military and police salaries were expected to rise by 30% but the actual increase was greater because in addition to an increase in base salaries there was an increase in structural allowances and in salaries for teachers.

Third, the implementation pattern of price increases was different from that in previous years. For example, the delay in

the fuel price increase, except for the prices of Premix and Super TT, from April to October was not anticipated when the inflation target was calculated. Even though the fuel price increase was delayed, it had already caused an increase in the price of goods in April 2000. Public transportation fares were not increased simultaneously for all types of transportation. An increase in intra-city transportation fares took place in May, particularly in Jakarta, prior to the increase in inter-city land transportation, train and ship fares in September 2000. In general, the increase in public transportation fares preceded the increase in fuel prices. These patterns were different from the pattern of price increase implemented in previous years when all public transportation fares were increased in conjunction with fuel price increases. With the pattern in previous years, the increase in transportation fares could be treated as an indirect consequence of the fuel price increase and the resulting impact on other prices was therefore smaller. The different pattern of adjustment in 2000 caused the increase in transportation fares and fuel prices to have a greater impact on other prices.

Impact of Rupiah Depreciation

Another important factor behind the strong inflationary pressure during the reporting year was the rupiah exchange rate. The average rupiah exchange rate in 2000 was Rp8,400 per US dollar, higher than the initial assumption of Rp7,000 per US dollar.

The impact of rupiah depreciation on inflation was reflected in the inflation rate for traded goods, which was on a rising trend from the second quarter of 2000. The year-on-year inflation rate for traded goods in the Consumer Price Index reached 7.43% in 2000. In the Wholesale Price Index (WPI) the highest inflation rate was recorded in the export sector, with year-on-year inflation for export prices in the WPI reaching 34.49% (Chart 3.19). These developments were in line with the weakening of the rupiah that occurred from the second quarter of 2000. This was confirmed by the results of research on traded goods. The impact of rupiah depreciation on inflation in 1998 was large, with inflation for traded goods reaching 95.24% in that year. In 1999, when the rupiah appreciated, the average price of traded goods in the CPI actually fell by 0.56%.

2) The impact of the government policies on year-on-year CPI inflation in December 2000 was around 3.42%.

Table 3.1
The Impact of Government Policy on Price and Incomes

	Jan.	Feb.	Mar.	Apr.	May	Jun.	Jul.	Aug.	Sep.	Oct.	Nov.	Dec.	Total
	percent												
Direct Impact				0.36	0.32				0.09	0.38	0.36		1.51
Oil and Gas Price				0.08						0.38	0.13		0.59
Transportation Tariff					0.17				0.09				0.26
Electricity Tariff					0.20						0.03		0.23
Cigarette Excise Tax				0.27	-0.04						0.20		0.43
Indirect Impact				0.16	0.25					0.29	0.15		0.84
Announcement Effect				0.56						0.27			0.83
Civil servant salary				0.27						0.27			0.54
Minimum wage				0.29									0.29
Total direct impact (monthly cumulative)				1.07	0.57				0.09	0.94	0.51		3.19
Total policy impact (year on year)													3.42

indicating that the appreciation of the exchange rate was one of the major reasons for low inflation in 1999. The development of the traded goods index shows the importance of exchange rate stability in controlling inflation in Indonesia (Box: The Impact of Exchange Rate on Inflation).

Impact of Inflationary Expectation

Inflationary expectations rose in 2000, as reflected in the results of the Consumer Expectation Survey (SEK) and the Business

Activity Survey (SKDU). These surveys show consumer expectations regarding price developments and producer expectations regarding the development of selling prices, rental costs, interest rates and tariffs. The main factors causing high inflationary expectations were the government's price policy (electricity costs and subsidy reductions), security, social and political instability, and rupiah depreciation. These factors had a psychological impact on consumer demand and on producer price setting behavior (Chart 3.20).

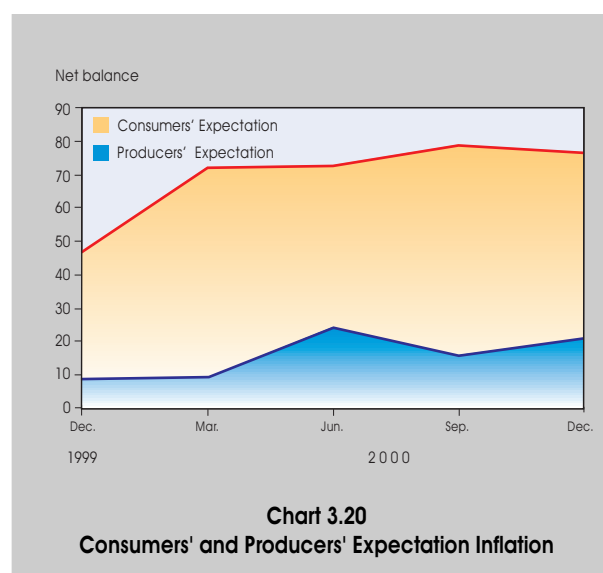
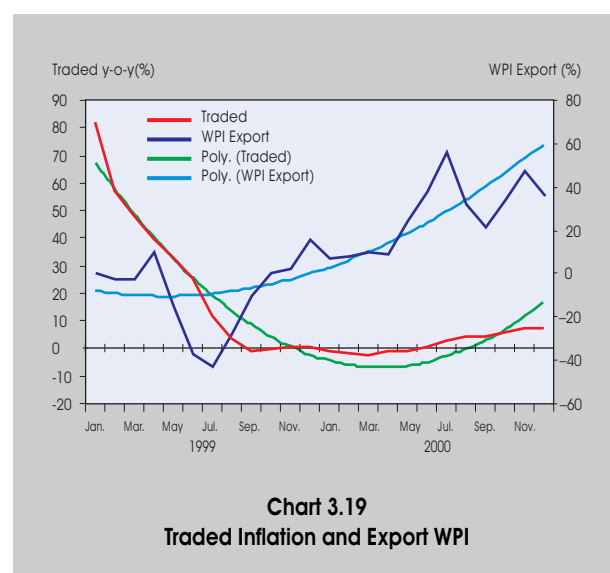

Problem of Controlling Inflation

At the beginning of 2000, Bank Indonesia set a target for inflation that could be influenced by fundamental economic conditions and by monetary policy of between 3.0%–5.0%. This target did not include the inflationary impact of the government's price and incomes policy. Bank Indonesia expected the government's price and incomes policy to add another 2.0% to annual inflation, over and above the 3.0% to 5.0% target.

Bank Indonesia's inflation target for 2000 was established by taking into account overall economic and monetary prospects that could be predicted based on data and information available at the beginning of the year. The optimistic outlook at that time influenced some assumptions used to set the inflation target for the year. Indonesia's economic growth was expected to reach 3.0% to 4.0%, the current account surplus was expected to reach 2.3% of GDP, the state budget deficit was expected to amount to 4.8% of GDP, and global economic growth was expected to reach 3.4%. The rupiah exchange rate was expected to average RP7,000 per US dollar in 2000, on the assumption that the political situation would be stable following the democratic election of a new government in 1999.

Inflation in 2000 exceeded the target set by Bank Indonesia at the beginning of the year. Measured year-on-year, total inflation came to 9.35%. However, 3.42% of this annual inflation was due to the government's price and incomes policy. If this 3.42% is excluded, the annual inflation rate came to 5.93%, exceeding Bank Indonesia's inflation target for 2000 of 3.0%–5.0% (y-o-y). (Chart 3.21)

Some of the problems Bank Indonesia confronted in attempting to achieve the inflation target in 2000 are as follows. **First**, some assumptions used to calculate the inflation target were different from actual developments during the year, such as economic growth, which grew more rapidly than expected. **Second**, the exchange rate did not appreciate to the expected level, but instead weakened further, due mainly to non-economic factors. **Third**, rising inflationary pressure pushed up consumer and producer expectations of inflation, which in turn created additional inflationary pressure (the phenomena of

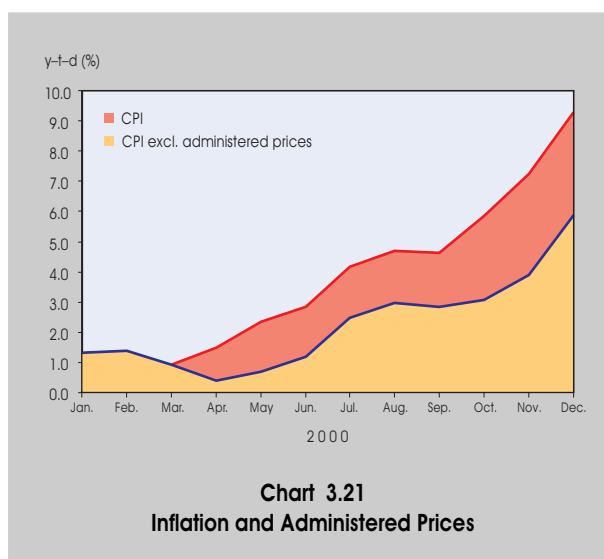

self-fulfilling inflationary expectations). **Fourth**, the economic recovery was still fragile, with short-term supply bottlenecks preventing output from meeting demand.

Under these circumstances, and taking into account the fragile nature of the economic recovery, the implementation of policies to achieve the inflation target had to be done cautiously. Bank Indonesia took various measures to achieve the inflation target. However, Bank Indonesia encountered several problems during the implementation of these policies, especially the dilemma between economic recovery and controlling inflation, as explained above. Moreover, Bank Indonesia's monetary tightening signal, which involved raising the benchmark SBI rate to curb inflation, did not result in corresponding adjustments by banks because the bank intermediation function had not been fully restored. The ongoing bank restructuring process, the fragile condition of the economic recovery process, and the underdeveloped domestic bond market, directly and indirectly limited Bank Indonesia's room to implement monetary policy to achieve the inflation target. Given these conditions, drastic and excessive monetary tightening to achieve the inflation target would have increased the risks against the continuation of the recovery of the banking system and the economy, which in turn could imperil rupiah stabilization and the inflation target itself.

Box : Asset Price Inflation

The dramatic development of the business cycle at the end of the 1980s created difficulties for the monetary authorities of several industrialized nations in identifying inflationary pressure. This was because inflationary pressure can arise not only from the goods market but also from the asset market. Conventional monetary policy, which only considers indicators that measure prices of goods and services such as the consumer price index, proved to be slow in anticipating rising inflation. This was because inflation calculated from the items in the CPI basket does not take into account price increases in asset markets. Price changes in asset markets are not directly reflected in the CPI. Experience in several countries showed that although the CPI did not rise significantly, price pressure in the property market was quite strong, as seen from price increases for land, houses, office rents, and stocks. Interest in asset price inflation has been strong since the emergence of the bubble phenomenon¹⁾ in several countries, such as the U.S., Europe, and Japan.

To calculate asset price inflation, an asset price index, which is a composite index of several types of assets, must first be formed. Theoretically, assets to be included in the asset price index include all types of asset widely owned by the public. The type of assets excluded in general are: rural assets, household durable goods, notes and coins in circulation, net assets held abroad and non-financial holdings of government fixed income securities. In several countries, the asset group is excluded from the calculation because of its relatively small portion to total public wealth, high supply elasticity, and low price volatility.

In general, the type of assets included in the calculation of the asset price index includes: equity assets, commercial property asset, and residential property asset. Equity assets are a group of asset reflecting company values. Since the wealth of companies is difficult to calculate exactly, equity assets are often measured by the stock price composite index. Commercial property is property owned for the purpose of investment (except housing and apartments) or production activity such as

office space, malls, retail outlets, industrial zones, warehouses and recreation facilities. Residential property is property used for housing or dwelling places, for example real estate, apartments or land planned for housing or dwelling places.

In calculating asset price inflation, the weights applied to each type of asset in the composite index are very important. The weighting is calculated based on the share of the three types of asset in the public asset portfolio. In countries that already have Standardized National Accounts (SNA) data, it is easier to decide the share of each type of asset. The weighting for one country can be different from others in accordance with the economic characteristic of one particular country.

In general, the asset price index can be calculated using the following formula :

$$AP(t) = \sum_{i=1}^n w(i,s) p(i,t)$$

AP(t) = Price asset index at certain time

w(i,s) = Weight for asset (i) which is equity, commercial properties and residential properties for certain time validity

p(i,t) = Asset Price Index (i) at (t) time

Experience from several countries demonstrates that asset inflation is triggered by regime switching, deregulation of banking and the financial sector, modification of state finances and the tax system, and a change in the exchange rate system that has a structural impact on the economy. The process of asset inflation can be depicted in a simple diagram as follows :

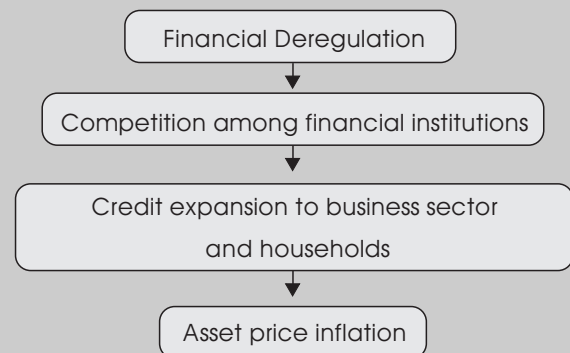

1) A bubble can be defined as the deviation of an asset price from its fundamental value.

Deregulation of the financial sector is aimed at reducing government intervention and letting market mechanisms work. Market forces increase competition among financial institutions in the provision of services to customers, as can be seen by the emergence of new financial institutions, financial product innovation, and the increase in the supply of credit by banks. This makes public access to financing and to financial markets easier and cheaper. This will, in turn, accelerate bank credit expansion and stimulate growth of currency in circulation. Meanwhile, tax deregulation provides opportunities to the private sector to accumulate debt and reduce the equity component of its business structure. The debt is mostly used to finance merger and acquisition activities as well as developing new real estate projects.

Excess liquidity following banking and financial sector deregulation provides incentives to the public to alter its consumption pattern toward additional spending which is mostly financed by credit, including luxury goods, houses, and other durable items. With a significant increase in the consumer spending for the repayment of interest on loans, the consumption pattern of the public becomes more sensitive to interest rate changes. In addition, excess liquidity causes asset values to appreciate, providing large capital for asset owners, particularly owners of housing and commercial asset. Profits also grow in the financial asset market. The increasing wealth effect continues to stimulate consumption and strengthens expectations of higher asset prices. This situation continues until the bubble in the asset market bursts and the economy moves towards a new equilibrium.

Box : The Impact of Exchange Rate on Inflation

In standard international economics texts, the exchange rate is believed to be one of the factors affecting inflation. Concern about the exchange rate in Indonesia has been increasing because of the high volatility and sharp depreciation in 2000. At almost the same time that the exchange rate weakened, inflationary pressure started to increase, causing year-on-year inflation to reach 9.35 percent in 2000, up sharply from 2.01 percent in the previous year.

In general, inflation is defined as a process of continuously rising prices as a result of imbalances in the economy. Inflation is caused by both external and internal factors. Internal factors include natural disaster, changes in administered prices, seasonal factors such as religious festivities, and speculative action such as hoarding of goods which can affect the supply of goods. The influence of external factors is reflected in rising international prices, caused either by higher prices in world markets or by exchange rate depreciation.

The transmission mechanism from the exchange rate to inflation includes both a direct effect and an indirect effect (diagram: exchange rate transmission mechanism). The direct effect works through imported goods (imported inflation), including consumption goods, raw materials, and capital goods. The effect of the exchange rate on inflation through imported consumption goods can be considered to be the primary pass through because the import price can directly affect the domestic selling price. The elasticity of demand for consumption goods with respect to exchange rate changes is high. The exchange rate effect through imported raw materials and capital goods is considered the secondary direct pass through, because price changes are transmitted through the domestic production process. The elasticity of demand for raw materials and capital goods with respect to exchange rate changes is lower than that for consumption goods. Currently, raw materials account for about 73% of non-oil imports. This means that the direct pass through from the exchange rate to inflation works mainly through changes in the price of imported raw materials.

The indirect effect is caused by demand-pull factors, with higher international prices or appreciation of foreign cur-

Diagram : Transmission Mechanism on Foreign Exchange in Small Scale Economic Model ¹⁾

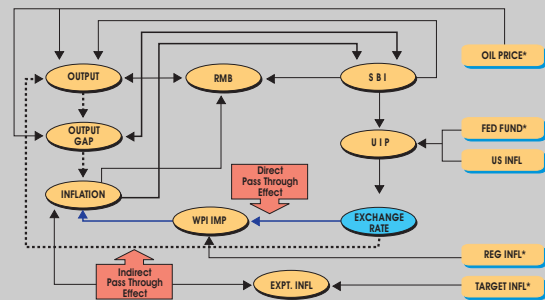

Note :

- * = endogen variable
- Reg.Infl = Regional Country Inflation
- US Infl = US inflation
- RMB = Real Money Balance
- WPI IMP = Whole Price Index Import
- UIP = Uncovered Interest Rate Parity

rencies against the Indonesian rupiah causing higher revenue for local exporters, which in turn triggers higher demand for domestic goods and services. The higher demand increases prices.

In several developed nations, exchange rate depreciation has been found to result in higher demand, as suggested above. In the case of Indonesia, however, research shows that the depreciation of the rupiah caused a decline in demand.²⁾ This is due to the structure of Indonesian industry, both export industries and those that produce for the domestic market, which has a high import content. In addition, the credit structure in Indonesia prior to the 1997 economic crisis, with foreign currency loans accounting for around twenty percent of total credit³⁾, caused the cost of capital for Indonesian industry to be very sensitive to exchange rate developments. This condition caused production costs to increase when there was a

- 1) Dynamic Macro Modelling used for conducting Indonesian Inflation projection
- 2) See Fadjar Majardi, "The impact of fluctuation in the exchange rate of the rupiah on Indonesian inflation," Bank Indonesia, 2000
- 3) The average figure of the ratio of outstanding foreign exchange credit to total credit from March 1993 until June 1997.

depreciation, which in turn lowered income and reduced demand.

In addition to the above transmission mechanisms, inflationary pressure is also influenced by expectations of higher inflation, which can be due to exchange rate changes as well as other factors. Expectations are closely linked to the pattern of behavior of players in the economy according to the information they have. The type of information they obtain can vary (asymmetric information) and different players will react to the same information in different ways. This expectation exists in the goods market, the financial market, and the labor market, with each market linked to the others in affecting price developments.

Based on the inflation model that has been developed, the expectation variable employing adaptive expectations method (backward looking)⁴⁾ has a greater effect on inflation than other expectation variables. Based on previous experience, the weakening of the rupiah exchange rate caused an increase in prices, so if the rupiah were to weaken again, eco-

nomic agents (for example traders) would try to raise the price of their goods to maintain their real income, even if the goods they sell have no direct link to the exchange rate. From the consumer side, depreciation of the exchange rate is anticipated by purchases of goods and services, which increases demand and results in higher prices.

The analysis of expectations becomes more complex if it is linked with market demand for information about the development of economic variables in the future as additional information for making current decisions. Such a situation can be depicted as a market reacting to future events (forward looking expectations). As an example, prices might increase in line with expectations of rising political tension in the future, with higher political tension expected to weaken the rupiah. Public expectations concerning price changes in Indonesia are believed to be formed from a combination of backward and forward looking expectations. That is why the supply of sufficient and accurate information to the public is very important in directing public expectations to the desired goal.

4) Backward looking expectations assume that inflation in the previous period will carry forward to the current period and into the future. Forward looking expectation employs information about the future as a variable that will affect the current period.

Box : Internationalization of the Rupiah

Indonesia gradually liberalized its foreign exchange system starting in 1970 and since 1982 Indonesia has adopted a free foreign exchange system as stipulated in Presidential Decree Number 1 of 1982 and further strengthened by Act Number 24 of 1999 on Foreign Exchange Flows and the Exchange Rate System. The free foreign exchange system was followed by the liberalization of the financial sector, particularly banking, from 1983 to 1988. In line with the liberalization process and accelerated integration of the world financial system, foreign exchange transactions developed very rapidly and capital flows continued to grow, with the private sector playing a more dominant role. Controls on foreign exchange transactions, in the form of capital controls, were avoided on fears that they would reduce investor confidence and inhibit the development of the domestic financial market. This was particularly important because Indonesia was still heavily dependent on the inflow of foreign capital and was in fact a net importer of capital until 1997, with a huge saving-investment gap.

The liberalization process made Indonesia a liberal country in relation to cross border transactions, both in foreign exchange and in local currency, particularly in Southeast Asia. This was reflected in Indonesia's low capital control index compared to other Asian countries (Chart 1). Relatively free cross border transactions promoted an active offshore rupiah market. The rupiah became a commodity tradable in the international market, reflecting a process of internationalization of the rupiah.

Internationalization of the rupiah in general can be defined as the use of the rupiah in international transactions, including trade (export or import of goods and services), investment, and financial market transactions. The international use of the rupiah for export and import payments had not been significant. Export and import invoices were mostly denominated in major world currencies, including the U.S. dollar and Japanese yen. So the internationalization of the rupiah was mostly in relation to the use of the rupiah in the financial market. An indicator of the internationalization process of the rupiah was the huge share of transactions made by non-resi-

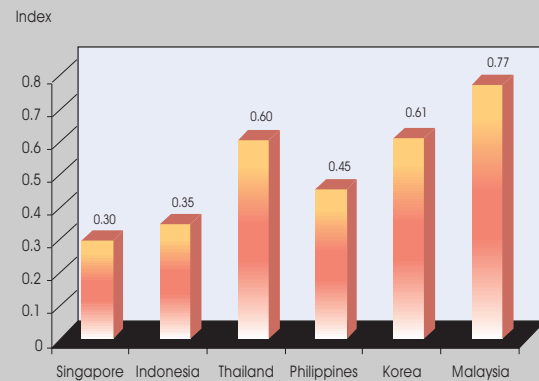

Chart 1
Capital Control Index

dents and international financial institutions in the domestic financial market.

At the beginning of the massive financial sector liberalization, there was a tendency to push for the internationalization of the rupiah. At the time, internationalization of the rupiah was deemed useful to encourage the development of the domestic financial market and to encourage capital inflows from foreign investment. But in later developments, the internationalization of the rupiah provided an opportunity for non-residents to speculate in the offshore rupiah market, supported by rupiah innovation.

Speculative activity in the rupiah intensified amid the lack of stability in Indonesia's social and political situation. This caused excessive exchange rate volatility and made it difficult for monetary policy to maintain the stability of the rupiah, which had a negative impact on the overall macroeconomic situation.

Given this situation, non-residents played a large role in deciding the direction of the exchange rate because their activity was followed by players in the local market (herding behavior). The negative opinion of non-residents regarding domestic social and political stability often had a psychological impact on the domestic market, which then created negative sentiment toward the rupiah. Moreover, foreign banks opera-

ting within Indonesia and used by non-residents for rupiah transactions were big players with a huge influence on the market. Foreign banks controlled more than fifty percent of total derivative transactions in the domestic foreign exchange market.

It is difficult to know the exact amount of offshore rupiah because this is beyond Bank Indonesia's jurisdiction. However, rupiah transactions by non-residents could be traced through their vostro accounts with onshore banks. So the large role of non-residents in affecting the direction of the exchange rate could be seen through the volume of activity in vostro accounts. Based on observation of vostro accounts, it could be seen that activity in these accounts tended to be high and volume increased during periods when the exchange rate were under heavy pressure (Chart 2).

Rupiah speculation by non-residents was made possible because of relatively easy access to rupiah from onshore banks. In addition, liquidity in the financial market tended to be loose since the banking sector had yet to resume its intermediary function, causing more rupiah funds to circulate in the financial market. With alternative investment opportunities still limited, investing in the foreign exchange market was one attractive alternative for banks with excess liquidity.

Because of the above problems, it was deemed necessary to have a policy that could minimize the opportunity for non-residents to speculate against the rupiah, including by limiting their access to rupiah funds. This was particularly important because the use of the rupiah overseas tends not to be related to investment or trade activities that could help stimulate the real sector of the economy. There was an urgent need to implement a policy that could limit rupiah transactions between onshore banks and non-residents. This was

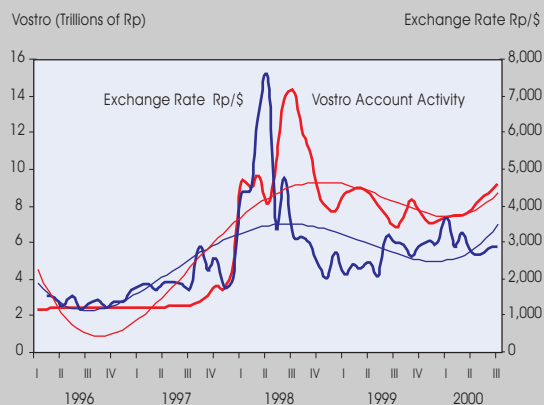

Chart 2
Exchange Rate and Vostro Account Trend

supported by Bank Indonesia research concluding that capital flow policies, which could increase prudential management of the financial system such as limiting the internationalization of the rupiah, could be used to reduce the volatility of the rupiah exchange rate.

The research recommends: (i) expanding the scope of the lending prohibition to non-residents, prohibiting not only cash loans but also transactions those create rupiah claims to non-residents, including the placement of rupiah funds with non-residents, the purchase of rupiah securities issued by non-residents, and the revision of the ruling on derivative transaction limits with no underlying transactions; (ii) limiting the use of vostro accounts. Non-internationalization of the rupiah is needed to cut off the access of non-residents to rupiah funds that could be used for speculative activity, so that the volatility of the exchange rate could be minimized.

Box : “Speculative Bubbles” in the Foreign Exchange Market

Under a floating exchange rate regime, exchange rate volatility can often become excessive and out of line with economic fundamentals. Depreciation can occur even when a nation’s economic situation is improving. This can happen because with a freely floating exchange rate, expectations about the future direction of the exchange rate play a very important role in every decision made by market participants, whether speculators or investors. Exchange rate fluctuations caused by changing expectations are particularly likely to occur when the exchange rate moves in a “speculative bubble” pattern. Such fluctuations are “noise” that cannot be explained by macroeconomic variables.

When moving in a “speculative bubble” pattern, the market-determined exchange rate fluctuates farther from the equilibrium value that is consistent with the nation’s economic fundamentals because of an expectations bubble linked to the process of “self-confirming expectations” in the foreign exchange market. The expectation bubble can be explained as follows. In period 0, for various reasons -- for instance, because of possible political instability in the future -- speculators expect that the rupiah will depreciate in period 1. To protect their portfolio from exchange rate risk or to profit from the expected depreciation, speculators sell the rupiah, which causes its value to weaken. In period 1, the rupiah may actually depreciate, which justifies the expectations of the speculators. This will occur if there is rupiah selling activity in period 1 because of expectations of rupiah depreciation in period 2. Is it unreasonable to have expectations that the rupiah will depreciate in period 2? No, if there is rupiah selling activity as a consequence of expectations that the rupiah will depreciate in period 3. It will also be rational for speculators to expect depreciation in period 3 if depreciation is expected to occur in period 4, and so forth. Without any known specific period when the process of the bubbling of expectations will stop, the value of the rupiah will continue to move away from its equilibrium value as determined by economic fundamentals. In general, speculators tend to follow “herding” behavior, because with a majority of the speculators in the market trying to

put pressure on the rupiah in an upward direction, a speculator will lose if he or she tries to move against the market trend.

In practice, the exchange rate determined in the market will not continue to move away from the equilibrium determined by economic fundamentals for an infinite period of time. The most frequent situation is for the exchange rate to move away from the fundamental equilibrium exchange rate for a short period prior to the bursting of the speculative bubble. But it is quite possible for speculative bubbles to form and to burst over and over again, which increases the volatility of the exchange rate. Economists who strongly believe that it is important for the monetary authority to recognize this phenomenon believe that market intervention by the central bank in the foreign exchange market can reduce unnecessary volatility in an economy even if there is no change in monetary policy.¹⁾

With a freely floating exchange rate, market players can freely buy or sell a currency based on their expectations concerning the future direction of the exchange rate in order to earn a profit. If speculators act on the basis of their expectations about the direction of the exchange rate, then to gain profit they will buy a currency when the exchange rate is high and sell when the exchange rate is low (buy low, sell high). Will this kind of speculation increase the volatility of the exchange rate? Not necessarily, because increased purchasing will cause an exchange rate to strengthen and increased selling will cause it to weaken. This kind of speculation causes supply and demand pressure that eventually converges to a point of relative stability.

In reality, speculators do not behave in this way. Speculators in general form their expectations by extrapolating past trends, often described as “the expectation bandwagon”. If speculators act in this way they will jump on the bandwagon when the exchange rate starts to move up or down. With this

1) John Williamson and Marcus Miller, *Targets and Indicators : A Blueprint for the International Coordination of Economic Policy*, Policy Analyses in International Economic, No. 22 (Washington : Institute for International Economics, September 1987)

behavior they can create a speculative bubble as described above. Speculators adopt a "buy high sell low" strategy in which they sell a currency when the exchange rate is weakening, thereby increasing pressure on the currency and causing additional depreciation (until the expectations bubble bursts). Speculators will also buy a particular currency when the exchange rate is strengthening, causing additional appreciation. This kind of speculation basically causes the currency to become extremely unstable and creates a volatile foreign exchange market.

If market mechanisms function properly and if expectations are based on economic fundamentals, a number of economists believe that expectations will play a big role in stabilizing the exchange rate. For instance, if the domestic currency overshoots its equilibrium value, as determined by purchasing power parity, due to an increase in the money supply, speculators or investors will expect the currency to appreciate again. How such expectations are formed can be explained with Dornbusch's model, as illustrated in Chart 1.

Assuming that prices do not change much in the short run (prices are sticky) a 10 percent increase in currency in circulation will cause real currency in circulation to grow by 10 percent. The adjustment mechanism in the money market will lead interest rates to go down, which in turn will trigger a capital outflow causing the domestic currency to depreciate. The equilibrium exchange rate, S , will also depreciate by 10 percent. In reality, however, it is possible for the exchange rate in

the market to overshoot, depreciating by more than 10 percent to reach s .

In the long run, prices are flexible. When the economy is in short term equilibrium at C , the exchange rate is very weak (competitive) which stimulates demand for domestic products. The real interest rate at C is also very low and this stimulates investment and consumption. These two factors create pressure on prices, which in turn causes the real quantity of currency in circulation to decline. Consequently interest rates gradually increase, encouraging capital inflows and causing the exchange rate to appreciate back to the equilibrium value based on purchasing power parity, moving the economy to B . Speculators or investors behaving on the basis of these expectations will purchase domestic currency, causing the exchange rate to strengthen again.²⁾

However, it is very hard to accept the reality that expectations developed in the market are based on the results of speculators understanding the economic phenomenon explained above. Often market players (in general) disregard the development of economic fundamentals and focus more on extrapolating trends. By using technical analysis³⁾ speculators, who are often called "noise traders," can cause exchange rates to deviate greatly from the equilibrium value based on fundamentals, with no expectation that the exchange rate must return to the previous fundamental equilibrium as asserted in the overshooting approach discussed above. In the last decade, the number of speculators in the world foreign exchange market acting as "noise traders"⁴⁾ has been relatively larger than investors acting on the basis of fundamentals. This explains why the expectations bandwagon approach provides a better explanation of exchange rate movements and why exchange rate changes basically cannot be fully explained using the economic fundamentals approach.

The "expectations bandwagon" phenomenon as explained above has occurred in the rupiah market, particularly

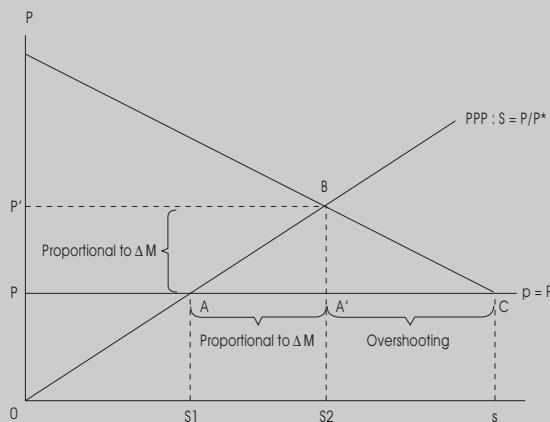

Chart 1
Dornbusch Overshooting Model

- 2) Richard E. Caves, Jeffrey A. Frankel, and Ronald W. Jones, *World Trade and Payments* (1996)
- 3) Technical analysis is study about price trend movement with its philosophy is "history repeat its'self, price move in trend, and price discount everything"
- 4) Noise traders are their speculators who sell and buy currency or asset based on their beliefs which is not entirely consistent with economic fundamental

after Indonesia adopted a freely floating exchange rate system, under which technical analysis as a tool to make exchange rate forecasts has been used in rupiah trading. The use of technical analysis became more intense in line with the increase in the internationalization of the rupiah. Speculators in off-shore and on-shore markets use trend analysis by observing asymmetric sentiment arising as a result of instability in the domestic social and political situation. This caused the trend for the rupiah exchange rate to rise persistently throughout the year 2000. When the exchange rate crossed psychological levels such as Rp8,000 and Rp9,000 this further prompted speculators to sell the rupiah (jump on the bandwagon) with the hope that the exchange rate trend would continue to move upward (self-confirming expectations).

The reality described above can explain why the exchange rate of the rupiah depreciated sharply and why it is difficult for the exchange rate to return to its fundamental equilibrium level. In addition, although the exchange rate of the rupiah has depreciated significantly and contributed to a trade surplus, the automatic adjustment process that should result from this surplus has not worked, and has therefore not helped the rupiah appreciate. The adjustment process had not worked because not all export revenue has been repatriated. On the other hand, persistent social and political instability in 2000 created negative sentiment toward the rupiah, providing further room for the development of a speculative bubble process, which basically cannot be explained using the economic fundamentals approach.

Chapter 4 *Monetary Development*



At the beginning of the year 2000 Bank Indonesia established a target for the annual growth rate of base money of 8.3%. This target was established on the basis of relatively optimistic expectations about Indonesia's economic performance. It was assumed, for example, that GDP growth would reach 3.0% to 4.0% in 2000, that the exchange rate would average Rp7,000 per U.S. dollar during the year, and that the inflation target of 3.0% to 5.0% (excluding the impact of the government's price and income policy) would be achieved.

During the course of the year, the effort to attain this growth target for base money faced many difficulties. Economic activity grew more strongly than had been anticipated, inflationary expectations intensified, and the exchange rate came under strong pressure. Adding to these difficulties was rising uncertainty created by the domestic social and political situation and the fact that the intermediation function of banking system had not yet recovered. All of these problems limited the effectiveness of Bank Indonesia's monetary policy.

Higher economic growth, rising inflationary expectations and a weakening exchange rate, resulted in a surge in demand for base money. Because the intermediation function of the banking system had not yet returned to normal, the banking system did not respond in proportion to Bank Indonesia's monetary policy signals, making it difficult to absorb currency in circulation. Currency is the largest component of base money. Increase in the public holding of currency as a precautionary measure in the face of rising social and political uncertainty also made monetary control difficult.

Bank Indonesia therefore faced a dilemma in executing monetary policy. Efforts to curb demand for base money required a tighter monetary policy, which would cause interest rates to rise. However, because the monetary policy transmission mechanism was not functioning properly, a tighter monetary policy could result in a drastic rise in interest rates that would be unfavorable for the ongoing economic recovery.

Faced with this problem, Bank Indonesia adopted a tight bias monetary policy that was aimed at absorbing excess liquidity beyond the amount needed for real economic activity, while maintaining a conducive climate for economic recovery. Accordingly, this tight bias monetary policy was carried out while avoiding any abrupt or excessive increase in interest rates.

To control base money, Bank Indonesia conducted open market operations through the SBI (Certificate of Bank Indonesia) auction and through direct intervention in the rupiah inter-bank money market. In addition, to support open market operations, Bank Indonesia on several occasions conducted sterilization activity in the foreign exchange market to offset the expansionary impact of government rupiah expenditure financed from offshore revenue.

Implementation of the tight bias monetary policy was reflected in a gradual rise in SBI interest rates, both for one-month and three-month SBIs. However, these increases were not followed by equal increases in the interest rates on bank time deposits, although Bank Indonesia increased the margin for calculating the interest rate guarantee ceiling for bank deposits under the government blanket guarantee program from 100 basis points to 200 basis points above JIBOR.¹⁾ With rising inflation during 2000, the real interest rate on time deposits declined, leading to a smaller inflow of currency to the banking system.

With large expansion of currency, base money increase at a rapid 23.4% growth at the end of 2000 relative to the end of 1999.²⁾ High growth of base money in December 2000 was also related to strong seasonal factors in that month due to

- 1) Bank Indonesia Circular Letter Number 2/17/DPNP/2000 dated June 28, 2000 on the revision of the interest rate margin of third party deposits guaranteed by the government.
- 2) If the test date figure for base money stipulated in the Letter of Intent with the IMF is used, where this figure is calculated as the average level of base money during the last 5 days of the month and the first 5 days of the following month, base money growth in 2000 comes to 21.4%.

the simultaneous occurrence of religious festivities, the ending of the fiscal year, and prolonged year-end holidays. The increase in currency caused M1 (narrow money) to grow. However, low real interest rates in 2000 slowed the growth of M2 (broad money).

Money Supply

As discussed above, the more rapid growth of base money, particularly from May 2000, was attributed to increased currency holdings in response to higher economic activity, lower real interest rates, precautionary measures by the public, and unusually strong seasonal factors. Strong precautionary measures on the part of the public were in response to high uncertainty during the year. The largest increase in currency due to seasonal factors, as much as Rp13.9 trillion, took place in December 2000. The increase was associated with the simultaneous occurrences of religious festivities, the ending of the fiscal year, and prolonged year-end holidays, which resulted in a increase. Overall, the above factors caused currency in circulation to grow by 24.0% to Rp72.4 trillion at the end of 2000 (Table 4.1). It was this sharp increase in currency

that was the primary factor causing base money to grow by 23.4% during the year and to reach Rp125.6 trillion by the end of December 2000 (Chart 4.1). During December 2000 alone, base money rose by Rp25.4 trillion.

The other major components of base money are cash in vaults held by banks and the positive demand deposit balances held by commercial banks with Bank Indonesia. These two components of base money were relatively stable during 2000, except during the fourth quarter when they increased in anticipation of a rise in the public's demand for cash toward the end of the year. Overall, cash in vaults and bank's demand deposits with Bank Indonesia rose by Rp3.1 trillion and Rp5.8 trillion, respectively, reaching Rp17.3 trillion and Rp33.9 trillion at the end of the year.

Looking at the factors that affect base money, Net International Reserves or NIR were consistently above the targeted floor for NIR. NIR rose by \$1.4 billion to reach \$17.8 billion at the end of 2000. In December 2000 NIR was \$3.1 billion above the target level (Chart 4.2). The NIR position was adjusted downward by \$2.0 billion in May 2000 as part of a redefinition to bring Indonesia's NIR concept in line with international practice as stipulated in the Special Data Dissemination Standard (SDDS), a standardized method for calculating NIR. The SDDS includes only those components of foreign exchange reserves that are readily available and are fully controlled by the monetary authority.

Table 4.1
Base Money and Its Affecting Factors

Item	1999	2000			
		I	II	III	IV
	Trillions of rupiah				
Base Money	101.8	88.9	94.6	97.1	125.6
Bank notes and coins outside BI	72.6	59.8	64.4	65.6	89.7
– public	58.4	51.2	55.9	56.9	72.4
– bank	14.2	8.6	8.5	8.7	17.3
Banks demand deposit at BI	28.1	27.7	28.4	29.7	33.9
Private sector demand deposit	1.1	1.4	1.8	1.9	2.0
Factors Affecting					
Base Money	101.8	88.9	94.6	97.1	125.6
Net International Reserve (NIR)	114.5	129.6	113.6	116.8	124.5
Net Domestic Asset (NDA)	-12.7	-40.6	-19.1	-19.7	1.1
Net claims on central government	149.6	165.3	156.3	148.7	133.7
Liquidity support	37.2	36.9	37.3	37.3	37.3
Liquidity credit	23.7	18.6	17.7	16.7	15.9
Other claims	1.1	1.1	1.3	1.4	1.5
Money market operation	-86.9	-107.4	-98.5	-86.8	-78.9
Net other items (NOI)	-137.4	-155.2	-133.2	-137.0	-108.4

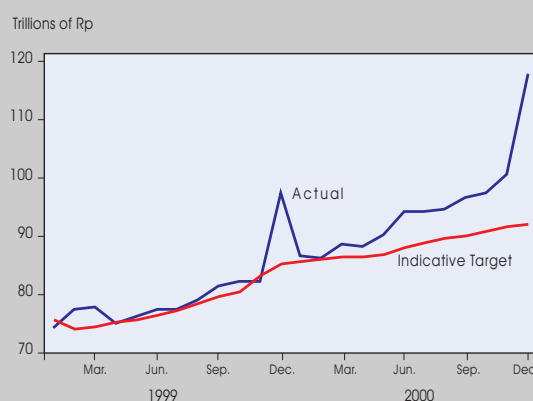
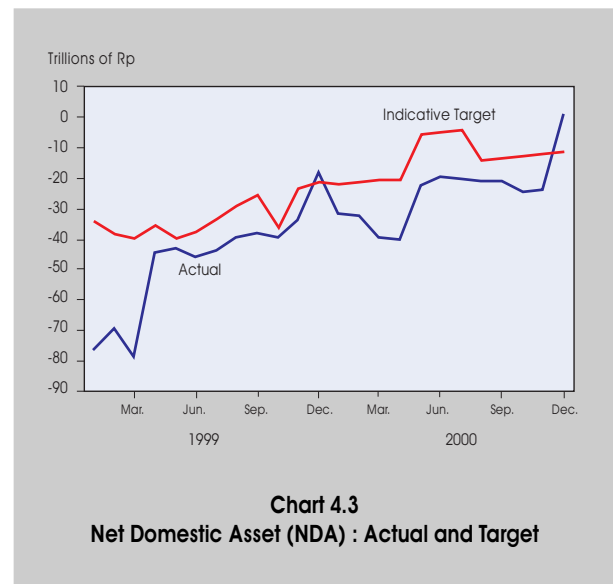
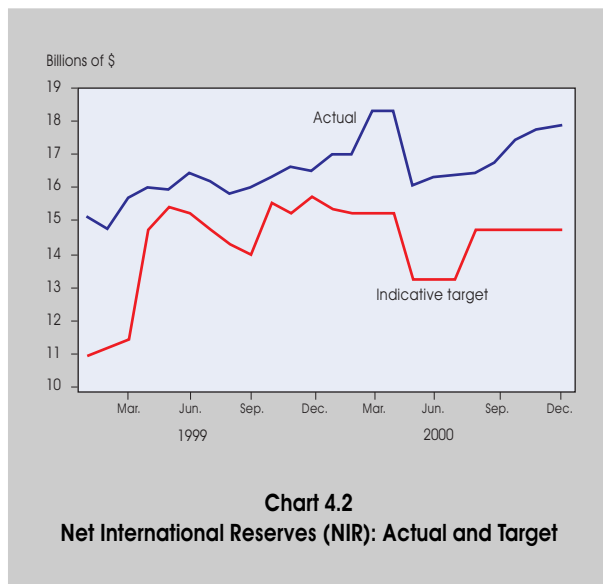

Chart 4.1
Base Money : Actual and Indicative Target



With the exception of December 2000, Net Domestic Assets (NDA) were consistently below the target during the year. The increase in NDA in the last month of the reporting year was largely due to an expansion of Net Claims on Government (NCG) at the end of the fiscal year (Chart 4.3). The rise in NDA was also associated with a seasonal increase in the public's demand for currency prior to the year-end religious festivities, as reflected in a drop in open market operations. This brought the level of NDA to Rp1.1 trillion at the end of December 2000 - the first time that NDA recorded a positive value. In December 2000, NDA surpassed its target by Rp5.0 trillion.

During the reporting period, M1 grew by 30.1% to reach Rp162.2 trillion in December 2000. The growth of M1, aside from the increase in currency, was also due to a rise in demand deposits of Rp23.5 trillion (35.5%) which was in line with higher economic activity and lower real interest rates on time deposit.

Quasi-money during the reporting period grew by 12.1% from the previous year. Looking at the components of quasi-money, savings deposits recorded the highest growth at 24.4%, while time deposits and foreign exchange denominated deposits increased by 2.1% and 24.1% respectively (Chart 4.4). High growth of saving deposits and low growth of time deposits marked a shift from time deposits to saving deposits. The shift was related to the public's desire for more liquid assets in

anticipation of higher economic activity and heightened domestic social and political uncertainty. The growing value, when measured in rupiah, of foreign currency denominated savings was more due to the depreciation of the rupiah. Measured in dollars, foreign currency denominated savings actually fell by 8.2%.

With M1 and quasi-money both increasing, M2 expanded by 15.6% to Rp747.0 trillion at the end of 2000, up from 11.9% growth in 1999 (Table 4.2). However if M2 is measured at a constant exchange rate (to remove the impact of depre-

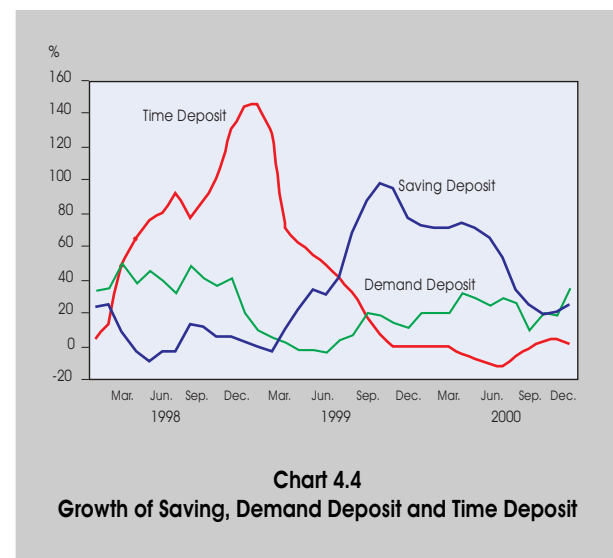

ciation on the rupiah value of foreign currency deposits), the growth during the reporting year was only 10.0%, down from 14.5% growth in 1999. With M2 growing more slowly than base money, the M2 money multiplier dropped (Chart 4.5).

Looking at the factors that affect M2, net foreign assets (NFA) of the banking system increased by Rp81.6 trillion or by 63.2% thanks to higher oil revenue. However, if the revaluation impact of rupiah depreciation is removed, NFA grew by only 20.8%. Net claims on government (NCG) of the banking system expanded by 31.0%, with the issuance of government bonds for bank recapitalization the major contributor to this rise. Claims on the business sector, including bank loans in rupiah, bank loans in foreign currency and other claims, expanded by Rp42.3 trillion and accounted for 16.8% of M2 growth. However, the increase in claims on the business sector was primarily due to a 37.7% increase in the rupiah value of foreign currency denominated bank loans, which was caused by the depreciation of the rupiah. Measured in foreign cur-

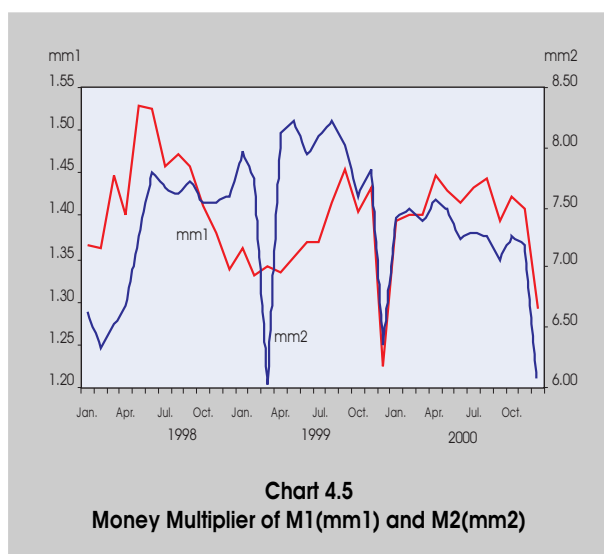

rency, bank loans denominated in foreign currency grew by only 1.9%. Measured in rupiah, bank loans denominated in rupiah grew by 8.5%. By contrast, deposits in the banking system rose significantly. This was a strong indication that the intermediary role of the banking system was not functioning properly.

Open Market Operation

In light of Bank Indonesia's tight bias monetary policy, the strategy for Open Market Operations during 2000 was to control base money so as to reduce pressure on inflation and the exchange rate, while ensuring that interest rates did not increase drastically and excessively. This strategy was reflected in the gradual increase in SBI interest rates. After reaching a low of 10.88% in mid-May 2000, the weighted average interest rate of one-month SBIs jumped to 14.53% by the end of 2000. The average interest rate of three month SBIs increased to 14.31% and that of rupiah interventions increased to 10.88% by the end of the reporting year (Chart 4.6).

Monetary control through the use of SBIs and rupiah interventions to absorb base money encountered difficulty in 2000, particularly in absorbing currency from the public, even though interest rates on these two monetary instruments rose. This was due to the fact that there was limited room for raising interest rates as a consequence of the tight bias monetary

Table 4.2
Money Supply and its Affecting factors

Item	1998	1999	2000	2000
	Change			Out-standing
	Trillions of rupiah			
M1	22.9	23.4	37.6	162.2
Currency	13.0	17.0	14.0	72.4
Demand deposit	9.9	6.5	23.5	89.8
Quasi money	198.9	45.4	63.3	584.8
Time and savings deposits in rupiah	172.3	49.9	36.1	444.7
Time deposits in foreign currency	26.5	-4.5	27.2	140.2
M2	221.7	68.8	100.8	747.0
Affecting factors				
Net foreign Assets	73.7	-12.6	81.6	210.7
Bank Indonesia	32.3	-14.6	92.0	201.2
Commercial banks	41.4	2.0	-10.3	9.5
Net claims on central government	17.5	425.3	123.1	520.3
Net claims to IBRA	29.7	-29.7	0.0	0.0
Claims to business sector	99.4	-299.7	42.3	294.9
Credit in rupiah	51.6	-172.6	12.0	152.5
Credit in foreign currency	57.7	-89.7	31.9	116.5
Other claims	-9.9	-37.4	-1.5	25.9
Others (net)	1.4	-14.5	-146.2	-278.9

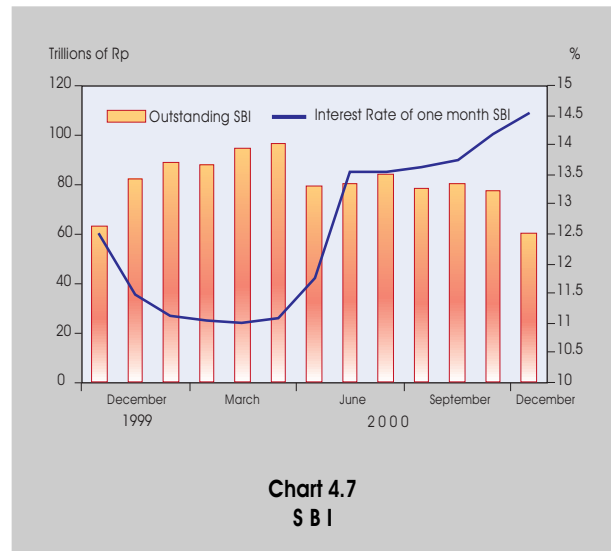
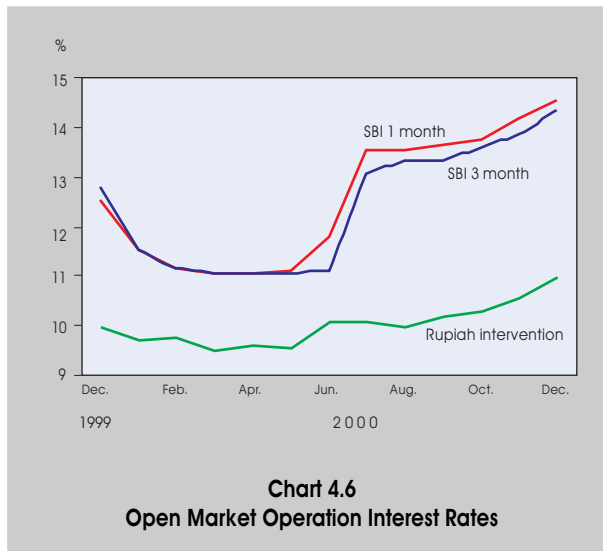

policy. Moreover, given the limited room for raising interest rates, the effectiveness of SBIs and rupiah interventions was diminished because the banking system did not respond proportionately to the monetary policy signal. This was closely related to the fact that the intermediation function of the banking system had not yet recovered. As a result, the outstanding stock of open market operations (SBIs and rupiah interventions) at the end of the year was only Rp78.9 trillion, or Rp7.9 trillion lower than the outstanding stock at the end of previous year. The stock of SBIs dropped by Rp3.0 trillion and the stock of rupiah interventions dropped by Rp4.9 trillion (Chart 4.7). Given this situation, to support its open market operations, Bank Indonesia on several occasions carried out sterilization measures in the foreign exchange market to reduce the expansionary impact of government rupiah expenditure financed from offshore revenue.

The depreciation of the rupiah, high domestic inflation, and the increase in overseas interest rates created expectations in the domestic financial market that interest rates would rise. This prompted banks to submit bids at higher interest rates in the weekly SBI auction from May 2000 on. At the same time, rising public demand for currency caused banks to hold additional liquidity. Consequently, banks shifted their funds into more liquid investments with shorter maturity, for example from three month SBIs to one-month SBIs or to rupiah interventions (Chart 4.8).

By group of banks, the largest share of SBIs were held by private national banks (46.4% of total SBIs), followed by foreign and joint banks (38.7%), state owned banks (3.5%), and regional development banks (2.3%) (Chart 4.9). Relative to the previous year, SBIs held by state owned banks decreased while the share of SBIs held by private national banks increased. This increase indicated relatively greater liquidity among private national banks compared to other groups of banks.

To maintain stability in the money market, in September 2000 Bank Indonesia, in its capacity as lender of the last resort,

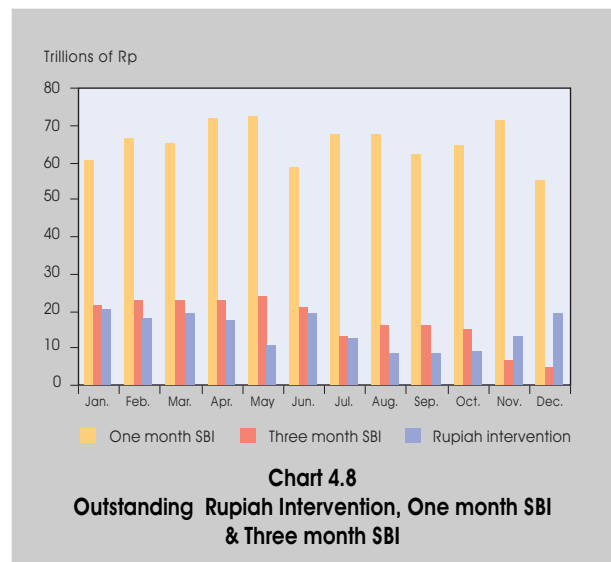

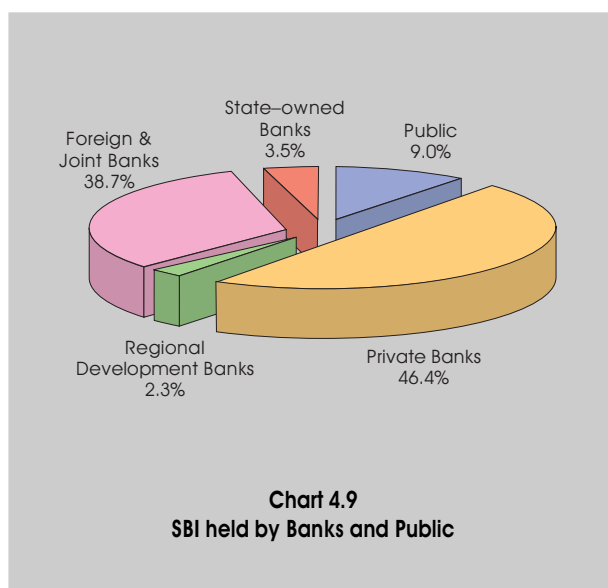

particularly after the second quarter (Table 4.3). This trend reflected rising demand for short term liquidity from banks, particularly liquidity needed by several banks to repay maturing government bonds repurchase transactions (repos), as well as to meet demand for currency prior to the August Annual Session of the MPR (People's Consultative Assembly) and for year end needs.

Despite the rising trend from a low level at the beginning of the year, daily transaction volume in the PUAB market was lower in 2000 than that of in 1999. This was related to the decreasing demand for funding from banks due to the recapitalization program. In addition, the number of banks participating in the inter-bank market dropped after the merger and closure of several banks during the reporting year. Meanwhile, despite rising PUAB interest rates after the second quarter of the reporting year, rates at the end of 2000 were lower than at the end of 1999. This indicates that the inter-bank money market during the reporting year was relatively more liquid and stable than in the previous year.

Despite large, the difference between the highest and the lowest PUAB rates in 2000 was stable, except in November 2000 (Chart 4.10). During November the highest PUAB rate soared because of surging demand for funds from several banks that faced difficulties in obtaining credit lines in PUAB in

issued a Short Term Funding Facility (FPJP) as an improvement of previous policies. In connection with the newly implemented Bank Indonesia-Real Time Gross Settlement system (BI-RTGS), Bank Indonesia provided an intra-day liquidity facility (FLI) for banks participating in the RTGS. Those two facilities were also aimed at smoothing out the payment system and sustaining banking operations. (Box : Intraday and Short-term Liquidity Facilities).

In order to develop the money market and monetary instruments for sharia banks, Bank Indonesia issued regulations on the inter-bank money market,³⁾ the minimum reserve requirement in rupiah at 5.0% and in foreign exchange at 3.0%,⁴⁾ and open market operation instruments⁵⁾ for banks operating on the sharia principle.

Inter-Bank Money Market

Both daily transaction volume and interest rates in the inter-bank money market (PUAB) were on an upward trend in 2000,

- 3) PBI Number 2/8/PBI/2000 dated February 23, 2000 on stipulation of inter-bank money market for banks based on the Sharia principle
- 4) PBI Number 2/7/PBI/2000 dated February 23, 2000 on the minimum reserve requirement in rupiah and foreign exchange for banks based on the Sharia principle.
- 5) PBI Number 2/9/PBI/2000 dated February 23, 2000 on the stipulation of the Bank Indonesia Wadiah promissory notes.

Table 4.3
Interest Rate and Volume on Daily Interbank Money Market Transactions

Item	Interest Rate (%)			Volume (Billions of Rp/Day)		
	Morning	Afternoon	Overall	Morning	Afternoon	Overall
Trw I /1999	39.56	37.83	38.97	3,074	2,075	5,149
Trw II /1999	29.13	28.21	28.67	2,627	2,624	5,252
Trw III /1999	13.28	13.10	13.21	1,964	1,420	3,384
Trw IV /1999	12.46	12.34	12.39	2,040	1,731	3,771
Trw I /2000	9.74	9.37	9.59	1,003	708	1,712
Trw II /2000	10.18	9.86	10.02	961	945	1,907
Trw III /2000	11.18	10.64	10.89	1,197	1,289	2,486
Trw IV /2000	11.64	11.21	11.43	1,340	1,470	2,810

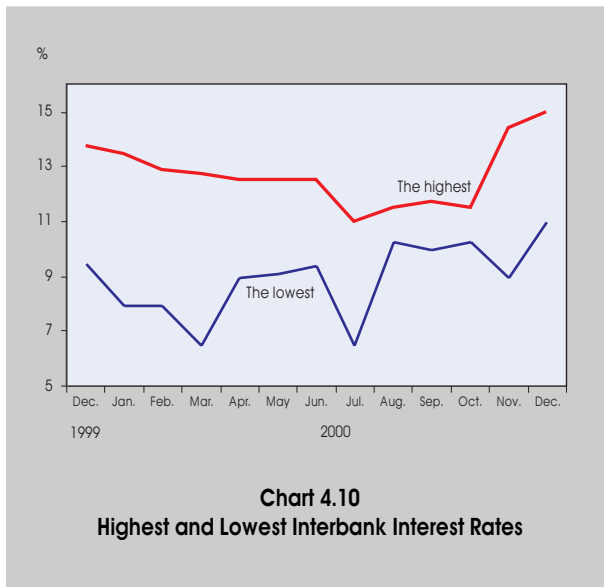

Chart 4.10
Highest and Lowest Interbank Interest Rates

the approach to implementation BI-RTGS. This indicated the continued existence of money market segmentation, albeit on a smaller scale than in previous years.

National private foreign exchange banks tended to be net-lenders in the inter-bank market in 2000 (Chart 4.11). State-owned banks were net-borrowers during the first part of the year but became net-lenders from September 2000. This was related to the improved liquidity position of state-owned banks following the completion of their recapitalization program. As recap-

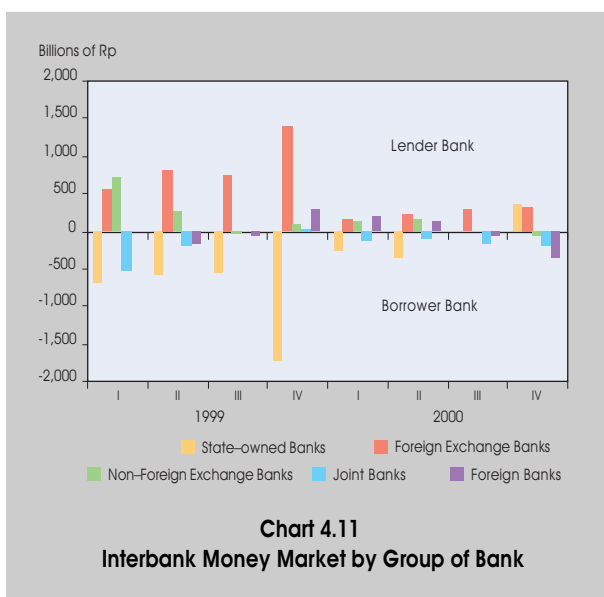

Chart 4.11
Interbank Money Market by Group of Bank

italized banks, they were allowed to sell 25.0% of their outstanding government bonds in the secondary market. In contrast, foreign banks switched from being net lenders during the first part of the year to being net borrowers since the third quarter.

Interest Rate

In line with rising SBI rates after May 2000, PUAB and one-month time deposit rates increased gradually, although at a different speed and at a lower level than in the previous year (Chart 4.12). PUAB and one-month deposit rates rose by 1.84% and 1.63% respectively to reach 11.41% and 12.0% at the end of December 2000 (Table 4.4). The relatively slower increase of PUAB and one-month deposit rates compared to SBI rates was related to higher liquidity in the banking sector from the expansion of government finance. However, the increase in liquidity occurred while the intermediary function of the banking system had not yet fully recovered. The liquidity situation was also partly due to the effort by banks to maximize revenues from the higher gap between SBI rates and deposit rates.

The slow increase in deposit rates at the same time that the inflation rate was rising caused real bank deposit interest rates to fall to 2.56% at the end of December 2000 (Chart 4.13). This reduced the incentive to minimize cash holdings in favor of bank deposits. Meanwhile, longer term interest rates, par-

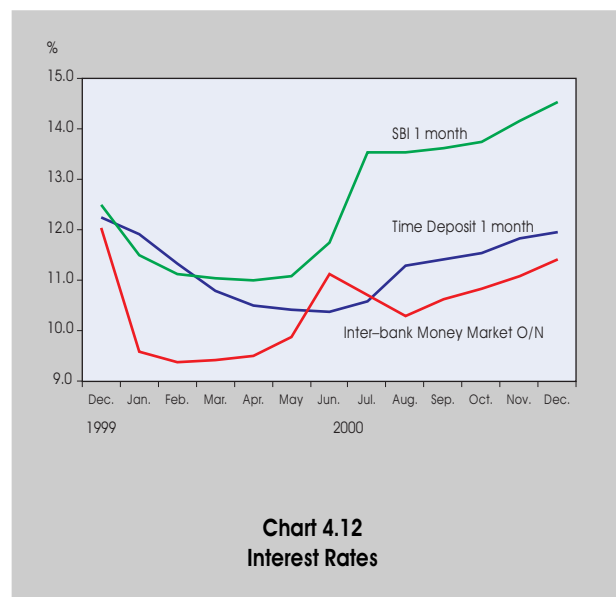
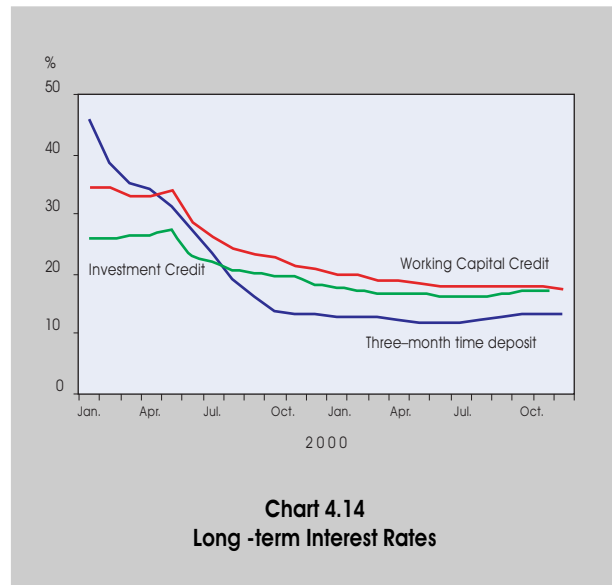

Chart 4.12
Interest Rates

Table 4.4
Interest Rates¹⁾

Item	1998	1999	2000
	In percent		
SBI			
1 month	38.4	12.5	14.5
Interbank Money Market			
O/N	33.4	12.1	11.4
Overall	39.5	12.4	12.3
Time Deposit			
1 month	41.4	12.2	12.0
3 month	49.2	12.9	13.2
6 month	36.8	14.3	13.3
12 month	28.3	22.4	12.2
24 month	16.6	18.4	14.3
Credit			
Working Capital	34.7	20.7	17.7
Investment	26.2	17.9	16.9

1) Weighted Average in December



ticularly the lending rate for working capital and investment, appeared to be relatively stable (Chart 4.14). This was related to the incomplete recovery of the bank intermediary role.

Capital Market

Persistent domestic social and political turmoil, exchange rate depreciation, and high SBI interest rates undermined the performance of the stock market in 2000. The Jakarta Stock Exchange Composite Index at the end of the reporting year stood at 416.3, down 62.6% or 260.6 points from the previous end-of-

year level (Chart 4.15). Market capitalization dropped by 42.5%, from Rp451.8 trillion at the end of 1999 to 259.6 trillion at the end of 2000. The decline in the composite index during the reporting year was also related to a reduced activity from foreign investors. The foreign investor share of total transactions shrank from Rp51.7 trillion (35.0%) in 1999 to Rp24.8 trillion (20.2%) in 2000. Despite reduced performance, the number of listed companies in the stock market during the reporting year rose from 321 companies with a total market value of Rp206.7 trillion to 346 companies with a total market value of Rp225.6 trillion.

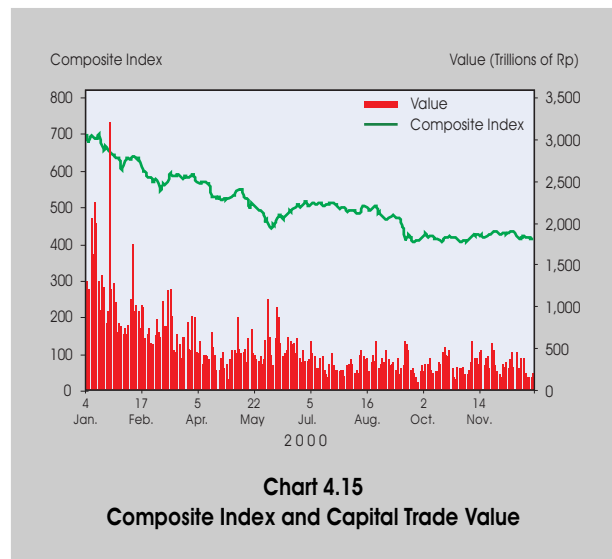
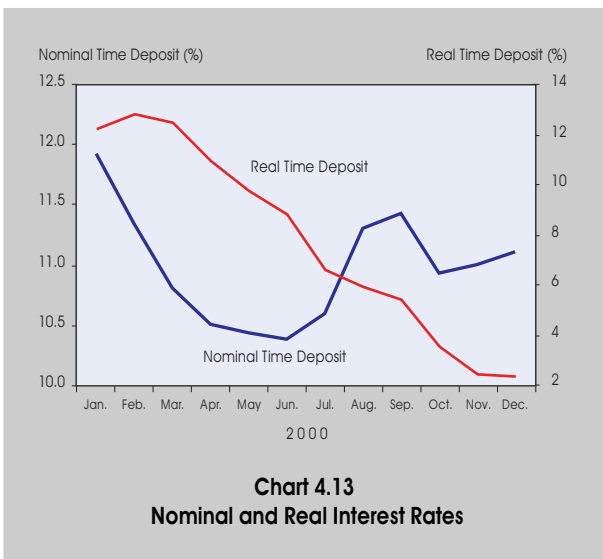

To help boost the performance of the stock market during 2000, the government took several measures, including allowing a smaller price fraction for stocks. In the face of strong negative sentiment caused by the domestic social and political situation, this policy did not seem to contribute significantly to improve stock market performance.

Trading activity in the stock market during 2000 was also marked by the inclusion of the sharia principle in the stock market from July. A sharia based stock composite index was determined by the performance of 30 listed equities whose activities were not against the Islamic sharia principle. In line with the movement of the Jakarta Stock Exchange composite index, the Jakarta Islamic index also dropped from a starting of 78.5 to 57.9 at the end of 2000.

In contrast to the stock market, the corporate bond market made some notable progress. The number of bond issuers increased from 76 companies with Rp15.9 trillion in bonds to 91 companies with the Rp22.4 trillion in bonds. The index of bond trading jumped by 64.6% from 252.2 at the end of 1999 to 415.0. The increase was accompanied by higher daily trading activity, from Rp4.9 billion to Rp10.7 billion, with market capitalization of Rp18.9 billion.

The increase in daily trading activity reflected the growing interest in the bond market as a source of financing. Com-

panies turned to the bond market partly in response to the limited availability of bank financing and the rise in interest rates in the money market.

Trading of government bonds in the secondary market, either outright trades or repurchase agreements, also showed some improvement. Trading activity got a boost from the decision to raise the ceiling on the amount of government recapitalization bonds held by banks that could be sold in the secondary market. This ceiling rose from 10.0% in February to 15.0% in September and to 25.0% by December 2000.^{6,7,8)} Government bond transactions in the secondary market from February 2000 reached Rp27.9 trillion, consisting of variable-rate bond transactions of Rp16.2 trillion and fixed-rate bond transactions of Rp11.7 trillion (Box : The Development of a Secondary Market for Government Bonds).

In order to increase trading activity in the secondary market for government bonds, the government also launched the government bond exchange offer program. This program was implemented through the exchange of government five-year bonds held by the recapitalized banks carrying a fixed rate of 12.0% with two different types of bonds (stapled bonds) carrying interest rates of 16.5% and 10.0%.

-
- 6) PBI Number 2/10/PBI/2000 dated March 29, 2000 on the revision of government bonds portfolio for recapitalized banks.
 - 7) Bank Indonesia circular letter Number 2/18/DPM dated September 19, 2000 on the increase of the percentage of government bonds portfolio for recapitalized banks.
 - 8) Bank Indonesia circular letter Number 2/25/DPM on the increase of the percentage of government bonds portfolio for recapitalized banks.

Box : The Development of a Secondary Market for Government Bonds

Trading activity of government bonds in the secondary market was still very limited although the government increased the portion of bank recapitalization bonds that could be traded in the secondary market. Efforts to boost trading of government bonds in the secondary market through the introduction of stapled bonds had not yet shown significant results as of the end of the year. The government and Bank Indonesia continue to take necessary measures to create an active secondary market for government bonds.

The amount of outstanding bonds issued by the government for the bank recapitalization program through the end of December 2000 was Rp431.8 trillion, consisting of Rp179.4 trillion in fixed rate bonds (41.6% of the total), Rp219.5 trillion in variable rate bonds (50.8% of the total) and Rp32.9 trillion (7.6% of the total) in hedge bonds (Chart 1).

The value of government bonds included in the trading portfolio by the end of 2000 was only Rp31.6 trillion (7.3%) - including Rp12.1 trillion treated as collateral - while the remaining Rp400.2 trillion was held in the investment portfolio (Chart 2). The trading portfolio was far smaller than the portfolio of government bonds that could be traded, as the latter was equal to 25 percent of the total amount of fixed rate bonds and variable rate bonds.

When initially issued, variable rate bonds greatly exceeded fixed rate bonds. The decision to issue more variable

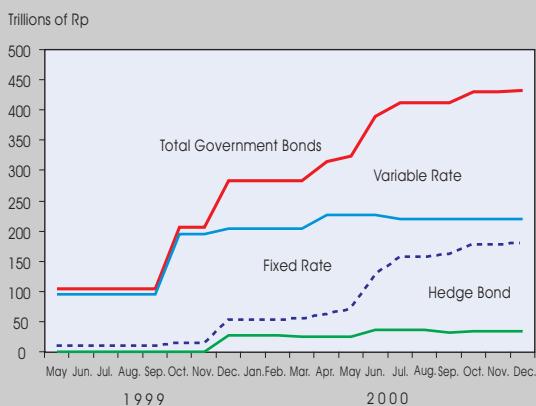

Chart 1
Issued Government Bonds

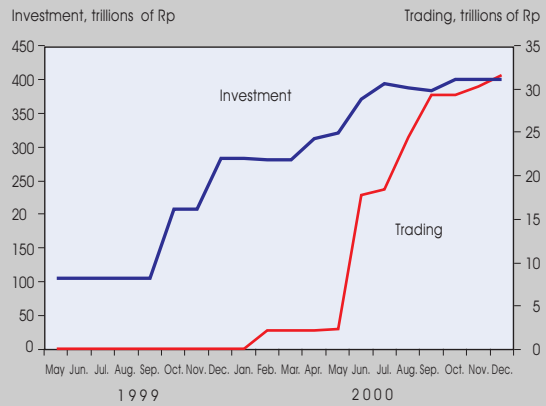

Chart 2
Portfolio of Government Bonds held by Banks

rate bonds was based on the assumption that future interest rates would decline, so that issuing a large proportion of variable rate bonds would reduce the interest burden on the state budget. However, as SBI interest rates began to rise after May 2000, the government issued more fixed rate bonds than variable rate bonds in an effort to balance the composition of the overall stock of bonds in the market and to reduce the interest burden on the state budget.

Transactions in bank recapitalization bonds were dominated by repurchase agreements (repo) rather than by outright transactions as can be seen in Table 1. The attractiveness of repurchase agreements was related to the lower risk and shorter term of such transactions. Transaction volume for variable rate bonds was Rp16.2 trillion, while for fixed rate bonds was Rp11.7 trillion. The higher activity level for variable rate bonds was due expectations that the interest rate on variable rate bonds would rise, since the coupon on variable rate bonds is based on the three month SBI interest rate and SBI rates began to rise after May 2000. The most actively traded bonds were those with relatively short maturity period (3–4 years), including the VR0001 series maturing on June 25, 2002 and the VR0002 series maturing on February 25, 2003.

To boost transactions in the secondary market and to help recapitalized banks increase their liquidity, the government and Bank Indonesia took the following policy measures :

Table 1
Recapitalization Bond Transactions

Month	FR	VR	Total
	Billions of rupiah		
February	-	6	6
March	-	-	-
April	-	-	-
May	26	62	87
June	7,000	1,587	8,587
July	-	86	86
August	1,053	2,788	3,842
September	419	2,284	2,703
October	-	798	798
November	2,277	5,372	7,649
December	922	3,227	4,149
Total Transaction	11,696	16,210	27,906
Type of Transaction			
- Repo			13,999
			50.2%
- Outright			13,906
			49.8%

1. On November 30, 2000, the government offered banks holding government recapitalization bonds the opportunity to participate in the bond exchange offer program.¹⁾ The recapitalization bonds that could be exchanged were the FR0001 series maturing on September 15, 2004 and the FR0003 series maturing on May 15, 2005 carrying an interest rate of 12.0%. The FR0001 series could be exchanged for two new stapled bond series, the FR0006 series carrying an interest rate of 16.5% and the FR0007 series carrying an interest rate of 10.0%. The FR0003 series could likewise be exchanged for two new stapled bond series, the FR0008 series carrying an interest rate of 16.5% and the FR0009 series carrying an interest rate of 10.0%. Each bank that exchanged recapitalization bonds for stapled bonds would receive stapled bonds in fixed proportions so that the weighted average interest rate

1) The Bond Exchange Offer is a program offering stapled bonds in exchange for recapitalization bonds. Two types of stapled bonds are offered, in fixed proportions, with the first type carrying a higher interest rate than the original recapitalization bond and the second type carrying a lower interest rate, but with the weighted average interest rate on the stapled bonds being equal to the interest rate on the original recapitalization bond to be exchanged.

on the stapled bonds was identical to the interest rate on the original recapitalization bonds. This was done so that the government's fiscal burden would remain unchanged. As of the end of the reporting year fourteen banks had exchanged recapitalization bonds for stapled bonds, with the value of the bonds exchanged coming to Rp58.5 trillion or 90.1% of the total FR0001 and FR0003 series. However, there were no transactions in the new stapled bonds in the secondary market as of the end of the year.

2. The government is currently drafting a bill on government bonds to provide a legal basis for the issuance of government bonds and to increase investor confidence. The draft law stipulates that the government guarantees payment of the coupon and of the principal at maturity (standing appropriation).
3. The government is also planning to issue Treasury Bills, and it is expected that these will be issued in the second quarter of 2001.
4. Bank Indonesia, together with market participants,²⁾ is also in the process of designing the rules of conduct for bond trading based on the repurchase agreement mechanism, both for repurchase agreement transactions among market participants or repurchase agreement transactions between Bank Indonesia and market participants.

The trading of government bonds is expected to become more active in 2001 in line with the recent implementation of the BI-RTGS system. This is related to the increasing demand by banks for government bonds as an alternative to SBIs that can be used as collateral to obtain Bank Indonesia intra-day (FI) and short-term (FPJP) liquidity facilities.

With the various measures and facilities already introduced and being prepared together by the government and Bank Indonesia, it is expected that the secondary market for government bonds will be more active.

2) The market participants include various parties from the domestic banking community (including foreign banks), foreign securities firms, the association of fixed income dealers, and national securities firms.

Box : Intraday and Short-term Liquidity Facilities

Bank Indonesia introduced the short term liquidity facility (FPJP) and the intra-day liquidity facility (FLI) to enhance the effectiveness of Bank Indonesia in carrying out its duties.

As lender of the last resort, Bank Indonesia is permitted to provide credit to banks to help resolve their short term funding problems.¹⁾ The issuance of the Bank Indonesia regulation on FPJP was a revision of the previous regulation.²⁾ Under the FPJP scheme, the short term funding problem is defined as a funding mismatch experienced by a commercial bank which could lead to a debit balance in its account at Bank Indonesia.

To ensure the effectiveness of its function as lender of last resort in facilitating the FPJP, Bank Indonesia maintains higher interest rates on the FPJP facility than market rates. The FPJP interest rate is determined based on the highest of the following interest rates:

- a. The weighted average overnight interest rate in the inter-bank money market during the previous working day, plus a margin of 200 basis points, or
- b. The weighed average interest rate of the one-month SBI in the last auction plus a margin of 200 basis points.

Bank Indonesia provided the FPJP facility with a maturity period of one working day or overnight, while the FPJP is available for at most 90 consecutive days.

Meanwhile, the regulation of FLI was part of Bank Indonesia's duty to support the payment system.³⁾ FLI is aimed at helping banks deal with short term liquidity mismatches that have the potential to cause gridlock in the Bank Indonesia Real Time Gross Settlement (BI-RTGS) system. Gridlock could in turn disrupt the payment system nationwide and create instability in the overall financial system and the monetary situation. The short term liquidity mismatch could occur when outgoing transactions via the BI-RTGS system at a particular point in time exceed the outstanding balance of a participating bank's account with Bank Indonesia. This situation could develop if there is a timing mismatch

between outgoing and incoming transactions or if at a certain point in time the incoming value is less than the outgoing value.

The use and repayment of FLI by a bank that must have been approved by Bank Indonesia one day prior to the transaction (T-1), is implemented automatically by the BI-RTGS system. At T+0, a bank can use the FLI from 8.30 a.m. until 6 p.m. every time the bank's rupiah account in Bank Indonesia is not sufficient to execute outgoing transactions. Meanwhile, FLI repayment is executed from 8.30 a.m. until 7 p.m. for every incoming transaction. When a bank fails to repay its FLI by the 7 p.m. deadline, the FLI is converted into FPJP.

To avoid moral hazard by banks, the recipient banks must provide collateral when requesting the FLI and FPJP. The collateral must be of high quality, must be liquid and must be at least equal in value to the facility obtained. The types of collateral accepted by Bank Indonesia include:

- a. SBI notes with remaining maturity of 3 to 30 days with market value of at least 100% of the credit facility obtained by the banks.
- b. Government bonds with remaining maturity of 15 days with market value of at least 115% of the credit facility obtained.
- c. Other security notes as determined in the future by Bank Indonesia.

The collateral must be free of any form of dispute and must not be pledged to other parties or to Bank Indonesia for other transactions. Moreover, banks that obtain the facility may not sell pledged collateral or pledge such collateral to other parties.

Bank Indonesia has the right to oversee banks obtaining the credit facility either prior to or during the utilization period of the facility. In addition, banks applying for the facility are required to fulfill the existing minimum capital adequacy ratio (KPMM) and must fulfill bank soundness requirements for the last three months.

1) Act Number 23/1999 on Bank Indonesia article 11.

2) PBI Number 1/1/PBI/1999 dated May 18 1999 on Funding Facility in the bid to Resolve Short Term Problem.

3) Act Number 23/1999 on Bank Indonesia article 15.

A long, empty hallway with classical columns and a tiled floor, leading to a door with two decorative windows. The hallway is brightly lit, with light streaming in from the windows and reflecting off the polished floor. The columns are white and have a fluted design. The floor is made of square tiles. The door at the end of the hallway has two rectangular windows with a diamond-patterned lattice. The overall atmosphere is clean and formal.

Chapter 5 *Balance of Payments*

Indonesia's overall balance of payments situation improved in 2000. The main source of improvement was rising exports of non-oil and gas products and increased revenue from oil and gas exports due to higher international oil prices. However, due to the high import content of Indonesia's exports, the more rapid growth of non-oil and gas exports led to an increase in non-oil and gas imports, particularly raw material imports. Imports also grew because of the relatively strong recovery of domestic economic activity. Meanwhile, the deficit in the services account widened due to huge interest payments on foreign debt, larger contract sharing payments to production sharing contractors, and higher freight costs resulting from increased import activity.

Overall, the current account in 2000 continued to record a surplus, and the surplus actually exceeded that in the previous year. However, the capital account remained in deficit, with lower net official capital inflows and a persistent large deficit in net private capital flows. Overall Indonesia recorded a balance of payments surplus in 2000 of \$5.0 billion, allowing international reserves to reach \$29.3 billion by the end of the year, which was equivalent to 6.3 months of imports plus official debt repayment (Table 5.1).

The development of the balance of payments was related to several measures taken by the government during the reporting year. To boost non-oil and gas exports, the government took a number of measures, including a gradual cut in export taxes¹⁾, the issuance of export quotas on textiles and textile product²⁾, provision of financing and guarantees, and consultation. The government also pushed for the expansion of export markets through the reorganization of trade missions and by intensifying trade diplomacy in the framework of bilat-

- 1) Minister of Finance Decree Number 387/KMK.017/2000 dated September 12, 2000 on palm oil export tax, CPO, and its derivatives .
2) Minister of Trade and Industry Decree Number 174/MPP/Kep/5/2000 quotas of export textiles and textile products

eral, regional and multilateral relations. The target of expansion included export destinations in the Middle East, East Europe, Latin America, and East Asia.

Table 5.1
Indonesia's Balance of Payments

Item	1998	1999	2000*
	Billions of \$		
A. Current Account	4.1	5.8	7.7
1. Goods	18.4	20.6	25.1
a. Exports f.o.b	50.4	51.2	62.5
Non-oil and gas	43.0	41.0	47.0
Oil and gas	7.4	10.3	15.5
Oil	4.1	5.7	8.6
LNG	3.0	4.2	6.4
LPG	0.2	0.4	0.4
b. Imports f.o.b	-31.9	-30.6	-37.4
Non-oil and gas	-29.1	-26.6	-32.1
Oil and gas	-2.9	-4.0	-5.3
Oil	-2.6	-3.7	-5.0
LNG	-0.2	-0.3	-0.3
2. Services	-14.3	-14.9	-17.4
a. Non-oil and gas	-11.4	-11.7	-12.7
b. Oil and gas	-2.9	-3.2	-4.7
Oil	-1.4	-1.5	-2.3
LNG	-1.5	-1.7	-2.4
B. Capital Account	-3.9	-4.6	-4.6
1. Net official capital	10.0	5.4	3.8
a. Official inflows	13.7	9.4	8.3
b. Debt repayments	-3.8	-4.1 ¹⁾	-4.5 ¹⁾
2. Net private capital	-13.8	-9.9	-8.5
a. Direct Investment	-0.4	-2.7	-4.1
b. Others	-13.5	-7.2	-4.4
C. Total (A+B)	0.2	1.2	3.1
D. Net Errors and Omissions (C and E)	2.1	2.1	1.9
E. Monetary Movements	-2.3	-3.3	-5.0
Note :			
1. Net International Reserves (NIR)	14.1	16.4	17.8
2. Gross Foreign Assets (GFA) ²⁾	23.8	27.1	29.3
equivalent to non-oil and gas imports, and official foreign debt repayments (months)	5.7	6.7	6.3
3. Current account deficit/GDP (%)	4.2	4.1	5.0

- 1) Including rescheduling
2) Since 2000, based on IRFCL concept

The strong growth of imports was also linked to various steps taken by the government to restructure international trade. In a bid to boost domestic industry, which requires imported raw materials, the government improved various guarantee and financing schemes, and reopened access to international markets. Equal opportunity was given to exporters grouped in the so-called PET (selected exporting companies) scheme and non-PET exporters, including in utilizing the guarantee and financing scheme, and by canceling the limit on imported commodities that can enjoy government guarantee and financing facilities and increasing the number of banks that can provide letters of credit (L/Cs) for import purposes. During the reporting year, the government via Bank Indonesia maintained its guarantee on all L/Cs opened by Indonesian banks, so that local banks could again have access to overseas banks. To ensure the supply of raw materials for domestic industry, the government also continued the import duty exemption facility on the import of certain commodities.³⁾ The government also issued a policy on the requirements for the import of completely built up vehicles.⁴⁾

With regard to capital flows, in a bid to reduce the payment burden of government foreign debt, the Paris Club II meeting was held on April 12-13, 2000 in Paris. The meeting agreed to reschedule principal payments on debt, including both Official Development Assistance (ODA) loans and non-ODA loans, maturing between April 1, 2000 and March 31, 2002. In September 2000, an agreement was also reached under the framework of the London Club to reschedule principal payments on commercial debt obtained from a syndication of overseas banks. The agreement was a consequence of the comparable treatment requirement demanded by the Paris

Club donor nations. Meanwhile, the restructuring effort for the private sector's overseas debt via the Jakarta Initiative Task Force and the Exchange Offer Program continued during the reporting year.

As a follow up measure to the foreign exchange activity monitoring policy, Bank Indonesia during the reporting year issued a regulation requiring non-bank financial institutions to report their foreign exchange activities to Bank Indonesia. This requirement had already been applied to banks.⁵⁾ With this new regulation, it was expected that the foreign exchange activity monitoring system would cover most of the transactions made by residents (Box : Monitoring of Foreign Exchange Activity through Banks and Non-Bank Financial Institutions).

Current Account

During the reporting year, the current account registered a surplus of \$7.7 billion or an increase of 33.0% compared to a surplus of \$5.8 billion in the previous year. The current account surplus stemmed mainly from a \$25.1 billion surplus in the trade balance (Chart 5.1). The sharp increase in the trade surplus was primarily due to higher oil and gas revenue as a result of higher international oil prices. The non-oil and gas trade surplus was only \$14.9 billion, which was almost the same as in the previous year (Chart 5.2). Meanwhile, the services account registered a deficit of \$17.4 billion, higher than the \$14.9 billion deficit in the previous year.

Exports

Export of both oil and gas and non-oil and gas merchandise grew strongly in 2000. Total exports reached \$62.5 billion, an increase of 22.0% from the previous year. With this strong performance exports became the engine of economic growth in the reporting year.

Non-oil and gas exports in the reporting year rose by 15.0% to \$47 billion while oil and gas exports jumped by

3) Minister of Finance Decree Number 98/KMK.05/2000 dated March 31, 2000 on import duty facility for raw materials/components for electronic products, and Minister of Finance Decree Number 135/KMK.05/2000 dated May 1, 2000 on import duty facility on imports of machinery/goods and materials for industry development.

4) Minister of Trade and Industry Decree Number 49/MPP/Kep/2/2000 dated February 25, 2000 and Decree Number 192/MPP/Kep/6/2000 dated June 2, 2000 on the conditions for the imports of completely built up vehicles.

5) Bank Indonesia Circular Letter Number 2/23/DSM dated November 10, 2000 on the reporting of foreign exchange transaction activity by non-bank financial institutions.

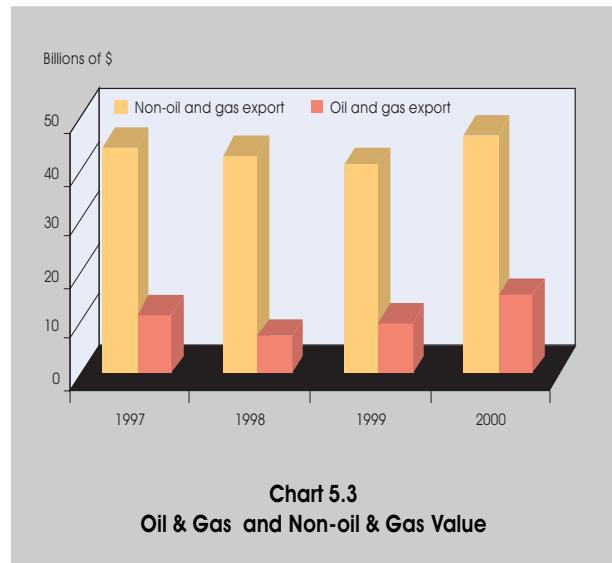
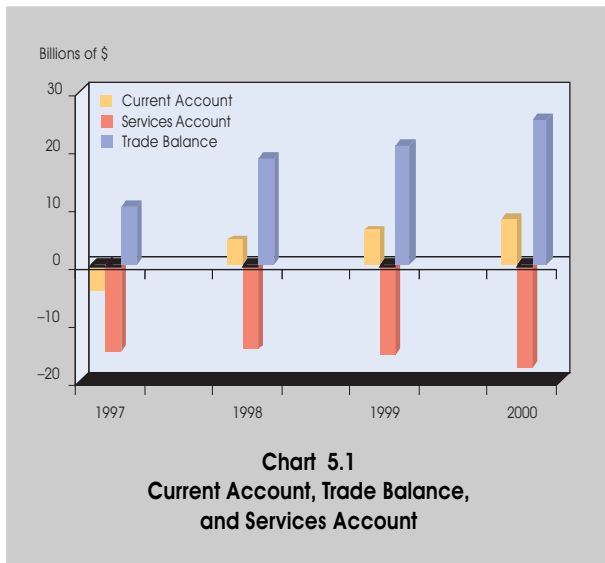

50.5% to \$15.5 billion (Chart 5.3). The growth of non-oil and gas exports was due to higher world demand, particularly from countries in the American and Asian region, and also to supportive government policies promoting export activity.

The increase in non-oil and gas exports was due to export growth from the industrial and mining sectors. The industrial sector was still the largest contributor to Indonesia's non-oil and gas exports, accounting for around 80.0% of total non-oil and gas exports, followed by mining with an 11.0% share and agriculture with a 9.0% share (Chart 5.4).

Exports of industrial goods in the reporting year increased by 15.0% relative to the previous year and reached \$37.6 billion (Table 5.2). The sharp increase in the export of industrial goods was largely due to growing exports of machinery and mechanical appliances (77.4%), electronic goods (70.8%), paper (14.1%), and textiles and textile products (6.4%). Growth of industrial exports was due to increased paper prices in the international market and strong international demand for textiles and textile products, electrical goods, and machinery and mechanical appliances.

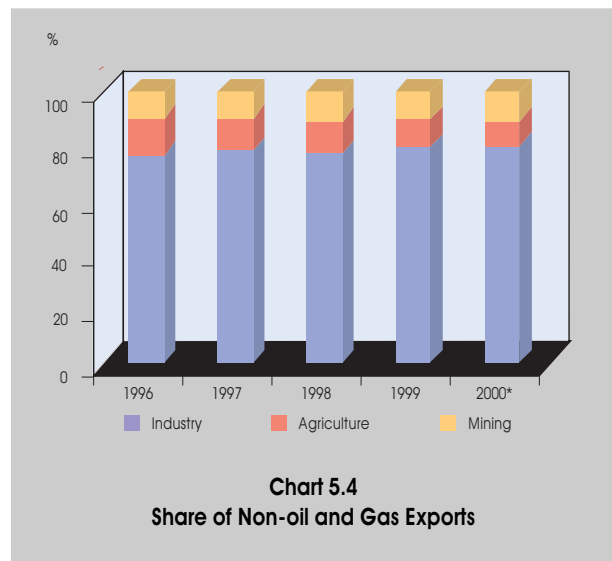
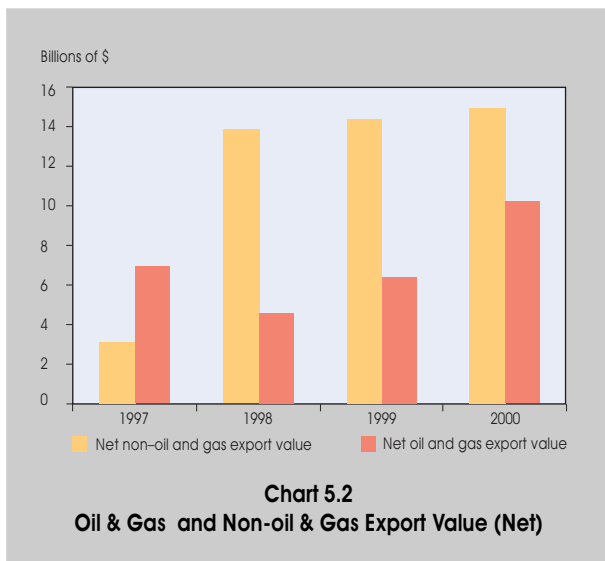

Table 5.2
Industrial Goods Exports

Item	1999	2000	2000*	
	Growth (%)		Value (millions of \$)	Share (%)
Textile and textile products	-10.6	6.4	6,693	17.8
– Garments	-8.5	7.3	3,702	9.8
Handicrafts	-72.8	-9.4	515	1.4
Wood and wood products	6.6	-6.3	4,239	11.3
– Plywood	-3.0	-14.3	1,936	5.1
Rattan products	559.6	11.8	285	0.8
Palm Oil	54.2	-12.4	1,199	3.2
Copra oil-cake	-9.1	6.5	50	0.1
Chemical products	-12.5	15.5	2,065	5.5
Metal products	-22.3	3.0	1,111	3.0
Electrical appliances	19.6	70.8	5,746	15.3
Cement	64.1	-3.5	138	0.4
Paper	7.0	14.1	3,017	8.0
Rubber product	-9.8	8.1	405	1.1
Glass and glassware	3.9	20.7	337	0.9
Footwear	-4.0	3.7	1,575	4.2
Plastics products	-8.0	27.8	1,099	2.9
Machinery and Mechanical	25.3	77.4	3,287	8.7
Others	7.5	3.6	5,874	15.6
Total			37,634	100

Exports from the mining sector rose by 25.3% from a year earlier and reached \$5.2 billion. Copper was the largest contributor to growth of mining exports with an export value of \$2.1 billion, up 47.3% from the previous year. The rise in copper export value was due both to volume growth and to higher international prices for copper.

Exports of agricultural products in the reporting year increased by \$58 million to \$4.2 billion. The major contributors to growth included rubber, which grew by 5.2%, and shrimp, which grew by 5.9%.

In terms of destination countries, Indonesia's non-oil and gas exports mostly went to countries in the Asian region. Asian countries absorbed 57.0% of Indonesia's non-oil exports, followed by the American Countries (20.0%) and Europe (19.0%). The biggest export destination in the Asian region was the ASEAN countries, followed by Japan and China (Chart 5.5).

The strong growth of oil and gas exports during the reporting year was primarily due to higher oil and gas prices in the international market. The average price of Indonesian oil

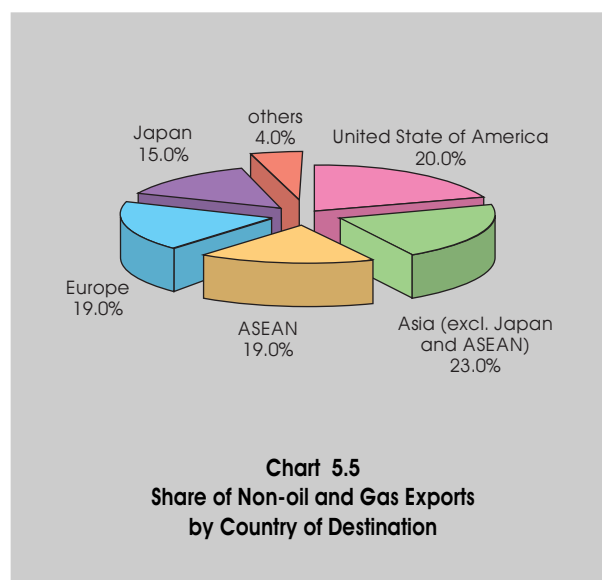

products in 2000 was \$28.6 per barrel, much higher than last year's average price of \$17.4 per barrel and well above the state budget assumption of \$20.0 per barrel. The increase in oil prices was due to compliance by OPEC member countries with production quotas and a decline in the supply of oil in the international market as a result of rising tension in the Middle East. The average export price for both liquefied natural gas (LNG) and liquefied petroleum gas (LPG) also soared to \$4.58 per MMBTU and \$295.2 per Mton, respectively, from \$2.76 per MMBTU and \$197.4 per Mton in the previous year.

In terms of the components, oil exports jumped by 50.9% and LNG exports rose by 54.8%, while LPG exports remained relatively constant.

Although the value of oil and gas exports increased, export volume declined. The export volume of oil, LNG, and LPG fell by 8.5%, 6.9%, and 26.9%, respectively. The drop in oil export volume was caused by lower crude oil production. The lower export volume of gas was caused by the conclusion of short-term LNG purchase contracts with buyers from Korea, among other reasons.

Imports

Import value rose by 22.2% in the reporting year after a 4.1% decline in the previous year. Both non-oil and gas and oil

and gas imports rose, with non-oil and gas imports up 20.7% and oil and gas imports up 32.5% from the previous year. The rise in non-oil and gas imports was in line with growing domestic demand. The increase in oil and gas imports was due to insufficient domestic production to fulfill growing demand.

The growth of non-oil and gas imports was due to growth in all three major categories of non-oil and gas imports. Imports of consumption goods grew by 63.3%, imports of raw materials grew by 20.6% and imports of capital goods grew by 10.6% (Table 5.3). However, raw materials continued to dominate non-oil and gas imports, accounting for 72.9% of non-oil and gas import value. The growth of raw material imports was due to a 25.4% increase in imports of semi-processed materials for industry and a 119.6% increase in spare parts and equipment for transport vehicles (Table 5.4). This reflected higher domestic production activity, as did the increase in capital goods imports (Table 5.5).

Indonesia's imports primarily came from the Asian region and the U.S. The share of imports from Asia, particularly Japan, doubled from 9.5% to 18.5% with import value totaling \$5.9 billion. The share of imports from China soared from 3.9% to 6.4% with import value of \$2.1 billion, while the share of imports from the U.S. rose slightly from 9.5% to 12.0%, equivalent to \$3.8 billion (Chart 5.6).

Services

The deficit in the services account soared by \$2.5 billion to \$17.4 billion in the reporting year. The growth of the services deficit

Item	Growth (%)		Value (Millions of \$)		Share (%)	
	1999	2000	1999	2000	1999	2000
	Consumption goods	-18.2	63.3	1,343	2,198	5.0
Auxiliary goods	-0.6	20.6	19,398	23,392	72.8	72.9
Capital goods	-25.7	10.6	5,891	6,514	22.1	20.3

Table 5.4
Imports of Raw Material Goods

Item	1999*	2000*	2000	
	Growth (%)		Value (Millions of \$)	Share (%)
Food and beverages mainly for industry	4.5	11.8	770.6	3.3
Processed food and beverages	38.6	-8.2	605.9	2.6
Primary raw materials	10.8	-24.8	2,061.3	8.8
Processed raw materials	-13.5	25.4	9,360.3	40.0
Primary fuel and lubricants	63.2	-36.5	7.5	0.0
Processed fuel and lubricants	-30.6	47.5	86.0	0.4
Spare parts and accessories for capital goods	-51.2	2.3	1,041.6	4.5
Spare parts and accessories for transportation equipment	-36.9	119.6	1,402.5	6.0
Others	49.6	31.8	8,056.1	34.4
Total	-0.6	20.6	23,391.8	100.0

was due to an increase in a 46.9% increase in the oil and gas services deficit and an 8.5% increase in the non-oil services deficit. The increase in the oil and gas services deficit was mainly due to a 49.0% increase in non-freight services, which rose to \$4.2 billion primarily because of higher payments on oil and gas production sharing contracts and higher oil prices. In non-

Table 5.5
Imports of Capital Goods

Item	1999*	2000	2000*	
	Growth (%)		Value (Millions of \$)	Share (%)
Tractor & agriculture equipments	-75.4	125.0	27.4	0.4
Handicraft and accessories	-60.4	-97.5	0.0	0.0
Container & storage box	-41.3	-37.7	25.1	0.4
Nuclear reactor & machinery	-45.0	10.0	2,346.0	36.0
Generator & electronics	-61.8	12.1	380.7	5.8
Locomotive, ship, & aircraft	2.2	36.6	1,000.3	15.4
Craftsmanship tools	-47.1	27.5	26.0	0.4
Optical & measurement devices	-32.4	59.5	400.6	6.2
Passenger cars	-69.2	601.2	64.7	1.0
Others	24.9	-4.7	2,243.2	34.4
Total	-25.7	10.6	6,514	100.0

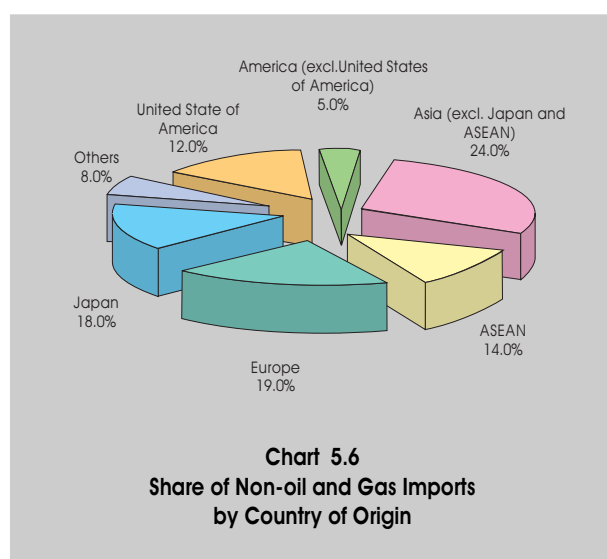

oil and gas services balance, non-freight services grew by 8.7% to \$10.1 billion due to an increase in government debt servicing costs and transportation services. The deficit in non-oil freight costs increased by 9.4% to \$2.6 billion along with the growth of non-oil imports.

On the revenue side of non-oil and gas services, the largest source of foreign exchange revenue was the tourism sector which produced \$4.8 billion revenue in 2000, \$0.4 billion more than in the previous year level. The number of foreign tourists visiting Indonesia increased from 4.5 million to 5.1 million in 2000. Most of the foreign tourists entered via three main arrival gateways including Denpasar, Batam, and Jakarta. The increase in the number of foreign tourists marked the recovery of Indonesia's tourism sector after a slump during the past three years.

Capital Account

The capital account recorded a deficit of \$4.6 billion in 2000, which was roughly the same as in the previous year. The deficit was due to a decline in net official capital flows and to net private capital outflows.

The surplus of net official capital flows in 2000 reached \$3.8 billion, down from a surplus of \$5.4 billion in the previous year. The decline in the surplus was caused by a 59.0% drop in foreign program aid, including assistance from the

ADB, the IBRD and Japan (JBIC), to \$1.6 billion. The drop in food aid by 73.0% to only \$73.0 million also contributed to the decline in the surplus. Meanwhile, project loans coming both from the CGI and from non-CGI sources rose by \$0.3 billion to \$2.7 billion. The increase was mainly due to a rise in ODA multilateral loans by \$0.5 billion to \$1.5 billion. Non-ODA loans in the reporting year fell by \$0.3 billion to \$0.4 billion.

The deficit in net private capital flows dropped by \$1.4 billion in 2000 to \$8.5 billion. The drop was linked to the increased private capital inflows, particularly for direct foreign investment, and to the reduced offshore debt payments from the banking sector.

Indonesia's total foreign debt stood at \$140.0 billion at the end of October 2000, down by 5.5% from \$148.1 billion at the end of 1999 (Table 5.6). Both private and foreign government debts declined. The decline in private foreign debt was mainly due to debt repayment by non-bank firms. Due to significant amount of government foreign debt denominated in Yen, the decline in government foreign debt was a result both of debt repayment and the weaker yen relative to the U.S. dollar.

Fifty-three percent of Indonesia's total foreign debt of \$140.0 billion, or \$74.8 billion, consisted of government debt. In terms of maturity, short-term debt maturing by October 2001 was estimated at \$29.0 billion, with \$3.4 billion out of this was

Table 5.6
Outstanding Foreign Debts

	1998	1999	2000			
			Mar.	Jun.	Sep.	Oct.
Millions of \$						
Government	67,315	75,862	75,292	76,487	75,405	74,800
Private :	83,572	72,235	68,991	67,678	65,396	65,197
Bank	10,769	10,836	10,379	10,314	9,385	7,975 ¹⁾
Non-Bank	67,515	58,243	55,309	54,917	53,714	55,027
Securities	5,288	3,156	3,303	2,447	2,297	2,195
Total	150,887	148,097	144,283	144,165	140,803	139,997

1) Excl. third party deposits.
(accord. to BI Circular No.2/20/DLN/2001)

government debt and \$25.6 billion was private sector debt. Of the total amount of short-term foreign debt, \$22.4 billion is debt that carried a maturity of more than one year in the original loan agreement but is maturing by October 2001, and the remaining \$6.7 billion is short-term debt with an original maturity of up to one year. Out of the \$25.6 billion short-term private sector debt, \$23.7 billion (92.7%) was owed by the non-bank private sector, and the remaining \$1.9 billion (7.3%) was owed by the banking sector (Table 5.7).

The financial service and leasing sector accounted for the largest part of this debt, with the foreign debt of this sector amounting to \$31.6 billion or 22.9% of Indonesia's total foreign debts. The next largest debtor was manufacturing, with \$31.3 billion in foreign debt (22.7% of the total) and electricity, gas and water with \$14.5 billion of foreign debt (10.5% of the total). Relative to the 1999 year-end position, there was a shift from manufacturing to the financial service and leasing sector.

Japan was the largest creditor of Indonesia, with total outstanding loans of \$46.7 billion or 33.3% of the Indonesia's total foreign debts, followed by the U.S. with \$8.1 billion (5.8% of the total), the Netherlands with \$13.0 billion (9.3% of the total), and Germany with \$8.0 billion (5.7% of the total). Multilateral Institutions such as the IBRD, the IMF and the ADB were the largest institutional lenders, with exposures of \$11.8 billion (8.4% of the total), \$10.7 billion (7.6% of the total), and \$7.5 billion (5.3% of the total), respectively. In terms of currency

denomination, Indonesia's foreign debt was mostly denominated in U.S. dollars, with U.S. dollar debt totaling \$89.2 billion or 63.7% of the total, followed by Japanese yen debt at \$30.6 billion or 21.8% of the total, SDR debt at \$10.8 billion or 7.7% of the total, and DEM debt at \$2.5 billion or 1.8% of the total.

Official debt maturing during the reporting year amounted to \$4.5 billion. Around \$2.0 billion was repaid, and another \$2.5 billion was rescheduled via Paris Club I and II. At the Paris Club II meeting on April 12-13, 2000, it was agreed to reschedule another \$5.8 billion in principal payments on debt maturing between April 1, 2000 and March 31, 2002. Based on the restructuring agreement, soft term ODA loans were rescheduled to 20 years, including a seven-year grace period and the interest rate applied to the soft term loan facility. The non-ODA bilateral loans were rescheduled to 15 years, including a three-year grace period with market interest rates. In addition, the amount of commercial debt restructured via the London Club framework totaled \$340 million, rescheduled to 12 years 6 months with a grace period of 3 years.

Efforts also continued to restructure private foreign debt during the reporting year. Private bank debt restructured through the Exchange Offer program reached \$6.3 billion, with \$3.0 billion of this debt restructured through Exchange Offer I and \$3.3 billion restructured through Exchange Offer II. Private non-bank debt restructured through the Jakarta Initiative Task Force between 1998 and 2000 amounted to \$9.4 billion, or 93.6% of the \$10 billion target, including both foreign and domestic debt.

The debt service ratio stood at 44.8% in 2000, the total debt to export ratio stood at 198.2%, and the total debt to GDP

Table 5.7
Foreign Debt by Maturity as of October 2000¹⁾

No.	Maturity	Government	Private			Investment Total
			Bank	Non-Bank		
Millions of \$						
1	Short-term ²⁾	3,420	1,877	12,068	11,636	29,001
	- Original Maturity	56	25	1,786	4,781	6,648
	- Remaining Maturity	3,364	1,852	10,282	6,855	22,353
2,	Medium & Long-term ³⁾	71,380	6,107	16,117	17,392	110,996
	Total	74,800	7,984	28,185	29,028	139,997

- 1) Including domestic securities
2) Up to 1 year
3) More than 1 year

Table 5.8
Foreign Debt Indicators

Indicator	1997	1998	1999	2000*
	In percent			
DSR	44.5	57.9	56.8	44.8
Outstanding debt/Exports	207.3	261.8	252.1	198.2
Outstanding debt/GDP	62.2	146.3	103.3	84.3

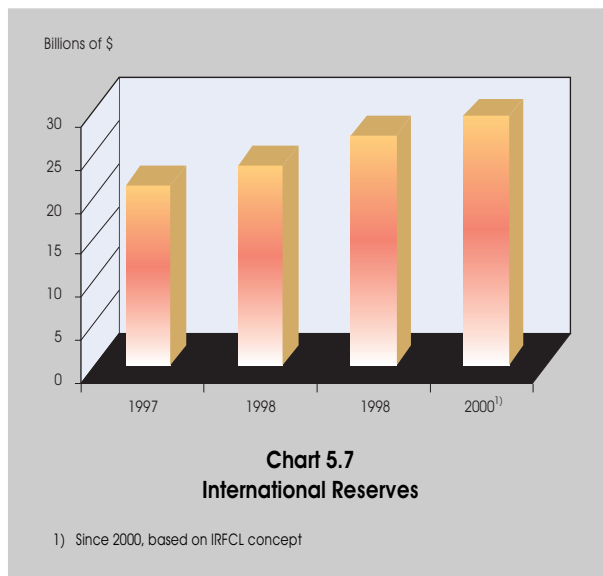

ratio stood at 84.3%. In 1999 these ratios stood at 56.8%, 252.1%, and 103.3% (Table 5.8). Despite this improvement relative to 1999, the high ratios reflect the huge debt burden and the high dependency of the country's economy on foreign debt.

International Reserves

With a \$5 billion balance of payment surplus, Indonesia's international reserves at the end of 2000 reached \$29.3 billion, equivalent to 6 months worth of imports plus official debt repayment. Since May 2000, the recording of Indonesia's international reserves has been based on the International Reserves and Foreign Currency Liquidity (IRFCL) standard in place of the Gross Foreign Assets standard (Box: New Concept of International Reserves).

Box : The New Concept of International Reserves

At the end of May 2000, in accordance with the agreement in Letter of Intent (LoI) dated January 20, 2000, Bank Indonesia started to announce international reserves figure based on the International Reserves and Foreign Currency Liquidity (IRFCL) concept in accordance with international reporting standards. The new concept replaced the old one, known as Gross Foreign Assets (GFA), which was introduced in January 1998. The IRFCL concept as well as the GFA concept are based on the fifth Balance of Payments Manual (BPM5) and the IMF's Special Data Dissemination Standards (SDDS).

According to BPM5, the primary reference for SDDS, international reserves (also called reserve assets or official reserve assets) must meet four major principles. **First**, international reserves must be liquid or readily available in the short term (one year) and controlled by the monetary authority (Bank Indonesia). **Second**, the concept of international reserves is not based on net concept but on gross concept. In other words, external liabilities of the monetary authority are not subtracted from international reserves. **Third**, foreign assets are monetary authority's claims on non-residents. **Fourth**, the type of reserve assets cover not only foreign exchange assets but also gold, special drawing rights (SDRs), reserve position in the IMF, and other claims.

In line with the change in international reserves concept, gross reserve calculation on Net International Reserves (NIR), which was first introduced in January 1998, was revised. The change includes regrouping on type of assets in accordance with the IRFCL concept, which includes only readily available assets. The assets that are no longer included as international reserves include export drafts and commemora-

Item	April 30, 2000 (millions of \$)	
	New Concept	Old Concept
I. International Reserves	26,941.2	29,477.8
a. Official Reserve Assets	26,941.2	28,443.8
b. Other Foreign Currency Assets	0.0	1,034.0
II. Gross Foreign Liabilities (IMF)	10,451.9	10,451.9
III. Reserve against Foreign Currency Deposits	755.2	755.2
IV. Net International Reserves	15,734.1	18,270.7

tive coins, among other items. With the revision, Indonesia's NIR position has changed, as shown in Table 1.

Despite having the same components as international reserves, gross reserves under the NIR concept use different exchange rate from that used in international reserves under the IRFCL concept. Calculation on gross reserves under the NIR concept uses constant exchange rate between USD and other foreign currencies, while calculation on international reserves under the IRFCL concept uses current (at the time reporting) exchange rate between USD and other foreign currencies.

The NIR figure, which has been converted into rupiah using constant Rp/USD exchange rate in accordance with the LoI, is published in Bank Indonesia weekly press release. In addition to NIR, press release also includes weekly international reserve (official reserve assets) figure. A comprehensive table of IRFCL (international reserves and other FCLs) is published routinely at the end of each month that consists of previous month data. The publication can be seen at the following website addresses: <http://www.imf.org/country/idn> and <http://www.sdds.or.id>.

Box : Monitoring of Foreign Exchange Activity through Banks and Non-Bank Financial Institutions

In an effort to create a foreign exchange activity monitoring system as stipulated by Act Number 24/1999 on Foreign Exchange Activities and the Exchange Rate System, in 1999 Bank Indonesia issued Bank Indonesia Regulation Number 1/9/DSM/PBI/1999 on the monitoring of foreign exchange activities of banks and non-bank financial institutions.

To implement the above regulation, Bank Indonesia through its circular Number 1/9/DSM dated December 28, 1999 on the reporting of foreign exchange activity by banks, required all commercial banks that carry out foreign exchange activities to report their foreign exchange activities to Bank Indonesia monthly. The stipulation was effective starting with foreign exchange activities made in March 2000, with the report to be submitted to Bank Indonesia in April 2000. The primary reason for placing a high priority on compelling banks to report their foreign exchange activities was because a large share of foreign exchange activities are made through banks. All banks that have foreign exchange activities have now report their activity to Bank Indonesia.

Considering that the foreign exchange activity monitoring system was newly implemented, there were several constraints encountered during its implementation, including preparing an internal online system for banks, a lack of understanding about the new reporting regulation, difficulties in obtaining data from customers especially for incoming transfers, and reporting requirements that had not yet been perfected. There was concern that these constraints could affect the accuracy of the report, so for the time being the data could not yet be published. To overcome these constraints, Bank Indonesia made various efforts including establishing a working group, which was a medium

for banks to discuss their problems related to the reporting of foreign exchange activities, creating a help desk, and providing feed back to the reporting banks. In addition, the regulation on the reporting of foreign exchange activities was improved with the issuance of Bank Indonesia Circular Number 2/28/DSM/ dated December 21, 2000 on the reporting of foreign exchange activities by banks. With these efforts, the foreign exchange activity monitoring system is expected to improve.

In the reporting year, Bank Indonesia also issued Circular Number 2/23/DSM dated November 10, 2000 on the reporting of foreign exchange activity of non-bank financial institutions, which was an extension of Bank Indonesia's Regulation Number 1/9/PBI/1999. This circular requires non-bank financial institutions making foreign exchange activities to submit a report to Bank Indonesia, which covers:

1. Foreign exchange activities not conducted through on-shore banks including activities made via overseas current account of the non-bank financial institutions, inter-company/office account, other forms of infrastructures on a monthly basis; and or
2. Claims and obligations position of non-bank financial institutions to non-residents at the end of a semester.

The requirement for non-bank financial institutions to report their foreign exchange activities was effective for transactions made in January 2001, with the first report to be submitted to Bank Indonesia in February 2001. With the implementation of the regulation requiring banks and non-bank financial institutions to report their foreign exchange activities, it is expected that a large part of foreign exchange activities made by residents are now covered.

Summary of Regulations Concerning the Foreign Exchange Activity Report of Banks and Non-Bank Financial Institutions

No.	Description	Regulation
1	Reporting non-bank financial institutions	All non-bank financial institutions incorporated in Indonesia as well as branches of foreign non-bank financial institutions operating in Indonesia.
2	Scope of report: – Transaction report – Position report – Correction report	Transactions (incoming and or payment) made not via on-shore banks. Initial position, flow during period, and end position. A replacement report to the first report which has been returned because of incompleteness or mistakes.
3.	Reporting period: – Transaction report – Position report	Monthly Semester
4.	Report submission period	Not later than the 15th of the following month of the end of the reporting period.
5.	Report submission mechanism	Letter or facsimile
6.	Penalty – Late report – Not submitting the report – Incomplete or incorrect report – Not submitting report successively for a 6-month period or as late as 6 months	Penalty of Rp 1 million per day Penalty of Rp 20 million plus late penalty Penalty of Rp 50,000 per incomplete or incorrect data with a maximum penalty of Rp 20 million. Can be recommended for termination of business license.

Chapter 6 *Government Finance*



Fiscal year 2000 marked a period of consolidation and transition towards a sounder and more sustainable fiscal position. There were some improvements during the year, such as the government's ability to generate more revenues from domestic sources, to prioritize expenditure, and to reduce reliance on foreign financing sources.

In general, the fiscal strategy set forth in the state budget for 2000 --which covered the nine month period from April 1, 2000 to December 31, 2000-- was aimed at achieving the following six objectives :

- i. Maintaining fiscal sustainability by reducing the ratio of the budget deficit to GDP and the ratio of foreign financing to GDP through increased domestic financing;
- ii. Providing a fiscal stimulus by prioritizing the state budget for the benefit of low income groups;
- iii. Supporting the bank restructuring program by allocating a proportion of the state budget for interest payments on domestic debt under the framework of the bank recapitalization program;
- iv. Reducing subsidies gradually for selected targets and subsidized items;
- v. Improving the welfare of civil servants;
- vi. Strengthening the foundation for the implementation of the decentralization program and regional autonomy.

Some objectives have been accomplished, including banking sector recapitalization, fuel subsidies reduction (although the reduction of the fuel subsidies was delayed from April until October 2000), raising the welfare of civil servants, the military and the police, and providing a legal basis for the implementation of regional autonomy and fiscal decentralization. Some other objectives, however, encountered difficulties during implementation and had to be postponed, such as the plan to impose the Value Added Tax (PPn) and the Luxurious Goods Tax (PPnBm) in the Batam Authority Area and to privatize certain state firms. Nevertheless, in general govern-

ment finance during fiscal year 2000 achieved, and in some cases exceeded, the targets that had been established.

Both government expenditures and revenue collection exceeded the targets that had been set at the beginning of the year. Revenue performance was particularly strong, mainly due to higher oil prices in the international market, which reached US\$29.1 per barrel during 2000 (Table 6.1), along with higher gas prices. Higher oil prices, however, also contributed to a rise in government expenditures on fuel subsidies, although the increase in subsidies was less than the additional revenue. Higher prices of oil and gas gave a significant boost to government tax revenues, especially from the oil and gas income tax. As a result, the ratio of taxes to GDP reached 11.8% in fiscal year 2000, which was higher than the 2000 state budget target of 11.1% (Table 6.2).

On the expenditure side, most government spending was allocated for non-discretionary purposes, consisting mainly of salaries for central government and regional civil servants, interest payments, and subsidies. Salary expenditures increased from the previous year in line with the government's policy of raising salaries for civil servants, the military and the police force by providing additional allowances of Rp64,750 per employee in April and Rp65,000 per employee in October 2000. Debt interest payments rose along with higher levels of government

Table 6.1
Basic Assumptions for the 2000 State Budget

Assumption	Budget	Realization ¹⁾
Nominal GDP (trillions of rupiah)	910.4	937.4
Economic growth (%)	3.8	4.5
Inflation rate (%)	4.8	7.0
Crude oil price (\$/barrel)	20.0	29.1
Oil production (millions of barrels/day)	1.46	1.41
Exchange rate (Rp/\$)	7,000	8,292

1) Provisional budget realization
Source : Ministry of Finance

domestic debt and the weakening of the rupiah exchange rate. Meanwhile, the higher allocation for subsidies was caused not only by high oil prices and exchange rate depreciation, but also by other factors, including the delay of the fuel price increase from April to October 2000 and higher oil imports due to problems at domestic oil refineries.

With respect to monetary developments, government financial operations during the first eight months of the reporting year contributed to a net contraction of the money supply owing to higher revenues --derived mostly from tax collec-

tions and asset sales of restructured banks-- than government spending in rupiah. The government's financial operations had a significant expansionary impact only in December 2000, after all subsidies and development expenditures had been realized.

With respect to the balance of payments, government financial operations resulted in significant net inflows from oil and gas revenues. Higher revenues from oil and gas reduced the need for foreign financing. Drawings on foreign loans reached only 72.0% of the target.

Table 6.2
Government Financial Operation

Item	1999/00 ¹⁾		2000				
			Budget ²⁾		Realization ³⁾		
	Trillions of Rp	% of GDP	Trillions of Rp	% of GDP	Trillions of Rp	% of GDP	% of Budget
A. Total Revenues and Grants	188.5	16.5	152.9	16.8	194.1	20.7	127.0
Oil & gas and Non-Oil & gas	188.5	16.5	152.9	16.8	194.1	20.7	127.0
Oil and gas	42.7	3.7	33.2	3.6	59.6	6.4	179.4
Tax	128.6	11.3	101.4	11.1	111.1	11.8	109.5
Non-tax revenues	17.2	1.5	18.2	2.0	23.5	2.5	128.7
B. Total Expenditures	206.4	18.1	197.0	21.6	223.9	23.9	113.6
Operational expenditures	155.1	13.6	156.1	17.2	182.4	19.5	116.8
Personnel expenditure	32.1	2.8	30.7	3.4	30.0	3.2	97.7
Material expenditure	10.0	0.9	9.4	1.0	9.0	1.0	95.8
Transfer to regional governments	17.3	1.5	18.1	2.0	17.6	1.9	97.1
Interest payments	42.8	3.8	54.6	6.0	53.3	5.7	97.6
– Domestic debt	22.2	1.9	38.0	4.2	34.8	3.7	91.5
– Foreign debt	20.6	1.8	16.6	1.8	18.6	2.0	
Subsidies	47.0	4.1	30.8	3.4	59.7	6.4	193.7
– Fuel subsidy	35.8	3.1	22.5	2.5	51.1	5.5	227.7
– Non-fuel subsidy	11.2	1.0	8.4	0.9	8.6	0.9	102.7
Other current expenditures	5.8	0.5	12.5	1.4	12.7	1.4	102.0
Development expenditures and net lending	51.3	4.5	40.9	4.5	41.5	4.4	101.5
– Rupiah financing	28.1	2.5	24.9	2.7	24.9	2.7	100.2
– Project aid	23.2	2.0	16.0	1.8	16.6	1.8	103.6
C. Statistical Discrepancy	0.2	0.0	0.0	0.0	0.0	0.0	–
D. Primary Balance	25.1	2.2	10.5	1.2	23.6	2.5	224.7
E. Overall Balance	(17.7)	(1.6)	(44.1)	(4.8)	(29.8)	(3.2)	67.4
Financing	17.7	1.6	44.1	4.8	29.8	3.2	67.4
A. Domestic bank	(14.8)	(1.3)	–	–	(0.8)	(0.1)	–
B. Domestic non-bank	16.6	1.5	25.4	2.8	18.9	2.0	74.4
– Privatization proceeds	3.7	0.3	6.5	0.7	–	–	–
– Asset recovery, gross	12.9	1.1	18.9	2.1	18.9	2.0	100.0
– Bond issuing	–	–	–	–	–	–	–
C. Foreign financing, net	15.9	1.4	18.7	2.1	11.6	1.2	62.0
– Gross drawing	36.2	3.2	27.3	3.0	19.7	2.1	72.0
– Amortization	(20.3)	(1.8)	(8.6)	(0.9)	(8.1)	(0.9)	93.8

1) Realization up to March 31, 2000

2) State budget approved on March 2, 2000

3) Provisional budget realization

Sources : Ministry of Finance (processed) and Bank Indonesia

Revenue¹⁾

Total revenues and grants during fiscal year 2000 reached Rp 194.1 billion, or 27.0% above the target. The largest contributor was tax proceeds, which accounted for 57.2% of total revenues and grants and exceeded the target by 9.5%. Most tax categories exceeded their targets, except for non-oil and gas income tax, "other" taxes and export taxes. The second largest contributor was oil and gas, accounting for 30.7% of total revenues and grants and exceeding the target by 79.4%. The remaining revenue was from the non-tax revenue category which exceeded the target by 28.7%.

On an individual component basis for the three largest revenue contributors, oil and gas was the largest contributor, accounted for 30.7% of total revenues and grants, followed by income tax at 29.7% and value added tax at 16.2%. Oil and gas income tax constituted 9.0% of total revenues and non-oil and gas income tax accounted for 20.7% of total revenues (Chart 6.1). Oil and gas revenue exceeded the state budget target by 79.4%, followed by value added tax (16.7% over target) and income tax (6.3% over target) (Chart 6.2).

In the income tax category, realized non-oil and gas income tax reached only 90.8% of the target, while oil and gas income tax reached 174.1% of the target, thus reflecting the significant contribution of oil and gas to the overall income tax target. The shortfall of non-oil and gas income tax relative to the target in the state budget was attributed to lower interest rates and to the policy of granting tax exemptions to integrated development zones (KAPET).

Two other tax categories with achievements below target were the "other" tax category and export taxes. These two categories represent only a small share of total revenues. "Other" tax proceeds are mainly from stamp duty charges. Although revenue from this category almost doubled from the previous year, it remained lower than expected due to rela-

1) Estimated figures for April to December 2000, from Note of Government Budget and Draft on the Amendment of Act Number 2 Year 2000 on Government Budget for Fiscal Year 2000

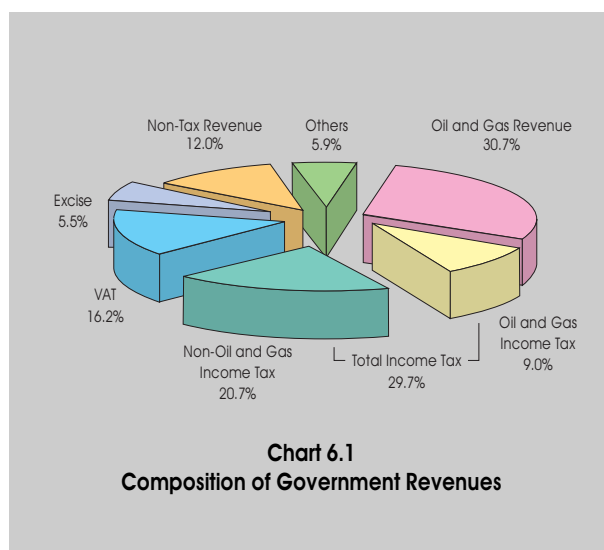

tively low usage of stamp duty in business transactions.²⁾ The low achievement in export tax proceeds was due to reduction of export tax rates to encourage certain export commodities, such as palm oil and its derivatives.³⁾

Expenditure

Total government expenditures in the 2000 state budget reached Rp223.9 trillion, exceeding the state budget target by 13.6%. As planned, operational expenditure dominated total expenditures, accounting for 81.5% of state budget spending. Operational spending exceeded the budget target by 16.8%. The remaining 18.5% of state budget expenditure was for development programs. Realized spending on these programs exceeded the target by 1.5%. Higher-than-expected operational expenditure was mainly due to fuel subsidies, which were more than twice the amount targeted in the state budget. Higher fuel subsidies were due to high oil prices, the depreciation of the rupiah, increased oil imports due to domestic oil refinery problems, and the delay of the fuel price increase that was scheduled to be implemented in early April 2000.

2) Efforts to reach the target were carried out through the issuance of Government Regulation Number 24 dated on April 20, 2000 on The Revision of Stamp Duty Charges and the Amount of Nominal Value Applicable for Stamp Duty Charges.

3) Ministry of Finance Decree Number 387 dated on September 12, 2000 on palm oil export tax, CPO, and the derivative.

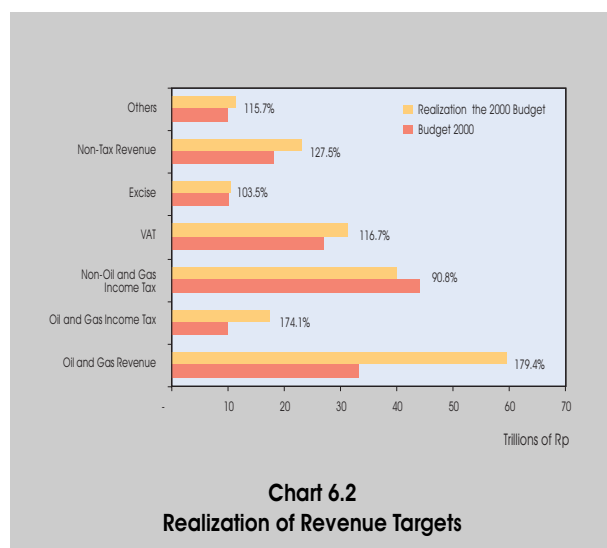

Chart 6.2
Realization of Revenue Targets

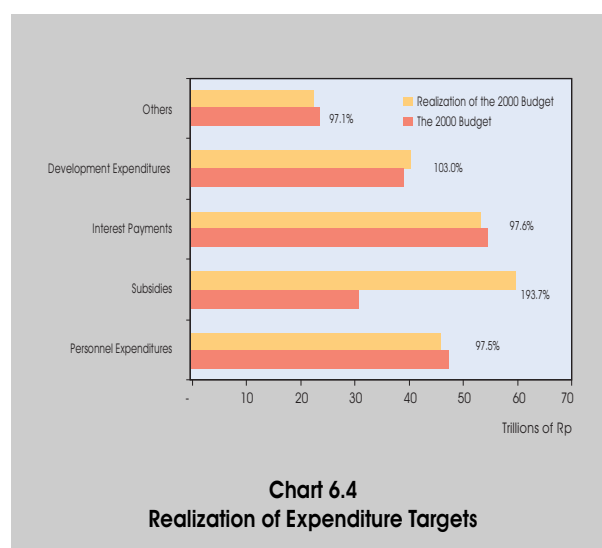

Chart 6.4
Realization of Expenditure Targets

The largest expenditure category was subsidies, which accounted for 26.7% of total expenditures, followed by domestic and foreign debt interest payments (23.8%) and personnel expenditures for central government and regional civil servants (21.3%) (Chart 6.3). Realized expenditure for all major categories fell between 97.0% and 103.0% of the target for each category, with the exception of subsidies which far exceeded the target by 93.7% (Chart 6.4). Higher allocations for subsidies caused the ratio of non-discretionary spending to GDP to rise from 12.2% in fiscal year 1999/2000 to 17.1% in fiscal year 2000.

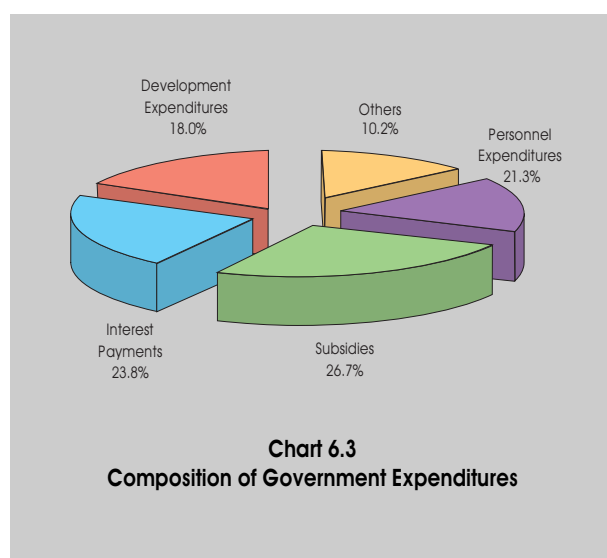

Chart 6.3
Composition of Government Expenditures

Financing

With realized government revenues exceeding the initial budget target by more than realized government expenditures, the fiscal year 2000 government budget was expected to record a deficit of Rp29.8 trillion or 3.2% of GDP, less than the budgeted deficit of Rp44.1 trillion or 4.8% of GDP (Table 6.2). The deficit was financed by two sources, asset sales from banks under the restructuring program (61.9%) and net foreign debt (38.1%). Privatization of state-owned companies has yet to make any contribution to the state budget. With financing sources exceeding the realized deficit, government finance registered a surplus of Rp0.8 trillion or 0.1% of GDP, adding to the government account in the monetary system.

Asset sales under the bank restructuring program exactly matched the target in the state budget while foreign debt drawings reached only 62.0% of the target. Privatization of state firms failed to contribute to the budget for three reasons: (i) the domestic and international capital markets were not favorable for IPOs (Initial Public Offerings), (ii) high country risk, and (iii) state firms to be privatized had not completed the restructuring process.

Based on these financing developments, the ratio of domestic financing to GDP was recorded at 2.0%, slightly above the previous year ratio of 1.5% of GDP (Table 6.3), while the foreign debt to GDP ratio remained at 49.9% despite net drawings during 2000. Total

Table 6.3
Selected Ratios

Item	1998/99 ^{a)}	1999/00 ^{b)}	2000	
			Budget ^{c)}	Realization ^{d)}
			In percent	
1. Tax Ratio	10.7	11.3	11.1	11.8
2. Tax ratio exclude oil and gas income tax	9.7	9.9	10.0	10.0
3. Domestic taxes ¹⁾ /total taxes	84.3	83.8	84.3	78.5
Domestic taxes ¹⁾ /GDP	9.1	9.5	9.4	9.3
4. International trade taxes ²⁾ / total taxes	15.7	16.2	15.7	21.5
International trade taxes ²⁾ / GDP	1.7	1.8	1.8	2.6
5. Buoyancy ³⁾	0.8	1.64	n.a.	1.58
6. Oil and gas revenues/total revenues	19.5	22.7	21.7	30.7
Oil and gas revenues/GDP	2.9	3.7	3.6	6.4
7. Government consumption/GDP	4.6	5.6	7.6	7.2
8. Gross domestic capital formation/GDP	5.1	4.5	4.5	4.4
9. Transfer payments ⁴⁾ /GDP	3.4	6.1	7.6	10.1
10. Non-discretionary expenditures ⁵⁾ /GDP	10.0	12.2	14.7	17.1
11. Non-discretionary expenditures ⁵⁾ /total taxes	92.7	108.3	132.3	144.6
12. Surplus (+)/Deficit (-) /GDP	-1.5	-1.6	-4.8	-3.2
13. Surplus (+)/Deficit (-) exclude interest payments/GDP	1.6	2.2	1.2	2.5
14. Public debt outstanding ⁶⁾ /GDP	93.4	100.5	-	106.9
15. Government debt outstanding/GDP	85.0	94.2	-	100.7
16. Government foreign debt outstanding /GDP	64.0	49.9	-	49.9
17. Government domestic debt outstanding ⁷⁾ /GDP	20.9	44.3	-	50.8
18. Domestic financing ⁸⁾ /GDP	0.2	1.5	2.8	2.0

Notes :

1) Total tax revenues minus international trade tax revenue
2) Oil and gas income tax, import duties and export tax
3) Calculated by using the formula growth of total tax revenues divided over growth of GDP
4) Subsidies and domestic interest payment
5) Personnel expenditure, transfer to regional governments, interest payments, and subsidies
6) Government foreign debt, state-owned enterprises, state banks and government domestic debt
7) Government bonds issued for bank restructuring, BI's liquidity support and blanket guarantee
8) Privatization proceeds of state-owned enterprises and asset recovery

a) Audited realization (PAN)
b) Realization up to March 31, 2000
c) State budget approved on March 2, 2000
d) Provisional budget realization

Sources : Ministry of Finance (processed) and Bank Indonesia

government debt rose to 100.7% of GDP due to the increase in domestic debt issued for the bank recapitalization program.

Monetary and Aggregate Demand Impact of Government Financial Operations

In the year 2000, the government spent Rp223.9 trillion, out of which 48.8% or Rp109.3 trillion had a direct impact on aggregate demand through government consumption and investment, while the other 42.2% or Rp94.5 trillion consisted of transfers to the private sector in the form of subsidies and domestic debt interest payments. Of government spending with a direct impact on aggregate demand, Rp67.8 trillion or 62.0% was government consumption whereas the remaining Rp41.5 trillion or 38.0% was government investment (Table 6.4).

With respect to monetary developments, government financial transactions during the 2000 fiscal year contributed to a net rupiah expansion of Rp39.8 trillion (Table 6.5). Mon-

etary expansion was caused mainly by subsidy payments, personnel expenditure, and interest payments on government domestic bonds. Monetary contraction was caused by inflows

Table 6.4
Impact of State Budget on Domestic Demand

Item	1999/00 ¹⁾		2000			
			Budget ²⁾		Realization ³⁾	
	Trillion of Rp	% of GDP	Trillion of Rp	% of GDP	Trillion of Rp	% of GDP
A. Government Consumptions	64.4	5.6	69.1	7.6	67.8	7.2
Domestic personnel expenditures	31.5	2.8	29.9	3.3	29.2	3.1
Domestic material expenditures	9.8	0.9	8.7	1.0	8.3	0.9
Transfer to regions	17.3	1.5	18.1	2.0	17.6	1.9
Other current expenditures	5.8	0.5	12.5	1.4	12.7	1.4
B. Gross Domestic Fixed Capital Formation	51.3	4.5	40.9	4.5	41.5	4.4
Rupiah financing	28.1	2.5	24.9	2.7	24.9	2.7
Project aid	23.2	2.0	16.0	1.8	16.6	1.8
C. Total A + B	115.7	10.1	110.0	12.1	109.3	11.7

1) Realization up to March 31, 2000
2) State budget approved on March 2, 2000
3) Provisional budget realization

Sources : Ministry of Finance (processed) and Bank Indonesia

Table 6.5
Rupiah Impact of Government Financial Operation

Item	1999/00 ¹⁾		2000			
			Budget ²⁾		Realization ³⁾	
	Trillions of Rp	% of GDP	Trillions of Rp	% of GDP	Trillions of Rp	% of GDP
A. Revenues In Rupiah						
Oil and gas income tax	15.8	1.4	10.0	1.1	17.5	1.9
Non-oil & gas income tax and non tax revenue	129.9	11.4	109.6	12.0	116.8	12.5
Privatization proceeds	3.7	0.3	6.5	0.7	0.0	0.0
Asset recovery	12.9	1.1	18.9	2.1	18.9	2.0
Total revenues	162.3	14.2	145.1	15.9	153.2	16.3
B. Expenditures In Rupiah						
Operational	-133.7	-11.7	-138.0	-15.2	-162.3	-17.3
Personnel and transfer to region	-48.8	-4.3	-48.0	-5.3	-46.8	-5.0
Subsidies	-47.0	-4.1	-30.8	-3.4	-59.7	-6.4
Domestic interest payment	-22.2	-1.9	-38.0	-4.2	-34.8	-3.7
Other routine expenditure	-15.6	-1.4	-21.1	-2.3	-21.0	-2.2
Investment	-36.2	-3.2	-30.5	-3.3	-30.7	-3.3
Total expenditures	-169.9	-14.9	-168.4	-18.5	-193.0	-20.6
C. Statistical Discrepancy	0.2	0.0	0.0	0.0	0.0	0.0
D. Rupiah Impact (A-B+C)⁴⁾	-7.3	-0.6	-23.4	-2.6	-39.8	-4.2

1) Realization up to March 31, 2000

2) State budget approved on March 2, 2000

3) Provisional budget realization

4) Negative sign (-) means expansion, positive (+) means contraction

Sources : Ministry of Finance (processed) and Bank Indonesia

from taxes and from asset sales under the bank restructuring program.

With respect to the balance of payments impact of government financial activity, foreign exchange inflows from oil and gas and from foreign loans exceeded foreign debt service payments and imports under project-aid, resulting in net capital inflows that increased foreign exchange reserves in the monetary system by Rp40.6 trillion (Table 6.6). The largest source of foreign exchange inflow was oil and gas revenue, which exceeded inflows from foreign loans. Foreign loan drawings consisted mainly of project loans, while program loans were relatively small (Chart 6.5).

The State Budget for 2001

The state budget for 2001 is of strategic importance in the management of state finances because in addition to constituting the first Annual Development Plan (Repeta) under the

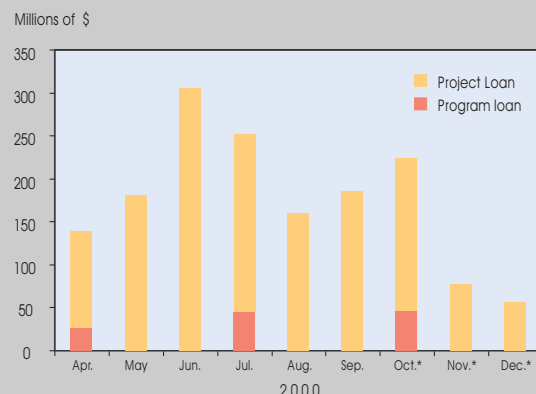

Source : Bank Indonesia

Grafik 6.5
Drawing of Official External Debt

National Development Program (Propenas), it also marks the first year of the implementation of regional autonomy and fiscal decentralization (Table 6.7).

The general strategy for fiscal policy in 2001 includes :

- Optimizing income from domestic sources including both tax and non-tax revenue;

Table 6.6
Foreign Exchange Impact of Government Financial Operation

Item	1999/00 ¹⁾		2000			
			Budget ²⁾		Realization ³⁾	
	Trillions of Rp	% of GDP	Trillions of Rp	% of GDP	Trillions of Rp	% of GDP
A. Current Account	6.2	0.5	4.6	0.5	28.8	3.1
Trade balance	27.4	2.4	22.0	2.4	48.1	5.1
Oil and gas export	42.7	3.7	33.2	3.6	59.6	6.4
Project aid import	-15.1	-1.3	-10.4	-1.1	-10.8	-1.2
Material expenditure	-0.2	0.0	-0.8	-0.1	-0.7	-0.1
Service account	-21.3	-1.9	-17.4	-1.9	-19.4	-2.1
Foreign debt interest payment	-20.6	-1.8	-16.6	-1.8	-18.6	-2.0
Personnel expenditure	-0.6	-0.1	-0.8	-0.1	-0.8	-0.1
B. Net Official Capital Inflows	16.0	1.4	18.7	2.1	11.8	1.3
Foreign debt disbursement	36.3	3.2	27.3	3.0	19.9	2.1
Foreign debt amortization	-20.3	-1.8	-8.6	-0.9	-8.1	-0.9
C. Forex impact (A+B)⁴⁾	22.2	1.9	23.4	2.6	40.6	4.3

1) Realization up to March 31, 2000

2) State budget approved on March 2, 2000

3) Provisional budget realization

4) Negative sign (-) means outflows, positive (+) means inflows

Sources : Ministry of Finance (processed) and Bank Indonesia

Table 6.7
Basic Assumptions for the 2001 State Budget

Assumption	Budget 2000 ¹⁾	Budget 2001
Nominal GDP (trillions of rupiah)	910.4	1.425.0
Economic growth (%)	3.8	5.0
Inflation rate (%)	4.8	7.2
Crude oil price (\$/barrel)	20.0	24.0
Oil production (millions of barrels/day)	1.46	1.46
Exchange rate (Rp/\$)	7,000	7,800

1) Period: April to December
Source: Ministry of Finance

- ii. Controlling and improving efficiency of government expenditures;
- iii. Reducing subsidies;
- iv. Distributing regional balancing funds;
- v. Reducing reliance on foreign sources of financing.

Government financial operations in 2001 are projected to record a deficit of Rp52.5 trillion or 3.7% of GDP, a decrease in percentage terms from the projected deficit for the year 2000 of Rp44.1 trillion or 4.8% of GDP (Table 6.8). Deficit reduction will be accomplished by raising government revenues, especially through higher tax collections relative to the previous year (reflected by a rise in the tax ratio from 11.1% to 12.6% of GDP) and by simultaneously promoting efficiency on the expenditure side. The deficit will be financed mostly from domestic sources (2.4% of GDP), including proceeds from privatization and asset sales under the bank restructuring program. Drawings on foreign loans will cover the remainder of the deficit (1.3% of GDP).

Government efforts to boost revenue from both tax and non-tax sources are projected to have a sizeable contractionary impact on the money supply. Nevertheless, the government's financial operations will still have an expansionary impact on the money supply (Table 6.9) due to an increase in total rupiah expenditures from 18.5% of GDP to 19.4% of GDP. Most of these rupiah expenditures (82.6%) are unavoidable, such as central government salary expenditures, subsidies, interest payments on domestic debt, and funds allocated for the implementation of regional autonomy. Overall, the 2001 state budget is expected to have a net expansionary impact on the money supply equal to 2.7% of GDP.

Table 6.8
Government Financial Operation for the 2000 and 2001 Budget

Item	Budget 2000 ¹⁾		Budget 2001 ²⁾	
	Trillions of Rp	% of GDP	Trillions of Rp	% of GDP
A. Government Revenues and Grants	152.9	16.8	263.2	18.5
I. Domestic Revenues	152.9	16.8	263.2	18.5
1. Tax revenues	101.4	11.1	179.9	12.6
a. Domestic taxes	95.5	10.5	169.5	11.9
i. Income tax	54.2	6.0	96.3	6.8
1. Oil and gas	10.0	1.1	20.8	1.5
2. Non-oil and gas	44.2	4.9	75.5	5.3
ii. Value added tax	27.0	3.0	48.9	3.4
iii. Excises	10.3	1.1	17.1	1.2
iv. Other taxes	4.0	0.4	7.3	0.5
b. International trade tax	5.9	0.6	10.4	0.7
2. Non-tax revenues	51.5	5.7	83.3	5.8
a. Natural resource revenues	40.1	4.4	64.5	4.5
i. Oil and gas	33.2	3.6	59.7	4.2
ii. Non-oil and gas	6.9	0.8	4.7	0.3
b. Profit transfer from SOEs	5.3	0.6	10.5	0.7
c. Other non-tax revenues	6.1	0.7	8.4	0.6
II. Grants	0.0	0.0	0.0	0.0
B. Expenditures	197.0	21.6	315.8	22.2
I. Central Government Expenditures	163.5	18.0	234.1	16.4
1. Current expenditures	137.3	15.1	190.1	13.3
a. Personnel	30.7	3.4	40.0	2.8
b. Material	9.4	1.0	9.7	0.7
c. Interest payments	54.6	6.0	76.5	5.4
i. Domestic debt	38.0	4.2	53.5	3.8
ii. Foreign debt	16.6	1.8	23.1	1.6
d. Subsidies	30.8	3.4	54.0	3.8
i. Fuel subsidy	22.5	2.5	41.3	2.9
ii. Non-fuel subsidy	8.4	0.9	12.6	0.9
e. Other current expenditures	11.7	1.3	9.9	0.7
2. Development expenditures	26.2	2.9	44.0	3.1
a. Rupiah financing	10.2	1.1	21.7	1.5
b. Project financing	16.0	1.8	22.3	1.6
II. Regional balancing funds	33.5	3.7	81.7	5.7
C. Statistical Discrepancy	0.0	0.0	0.0	0.0
D. Primary Balance	10.5	1.2	24.0	1.7
E. Overall Balance	(44.1)	(4.8)	(52.5)	(3.7)
F. Financing	44.1	4.8	52.5	3.7
I. Domestic Financing	25.4	2.8	33.5	2.4
1. Domestic bank financing	0.0	0.0	0.0	0.0
a. Financing surplus	0.0	0.0	0.0	0.0
b. Loan from banking sector	0.0	0.0	0.0	0.0
2. Domestic non-bank financing	25.4	2.8	33.5	2.4
a. Privatization proceeds	6.5	0.7	6.5	0.5
b. Asset recovery, gross	18.9	2.1	27.0	1.9
II. Foreign Financing	18.7	2.1	19.0	1.3
1. Gross drawing	27.3	3.0	36.0	2.5
a. Program loan	11.3	1.2	13.7	1.0
b. Project loan	16.0	1.8	22.3	1.6
2. Amortization	(8.6)	(0.9)	(17.0)	(1.2)

1) State budget approved on March 2, 2000

2) State budget approved on December 5, 2000
Source: Ministry of Finance (processed)

Table 6.9
Rupiah Impact of the 2000 and 2001 Budget

Item	Budget 2000 ¹⁾		APBN 2001 ²⁾	
	Trillions of Rp	% of GDP	Trillions of Rp	% of GDP
A. Revenues In Rupiah				
Oil and gas	10.0	1.1	20.8	1.5
Non-oil and gas	109.6	12.0	182.7	12.8
Privatization proceeds	6.5	0.7	6.5	0.5
Asset recovery	18.9	2.1	27.0	1.9
Total revenues	145.1	15.9	237.0	16.6
B. Expenditures In Rupiah				
Operational	-119.8	-13.2	-164.8	-11.6
Personnel expenditure	-29.9	-3.3	-38.7	-2.7
Subsidies	-30.8	-3.4	-54.0	-3.8
Domestic interest payment	-38.0	-4.2	-53.5	-3.8
Other routine expenditure	-20.4	-2.2	-18.7	-1.3
Investment	-15.8	-1.7	-29.5	-2.1
Regional balancing funds	-33.5	-3.7	-81.7	-5.7
Total expenditures	-168.4	-18.5	-276.0	-19.4
C. Statistical Discrepancy	0.0	0.0	0.0	0.0
D. Rupiah Impact (A-B+C)	-23.4	-2.6	-39.0	-2.7

1) State budget approved on March 2, 2000
2) State budget approved on December 5, 2000
Source : Ministry of Finance (processed)

The net expansionary impact of the government's financial operations will have implications for monetary policy. In principle, excess money resulting from fiscal expansion must be absorbed to control base money and to suppress inflationary pressures. For this reason, open market operations will be used as the main monetary instrument to absorb excess liquidity. However, under certain circumstances, Bank Indonesia could sterilize the impact of fiscal expansion through the foreign exchange market. This option is supported by potential net inflows of government foreign exchange proceeds deposited by the government with Bank Indonesia, coming mostly from oil and gas revenue and foreign loans, which are projected to reach 4.2% and 1.3% of GDP, respectively (Table 6.10). Drawings on foreign loans will be less in 2001 than in 2000, in line with the government's effort to reduce the foreign debt burden over the next few years.

With respect to the real sector, the contribution of the government's financial operations to the formation of aggregate demand is projected to reach 12.8% of nominal GDP, slightly more than last year when this contribution reached 12.1% of GDP (Table 6.11). As a percentage of GDP, budget allocations for several government consumption categories are

Table 6.10
Foreign Exchange Impact of the 2000 and 2001 Budget

Item	Budget 2000 ¹⁾		Budget 2001 ²⁾	
	Trillions of Rp	% of GDP	Trillions of Rp	% of GDP
A. Current Account	4.6	0.5	20.0	1.4
Trade balance	22.0	2.4	44.3	3.1
Oil and gas export	33.2	3.6	59.7	4.2
Project aid import	-10.4	-1.1	-14.5	-1.0
Others	-0.8	-0.1	-1.0	-0.1
Services account	-17.4	-1.9	-24.3	-1.7
Foreign debt interest payment	-16.6	-1.8	-23.1	-1.6
Others	-0.8	-0.1	-1.2	-0.1
B. Net Official Capital Inflows	18.7	2.1	19.0	1.3
Foreign debt disbursement	27.3	3.0	36.0	2.5
Foreign debt amortization	-8.6	-0.9	-17.0	-1.2
C. Foreign Exchange Impact (A+B)	23.4	2.6	39.0	2.7

1) State budget approved on March 2, 2000
2) State budget approved on December 5, 2000
Source : Ministry of Finance (processed)

expected to decline mainly due to the transfer of authority from the central government to regional governments (Box : Regional Autonomy and Its Implication Over The Monetary Control). For regional balancing funds in particular, almost the entire amount (99.0%) is in the form of block grants, over which the regional governments have full authority. Meanwhile, the government will play a role in raising private sector consumption through transfer payments, in the form of subsidies and interest on domestic debt amounting to 7.6% of GDP.

Table 6.11
Impact of the 2000 and 2001 Budget on Domestic Demand

Item	Budget 2000 ¹⁾		Budget 2001 ²⁾	
	Trillions of Rp	% of PDB	Trillions of Rp	% of PDB
I. Government Consumption	69.1	7.6	96.3	6.8
Domestic personnel expenditures	29.9	3.3	38.7	2.7
Domestic material expenditures	8.7	1.0	8.7	0.6
Transfer to regional government	18.1	2.0	38.9	2.7
Other current expenditures	12.5	1.4	9.9	0.7
II. Gross Domestic Fixed Capital Formation	40.9	4.5	86.8	6.1
Rupiah financing	24.9	2.7	64.5	4.5
Project aid	16.0	1.8	22.3	1.6
III. Total I + II	110.0	12.1	183.1	12.8

1) State budget approved on March 2, 2000
2) State budget approved on December 5, 2000
Source : Ministry of Finance (processed)

Box : Regional Autonomy and Its Implication Over The Monetary Control

As amended on the TAP MPR Number IV of 2000, regional autonomy will be implemented at the beginning of January 2001. The regional autonomy implementation is based on Act Number 22 of 1999 about Regional Authority and Act Number 25 of 1999 about Central Government and Regional Financial Balancing and other regulation on authority delegation from central government to regional authority and other financial sources grant. Along with the two regulations, regional authority is expected to be able to develop all the economic potential in its region in order to activate regional economy. However, fiscal capacity and fiscal needs may give a trouble to the successful regional autonomy implementation.

Authority and task delegation to the regional authority has a lot of impact to its structure revenues and expenditures. The World Bank study reported that regional spending would increased by 50% from the previous condition, bringing higher regional authority spending to the overall government spending by 40%. As a consequence, regional income would necessarily increased in a reasonable amount.

In order to anticipate such situation, Act Number 25 of 1999 has set regional income sources such as real regional revenues, regional balancing fund, regional debt, and other legal revenues. Other regulation to increased real regional revenues was revision of Act Number 18 of 1997 that control tax and retribution. The revised regulation has given large authority to the regional authority in collecting potential tax owned. On the other hands, the revised regulation impact to the real regional revenues –in short-term period– is expected not to be too significant, due to relatively small tax and retribution that can be collected, and definitely need study and evaluation on the fair tax and retribution collected. As a result, regional balancing fund has a very importance role as the main regional revenues in a short-term period.

On the central government side, local government dependency on Regional Balancing Fund –Revenue Sharing Fund, General Allocation Fund, and Special Allocation Fund– is facing a fund distribution burden, which was expected to support the operational services to the people. Revenue Shar-

ing Fund as considerably local revenues portion from land and building tax, land and building rights duty, and natural resources revenues, would only favored to those who have larger natural resources potential to increase the inter-regional income disparities. The disproportion distribution would cause a fiscal gap on the function and task delegation. To minimize the negative impact, Act Number 25 of 1999 has regulate allocation of at least 25% of the domestic revenues under the state budget in the form of General Allocation Fund. Other problem emerged was how to create the best formula in allocating General Allocation Fund to the region in such complicated economic potential and large necessitate.

Inevitably, there is no certain guarantee to avoid fiscal gap in such area and between regions by using Revenue Sharing Fund and General Allocation Fund distribution. In order to cover such fiscal gap, local authority may deliberately search for local financing under Act Number 25 of 1999 such as loan to the central government. Local financing to the central government can potentially increase the state budget deficit, which in turn can endanger fiscal sustainability. To avoid such unfavorable affect, both central government and local authority have to implement fiscal policy wisely so that the stimulus fiscal function over government spending can be actualized efficiently.

Those regional autonomy dilemmas may create two monetary implications. First of all, how the regional autonomy affect the inflation. Second of all, how the fund allocation and authority management would technically affect monetary policy management.

Based on the first aspect, the fiscal adjustment effort, in both revenues and expenditures, by the local authority could significantly affect the inflation rate. Fiscal adjustment composition which consisting increased local tax –in an effort to increase real local revenues– with expenditure composition dominated by non-discretionary spending –mostly coming from non-investment expenditures– would increased pressure on inflation rate. On the other hands, fiscal adjustment through efficiency on the local government routine expenditures with-

out reducing investment charges and without increasing tax excessively would reduce inflation rate pressure. Therefore, extravagance local authority tax and government spending allocation in such activities, which can push up the inflation, should be avoided.

Looking at the second aspect, monetary aspect on the regional autonomy implementation would be very much relevant with such huge fund allocated for the region. Regional fund distribution contains a potential of over-liquidity –which could cause exchange rate instability– if the regional fund distributed by the central government have not been used timely for financing the local authority expenditure. Furthermore, the change of fiscal spending behavior would possibly increase the monetary control operation complexity on inaccurate government spending mechanism as one of the liquidity calculation component.

Other issue to put under concern is the possibility of local government to search for other financing sources when they experience a deficit account. In the case that the local government managed its domestic financing inappropriately, such local debt could create crowding out situation due to

reduced private sector credit allocation, which in turn may increase interest rate and reduce investment. In the mean time, in the case of foreign financing, the date line would pressurize the balance of payment, which in turn could put the exchange rate under pressure. Both problems could also put pressure on the inflation.

In order to minimize such negative impact on the regional autonomy implementation to the monetary control operation, good coordination between the Central Bank and government, central government and local authority, need to be work. Especially in distributing actual revenues and expenditures data accurately and timely; by weekly, monthly and yearly projection (good financial programming). An accurate data would be a big help in evaluating and projecting liquidity precisely to the Central Bank, so that would improve monetary control operation. Furthermore, local government should consider in opening account in the Central Bank offices as a regional treasury. By utilizing the Central Bank offices as a regional treasury, negative monetary impact on the regional autonomy implementation could be minimized and detected earlier.

Chapter 7 *Banks and Other Financial Institutions*



Banks and other financial institutions demonstrated significantly improved performance during the year 2000, following positive developments in the Indonesian economy and the comprehensive bank-restructuring process initiated by Bank Indonesia and the Government of Indonesia. Reflecting the stronger performance was increased mobilization of funds, fresh lending even though at relatively low levels, increased capital and profitability, and reduction of non-performing loans. In a similar vein, multifinance companies posted improved results, reflected in the increased sources of funds and business activities reported in their financial statements. While bank lending remained at comparatively low levels during the reporting year, the state-owned pawn company seized the opportunity for substantial expansion of its lending activities.

Despite this, the intermediary function of banks and other financial institutions has yet to return to normal levels essential to economic recovery. This can be explained by a range of problems besetting both the real sector and the banking industry itself, while risks remain high and political and security conditions in Indonesia fraught with uncertainty. The slow progress in debt and corporate restructuring is hampering recovery in the real sector for the reason that most companies that are still undergoing restructuring represent the largest components of the Indonesian economy. For the banking sector itself, the ongoing difficulties in reviving the intermediary function were closely linked to the prevailing uncertainties of the volatile socio-political situation while banks were still undergoing internal restructuring to bring themselves into compliance with new prudential regulations. As a result, lending remained far below optimum levels, despite growth in the second half of 2000. Due to the surplus liquidity in the banking system, banks placed more of their depositor funds in Bank Indonesia Certificates (SBIs) and interbank lending.

Banking Sector

During 2000, banking policy remained firmly focused on accelerating the completion of bank-restructuring. While the government extended the term of its blanket guarantee scheme, bank-restructuring made significant strides with the completion of the bank recapitalization program and acceleration of the restructuring of non-performing loans. Through these measures, banks are expected to be able to pull themselves out of crisis and resume their intermediary function in lending to the real sector. Other measures aimed at building greater resilience into the banking system included improvements to banking infrastructure, tightened rules on bank supervision, and introduction of good corporate governance.

These measures brought about a range of positive outcomes in bank performance during 2000, demonstrated by growth in assets, third party funds, fresh lending, loan quality, capital, and profitability. The bank recapitalization process reached completion through the issuance of the government recapitalization bonds that helped to reinforce bank capital and assets. The completion of this process and the extension of the government blanket guarantee also enabled the public to maintain confidence in the banking system. Banks have begun to expand their lending, even though this growth remains small, while progress in the restructuring of non-performing loans has enabled banks to improve the quality of the credit portfolio. Banks also achieved substantially improved profitability, reflected in the stronger net interest margin.

Although the banking industry has shown overall improvement, some banks still face difficulties over compliance with the CAR and non-performing loans. Deteriorating assets quality has driven the CAR of some banks to below the minimum required 4.0%. Furthermore, even though non-performing loans declined overall to 23.9%, at some banks the level of non-performing loans remained above the 35% limit. Consequently, challenges can be expected in achieving the next level of

bank-restructuring in which banks will be required to achieve a minimum CAR of 8.0% and bring non-performing loans down to a maximum of 5.0% by the end of 2001.

Banking Policy

As mentioned above, the focus of banking policy remained firmly on the continuation of efforts to accelerate the bank-restructuring process, which plays a key role in promoting economic recovery. To achieve this, Bank Indonesia carried out a program for strengthening of banking institutions and the resilience of the banking system. Bank Indonesia's policy decisions also took into account compliance with the various agreements reached with the IMF, World Bank, and Asian Development Bank.

Bank-Restructuring Program

As part of its program for bank-restructuring, Bank Indonesia extended the government blanket guarantee scheme and studied possibilities for the establishment of a deposit insurance agency, completion of bank recapitalization, expansion of lending, and restoration of the intermediary function.

Blanket Guarantee Scheme

To maintain public confidence in the banking system, the Government of Indonesia extended the blanket guarantee period until January 31, 2001, with a provision for automatic six-month extension in the absence of an announcement of termination of the scheme.¹⁾ The decree of the Minister of Finance for this expansion also stipulated the transfer of administration of the guarantee scheme from Bank Indonesia to the Ministry of Finance and the Indonesian Bank Restructuring Agency (IBRA).

The government's blanket guarantee scheme is an interim measure pending the establishment of the Deposit Insurance Agency. A study on possibilities for phasing out the blanket guarantee scheme was begun during the reporting year

with the aim of allowing banks opportunity to adjust themselves to the establishment of the new agency.

In accordance with the Memorandum of Understanding signed by the Governor of Bank Indonesia and the Minister of Finance on May 3, 2000, Bank Indonesia retains control of implementation of the guarantee scheme pertaining to trade finance and interbank debt exchange. Under this scheme, Bank Indonesia settled the repayment of \$495.9 million in loan principal and interest on interbank debt exchange offer. This amount represented part of the Rp53.8 trillion raised from the issuance of government bonds to Bank Indonesia under the government guarantee program in 1999.

Bank Indonesia also concluded a Memorandum of Understanding with the Ministry of Finance concerning the continuation of the blanket guarantee scheme for rural banks to provide certainty over which party is responsible for guaranteeing the deposits of rural banks, given that the guarantee of commercial bank deposits has been transferred to IBRA. In this regard, an amendment was introduced to Government Regulation Number 25 of 1999 concerning the Revocation of Operating Licenses, Dissolution, and Liquidation of Banks, in which rural banks are no longer required to shoulder liquidation expenses arising from settlement of all outstanding liabilities.

Bank Recapitalization Program

On October 31, 2000, the Government of Indonesia and Bank Indonesia completed the final phase of the bank recapitalization program. During 2000, six banks underwent recapitalization: Bank Bali, Bank Danamon, Bank Niaga, Bank Negara Indonesia, Bank Rakyat Indonesia, and Bank Tabungan Negara. The government issued recapitalization bonds valued at 148.6 trillion rupiahs, bringing the total value of bonds to 430.4 trillion rupiahs (Table 7.1.).

After several adjustments, including deduction for the proceeds from rights issues of the banks, the total outstanding value of government bonds at the end of 2000 came to Rp431.8 trillion. This adjustment included Rp6.9 trillion for buy-back of bonds resulting from excess sale of rights and IPO shares, con-

1) Minister of Finance Decree Number 179/KMK.017/2000 dated May 26, 2000, concerning the Government Blanket Guarantee Scheme for Liabilities of Private Banks.

Table 7.1
Government Bonds Issued for Recapitalization Program
(as of December 31, 2000)

Group of Banks	Number of Banks	Nominal Value (Trillions of Rp)			Total (Trillions of Rp)
		Fixed Rate	Variable Rate	Hedge Bond	
State-owned Banks	4	114.9	131.2	36.8	282.9
Taken Over Banks	14	33.9	75.4	-	109.3
Recapitalized Banks	7	18.0	18.9	-	36.9
Regional Development Banks	12	0.4	0.8	-	1.2
Total	37	167.2	226.4	36.8	430.4

version of hedge bonds to fixed rate bonds, and adjustment of hedge bonds value in accordance with the USD/rupiah exchange rate.

Following the completion of the recapitalization program, it is expected that bank capital will no longer constrain recovery in the banking sector. In addition, the recapitalization bonds are expected to provide a further source of funds for banks, whether by sale outright or collateralization. Despite this, the sale or collateralization of bonds faces further obstacles because of the low liquidity of the secondary market that force bond prices to drop below nominal value. Lack of interest in government bonds can be explained by the sharp fluctuations in domestic interest rates in contrast to the fixed rate of return for most of the bonds. To attract buyers, banks were compelled to offer high discounts, which in turn impacted capital. At the end of the reporting year, the value of bonds held by banks in the trading portfolio came to Rp 19.5 trillion. This was equal to only 4.5% of total recapitalization bonds, even though banks are permitted to trade up to 25.0% of the government bond portfolio.²⁾

At year-end, the portfolio of collateralized bonds totaled Rp12.1 trillion, or only 2.8% of the total bond portfolio. Further efforts are necessary to strengthen market liquidity for recapitalization bonds, which in turn will expedite the restoration of the bank intermediary function.

Program for Debt Restructuring and Restoration of the Intermediary Function

Banks have the option of conducting their own debt restructuring or using the mediation of the Debt Restructuring Task Force established by Bank Indonesia, while IBRA is in charge of restructuring bad debt taken over from state banks and recapitalized banks. Restructuring of foreign debts owed by non-bank companies is facilitated by the Jakarta Initiative.

In principle, the aim of debt restructuring is to provide opportunity for debtors to restart their business operations. In the case of debts retained within the bank credit portfolio, restructuring is aimed at fostering debtor compliance with their obligations to banks, which in turn will improve the quality of bank credit portfolios. IBRA-restructured debts will be returned to the banking system, also encouraging banks to resume lending. The key to success in debt restructuring lies in negotiations between creditors and debtors. Despite some strategic measures taken by key players in the process, progress has been slowed by technical difficulties, particularly over the size of the hair cut on debt principal owed to lending syndicates made up of foreign banks, state banks, and private domestic banks. Other factors hampering debt restructuring are the volatile exchange rate and the imposition of income tax payable by debtors on the hair cut.

The task force has taken several measures to move the debt restructuring process forward, including strengthened coordination with IBRA and the Jakarta Initiative. It has also devoted substantial effort internally to building professional capacity for mediation in the restructuring process. These efforts include the preparation of a due diligence manual for the mediation process, financial projections, and the use of necessary models.

IBRA's restructuring strategy³⁾ consists of the following:

a) Grouping of corporate debt by debt value, business pro-

2) Bank Indonesia Circular Letter Number 2/26/DPM dated December 8, 2000 concerning Guidelines for Series FR0006, FR0007, FR0008, FR0009 Government Bonds. This Circular Letter also stipulates the percentage of bonds that may be traded on the secondary market.

3) IBRA Strategic Plan 1999-2004 period

pects, repayment ability, and IBRA's ownership of other creditors; b) one obligor grouping; c) large-scale debt restructuring using financial and legal advisors, d) transfer of medium, small-scale and retail debt to several banks (outsourcing); e) litigation process for uncooperative debtors; and f) strengthening cooperation with competent agencies involved in the debt restructuring process. To accelerate the restructuring process for debt under Rp5.0 billion, IBRA has sold debt at discounts of 25.0%–50.0% on interest and 100.0% on penalty.⁴⁾

At the end of 2000, non-IBRA debt restructuring was under way for 20,430 debtors owing a total of Rp59.9 trillion in bad debts, or 71.4% of all non-performing loans. These loans were either restructured by the banks themselves or through mediation by the Task Force. At the same time, IBRA-restructured debt had reached Rp80.9 trillion, equal to 28.3% of the total Rp 286.3 trillion in bad debts transferred to the agency.

Building Resilience into the Banking System

During the reporting year, Bank Indonesia achieved progress in several key areas with the aim of building greater resilience into the banking system. Measures included: improvements in banking infrastructure through expansion of rural banks and sharia banking and commencement of a study on the establishment of a Deposit Insurance Agency to take over the government blanket guarantee scheme; amendments to banking regulations and bank supervision systems, taking into account the standards issued by the Bank for International Settlements (BIS) and Indonesia's commitments under its Letter of Intent to the IMF; and improvement in good corporate governance through the launching of the fit and proper test, stricter selection process of bank managers, and delivery of case files on investigation into banking crimes to law enforcement agencies.

Improvement in Banking Infrastructure

Efforts to improve banking infrastructure remained focused on the expansion of rural banks and sharia banks and the initial

preparations for establishment of a Deposit Insurance Agency. An important factor supporting this policy was the resilience demonstrated by rural banks and sharia banks in the face of volatile exchange rate and interest rate movements during the economic crisis. The expansion of these banks is expected to provide better protection for small depositors and safeguard public confidence in banking institutions.

Rural Banks

Bank Indonesia introduced new measures to strengthen supervision of rural banks and build capacity in human resources. In cooperation with German's Gesellschaft fur Technische Zusammenarbeit (GTZ), Bank Indonesia conducted studies on: establishment of a Deposit Insurance Agency for rural banks; empowerment of the association of rural banks to act as supervisor, consultant, and provider of training for members; and establishment of a buffer fund to extend assistance to rural banks with liquidity problems. Bank Indonesia and GTZ also conducted a baseline survey on public perceptions of rural banks, problems faced by rural banks, and training needs for their employees. To support this project, Bank Indonesia set up a working group with members from the Ministry of Finance, Ministry of Home Affairs, Ministry of Cooperatives, and GTZ consultants.

To strengthen the supervision of rural banks, Bank Indonesia adopted measures to improve enforcement of laws and regulations through training, seminars, and exposure visits for bank examiners and more intensive examination of rural banks with the assistance of public accountants. Bank Indonesia also received technical assistance from USAID and the Indonesian Bankers Institute for training and certification of rural banks, improvements in rural bank operating procedures and the integration of these procedures into the management of rural bank supervision, studies of successful rural banks, and the drafting of a recapitalization program for rural banks in West Java.

Sharia Banks

Bank Indonesia is strongly committed to the development of sharia banking in Indonesia. During the reporting year, efforts to promote sharia banking included a series of amendments

4) Only for debtor, whose debts below 5.0 billion rupiah, who are willing to settle his debt and who has ability to do so.

to banking regulations, the development of monetary instruments and a sharia money market, and human resources development for sharia banking.

Among the new sharia banking regulations were the Accounting Principles for Sharia Banking (PSAKS) and technical guidelines set out in the Accounting Guidelines for Sharia Banking in Indonesia (PAPSI). A team comprising members from Bank Indonesia, Bank Muamalat Indonesia, and the Indonesian Accountants Association (IAI) has completed their deliberations of PSAKS. In the process of setting up regulations on the CAR and earning assets quality, Bank Indonesia conducted a survey and simulation of the application of these concepts in October 2000. Results from this survey are expected to generate useful feedback for Bank Indonesia.

To develop monetary instruments appropriate to sharia banking, Bank Indonesia conducted a study on the participation of sharia banks in a Sharia Mutual Fund. Under this concept, units in this mutual fund could be collateralized to obtain short-term facilities from Bank Indonesia as a means of resolving liquidity problems.

In cooperation with the Indonesian Council of Ulemas (MUI), Bank Indonesia conducted a series of intensive promotions in several provinces, to familiarize potential customers with the benefits of sharia banking. Bank Indonesia also conducted a study of the potential, preferences, and behavior of banking consumers towards sharia banking in Java in a mapping exercise to obtain information on the growth potential of sharia banks.

In the area of human resources, Bank Indonesia provided basic training in sharia banking for participants from banks, universities, Islamic boarding schools, and interns from Bank Indonesia. The training was aimed at developing the understanding and skills of bankers, academics, heads of Islamic boarding schools, and Bank Indonesia's supervisory staff of sharia banks and to enable them to promote sharia banking to the public.

Deposit Insurance Agency

In 1999, the government established a working group that included Bank Indonesia to study the possibilities for establishment of a Deposit Insurance Agency as mandated by the Bank-

ing Act to replace the current blanket guarantee scheme. Included in this study is the examination of the requirements for establishment of such an agency, types of deposits to be covered, maximum limit of coverage, membership, premiums, form of entity, and ownership. As part of its contribution to the working group, Bank Indonesia conducted research in cooperation with a university on the various aspects pertaining to establishment of a Deposit Insurance Agency, including the current practice in other countries, paralleling its a study with a GTZ consultant on the establishment of a similar agency for rural banks. The Deposit Insurance Agency is expected to commence operation in 2004.

Improvement in Banking Regulations and Bank Supervision

Several new regulations were introduced during the year to strengthen the resilience of the banking system. These included regulations on the fit and proper test, status classification, exit policy, legal lending limit, debt restructuring, assessment of earning assets, short-term funds, trading portfolio for government bonds, sharia banks, bank monthly reports, intra-day liquidity facility, and form of entity of commercial banks. In accordance with the Letter of Intent to the IMF, bank supervision has undergone a change in paradigm to forward looking, based on risk-based supervision as defined by the 25 Basle Core Principles for Effective Banking Supervision.

Improvement in Banking Regulations

During the reporting year, Bank Indonesia issued a series of regulations addressing the areas of bank supervision, good corporate governance, prudential banking, bank liquidity, and the blanket guarantee scheme.

New regulations on bank supervision deal with the requirements and procedure for bank examination,⁵⁾ monthly reports for commercial banks,⁶⁾ and establishment of com-

5) PBI Number 2/6/PBI/2000 dated February 21, 2000, on Requirements and Procedure for Bank Examination.

6) PBI Number 2/21/PBI/2000 dated September 19, 2000 on Monthly Reports by Commercial Banks.

mercial banks.⁷⁾ The regulation on monthly reporting is a revision of earlier regulations on reporting by commercial banks to Bank Indonesia following the adoption of Statement of Accounting Principles Number 31 and brings reporting into line with progress in information technology. The regulation stipulates among others the reports to be delivered, reporting periods and procedure, delivery of corrections, and sanctions.

To improve the quality of bank management, Bank Indonesia introduced new regulations on the fit and proper test⁸⁾ and updated the procedures for determining test results.⁹⁾ These improvements address the issues of transparency of the evaluation process, length of imposition of sanctions, criteria of material losses, and evaluation after expiration of sanctions.

New prudential regulations address the provision of bank funds,¹⁰⁾ bank secrecy,¹¹⁾ acceleration of the debt restructuring process,¹²⁾ and exit policy.¹³⁾ The exit policy provisions provide for more transparent handling of problem banks by establishing criteria for banks designated for special surveillance and corrective actions by specified deadlines and the criteria for banks to be transferred to IBRA for restructuring. To expedite the debt restructuring process, Bank Indonesia updated its regulations on debt restructuring, legal lending limit, and earning assets. Under these regulations, the deadline for resolution of lending in excess of the legal lending limit was extended in the case of companies participating in debt restructuring under an official agency. Non-current risk weighted assets are assessed at book value after deduction for allowance

for earning asset losses. In other regulatory changes, a new limitation was placed on bank secrecy, which no longer applies for taxation, settlement of bank claims placed in the hands of the State Receivables Agency, and criminal justice cases, subject to prior authorization from Bank Indonesia. This authorization is waived in the case of a civil action between a bank and a customer, interbank exchange of information, written application of the customer, and application by legal heir of a deceased party.

New regulations on bank liquidity included the designation of government bonds for secondary market trading, the percentage of government bonds eligible for trading, and the administration of these bonds;¹⁴⁾ short-term funding facilities; and intra-day liquidity facilities. The short-term funding facility enables Bank Indonesia to extend assistance to bank with short-term liquidity problems through otherwise structurally sound, while the intraday facility is aimed at minimizing the possibility of gridlock in the payments system brought about by extremely short-term gaps in liquidity.

Concerning the government blanket guarantee scheme, the new regulations stipulate the rules for guarantee of interbank debt exchange offers and trade finance.¹⁵⁾

Tightened Banking Supervision

Under the agreement reached in the Letter of Intent signed by the Government of Indonesia and the IMF, Bank Indonesia drafted a master plan containing a core program to tighten on-site and off-site supervision. This core program, most of which was put into place during 2000, includes special surveillance and on-site supervisory presence (OSP) in a number of banks that play a significant role in the national economy. Most of the key elements of the master plan were put into action during the reporting year.

7) PBI Number 2/27/PBI/2000 dated December 15, 2000 on commercial bank

8) PBI Number 2/1/PBI/2000 dated January 14, 2000 on fit and proper test

9) PBI Number 2/23/PBI/2000 dated November 6, 2000 on fit and proper test

10) PBI Number 2/5/PBI/2000 dated February 21, 2000 on Provision of Funds Guaranteed by Other Bank

11) PBI Number 2/19/PBI/2000 dated September 7, 2000 on written consent and procedure to uncover the bank secrecy

12) PBI Number 2/15/PBI/2000 dated June 12, 2000 on debt restructuring, PBI Number 2/16/PBI/2000 dated June 12, 2000 on legal lending limit, Bank Indonesia Circular Letter Number 2/12/DPNP dated June 12, 2000 on risk weighted assets

13) PBI Number 2/11/PBI/2000 dated March 31, 2000 on the status of bank and its transfer to IBRA

14) Bank Indonesia Circular Letter Number 2/14/DPNP dated June 27, 2000 and 2/16/DPNP dated July 25, 2000 on the government's bonds to be traded in the secondary market. Bank Indonesia Circular Letter Number 2/18/DPM dated September 19, 2000 on the percentage of government bonds that can be tradable in the market

15) PBI Number 2/12/PBI/2000 dated May 16, 2000 on inter bank foreign debt guaranty and PBI Number 2/13/PBI/2000 dated May 16, 2000 on international trade financing guaranty

As required by the Letter of Intent, Bank Indonesia will soon standardize its bank supervision procedures in line with the international standards set forth in 25 Basle Core Principles for Effective Banking Supervision. To this end, Bank Indonesia has put together a Detailed Action Plan (DAP) setting out the key measures necessary to ensure compliance with international standard bank supervision by the end of 2002.

Key activities set out in the DAP include: (i) requirements for approval of licenses for establishment of banks and approval of bank owners and management; (ii) coordination among supervisory agencies in the financial sector; (iii) expansion of the scope of supervision to include banking policies, procedures, and internal control, in addition to the current scope of banking operations; (iv) risk-based supervision; (v) consolidated supervision of banks extending to affiliated companies; (vi) inclusion of market risk into the CAR.

While Bank Indonesia updated the DAP documents within the required deadline, it went further to build synergy between the activities set out in the master plan for supervision and similar activities in the DAP, in so doing producing the Bank Indonesia Master Document of Bank Supervision (MDBP). This document will serve as the principal guide for future bank supervision.

To ensure closer and more effective supervision of banks, bank supervision will no longer focus only on compliance, but will also include risk-based supervision. To this end, Bank Indonesia has deployed on-site supervisory officers four state banks and five private domestic banks, with training supported by IMF technical assistance. Two technical assistance experts from the IMF have been assigned to strengthen bank supervision with intensive Special Surveillance of banks with CAR below 4% and/or non-performing loans above 35.0%.

By implementing the Master Plan, OSP, and DAP, which also encompasses the 25 BIS Core Principles, Bank Indonesia has complied with its commitments in the Letter of Intent for the year 2000.

Good Corporate Governance

To strengthen and uphold good corporate governance in the banking system, Bank Indonesia requires existing bank owners

and managers to pass the fit and proper test, conducts interviews for nominee bank owners and managers, requires the appointment of a Compliance Director in each bank, and investigates banking crimes.

Fit and Proper Test

The fit and proper test is conducted on a regular basis to examine the track record of bank owners and management. Since 1999, Bank Indonesia has conducted the fit and proper test for 1,077 persons, comprising 93 owners and 984 management personnel. Of this total, 631 managers and 76 owners passed the test, while 243 other managers earned a qualified pass. Seventeen bank owners and 110 managers failed in the test and were disqualified from banking.

Interview of Nominee Owners and Management of Banks

To establish integrity and competence, Bank Indonesia holds interviews of nominee owners and managers of banks. By the end of the reporting period, Bank Indonesia had interviewed a total of 562 candidates proposed by 153 banks. From this total, 507 candidates successfully passed the fit and proper test.

Compliance Director

The appointment of the Compliance Director is a vital part of the internal control system of bank management. The function of the Compliance Director is to take active measures to prevent bank management from establishing policies and/or making decisions containing elements of non-compliance, irregularities, or violations of prudential regulations. As of December 2000, 161 banks had nominated a total of 216 persons for the position of Compliance Director. Bank Indonesia approved 156 of these nominees, while 30 were rejected, 14 subject to further evaluation, and 16 withdrew their nominations.

Investigation of Banking Crimes

Bank Indonesia's special unit for investigation of banking crimes (UKIP) worked hard to strengthen coordination with

the Attorney General's Office and the National Police in taking action against cases of banking crimes. During coordination meetings, officers from IBRA invited to participate as resource persons. As of December 2000, Bank Indonesia's investigation unit had handed over criminal cases involving 19 banks, including three rural banks, to law enforcement agencies.

Number of Banks and Offices

Commercial Banks

At the end of the reporting year, 151 commercial banks were in operation in Indonesia. This figure, which represents a decline of 13 banks from the previous year's total of 164 (Table 7.2), can be explained by the merger of nine taken over banks (BTO) with Bank Danamon, closure of three private domestic banks, and the merger of two joint venture banks (Table 7.3). As a result, total bank offices in Indonesia declined from 7,113 in 1999 to 6,509 in 2000.

Table 7.2
Number of Banks and Bank Offices

Group of Banks	Outstanding			Growth (%)		Share ¹⁾ (%)
	1998	1999	2000	1999	2000	2000
I. Commercial Banks						
Number of banks	208	164	151	-21.2	-7.9	100.0
Number of offices ²⁾	7,661	7,113	6,509	-7.2	-8.5	100.0
State-owned banks						
Number of banks	7	5	5	-28.6	0.0	3.3
Number of offices	1,875	1,853	1,736	-1.2	-6.3	26.7
Regional development banks						
Number of banks	27	27	26	0.0	-3.7	17.2
Number of offices	822	825	826	0.4	0.1	12.7
Private national forex banks						
Number of banks	71	47	38	-33.8	-19.1	25.2
Number of offices	4,157	3,798	3,302	-8.6	-13.1	50.7
Private national non-forex banks						
Number of banks	59	45	43	-23.7	-4.4	28.5
Number of offices	701	533	535	-24.0	0.4	8.2
Joint banks						
Number of banks	34	30	29	-11.8	-3.3	19.2
Number of offices	65	57	57	-12.3	0.0	0.9
Foreign banks						
Number of banks	10	10	10	0.0	0.0	6.6
Number of offices	41	47	53	14.6	12.8	0.8
II. Rural Credit Banks	7,607	7,772	7,764	2.17	-0.10	
Rural credit agencies	5,345	5,345	5,345	0.00	0.0	
Non Rural credit agencies	2,262	2,427	2,419	7.29	-0.33	

1) Share to all commercial banks
2) Excluding rural unit of BRI

Table 7.3
List of Merged and Frozen Banks in 2000

Banks Merged to Danamon June 30, 2000	Frozen Banks October 20, 2000
1. Bank Tiara Asia 2. Bank Nusa Nasional 3. Bank Tamara 4. Bank Rama 5. Bank Pos Nusantara 6. Bank Duta 7. Bank Risjad Salim Internasional 8. Bank Jaya Internasional	1. Bank Prasila Utama 2. Bank Ratu
	January 28, 2000
	1. Bank Putera Multifarsa
December 20, 1999¹⁾	
1. Bank PDFCI	
December 24, 1999¹⁾	
1. Hanvit ²⁾	
1) Merged on 1999, realization on 2000 2) Merger of 2 joint banks : – Korea Commercial Surya – Hanil Tamara Bank	

Rural Banks

Ten rural banks had their licenses revoked, while two new banks were established, resulting in a net reduction of eight rural banks to 7,764 during the reporting year. A further 96 rural banks were shut down and 79 rural banks issued approval in principle for sharia operations. Rural banks booked overall growth in assets, lending, and funds (Table 7.4), with operating losses reduced from Rp16.0 billion in 1999 to Rp11.0 billion in 2000. Despite improving performance, rural banks remain in a disadvantaged position compared to commercial banks that have made inroads in the same market segment.

Table 7.4
Indicators of Business Activities of Rural Credit Banks

Item	1997	1998	1999	2000 ¹⁾
	Billions of rupiah			
Business Volume	2,994	2,981	3,702	4,018
Deposits	1,601	1,527	2,054	2,332
Credit	2,288	1,986	2,593	2,875
Capital	623	706	778	812
Profit (Loss)	30	(42)	(16)	(11)

1) Projected figure

Sharia Banks

Significant expansion took place in sharia banking, with branch networks up from 37 offices in 1999 to 119 offices in 2000. At year-end, Bank Muamalat and Bank Sharia Mandiri had 27 branch offices, Bank IFI, Bank BNI, and Bank Jabar had collectively opened 10 dedicated sharia branch offices, while 79 rural sharia banks had started operation. Despite this, low market penetration was reflected in market share at only Rp1.71 trillion or 0.2% of total banking assets in Indonesia. Growth in sharia banking remains constrained by the limited number of bank offices, lack of trained human resources, and low public awareness of sharia banking.

Operations of Commercial Banks

Commercial banks recorded an overall improvement in performance during 2000. This performance was reflected in growth in total assets, funds, loans, earning assets quality, capital, and profitability (Table 7.5). This improvement was largely attributable to new policies adopted for restructuring of the banking sector, as well as improving macro economic conditions.

However, the bad experiences of the economic crisis and subsequent devastation of Indonesia’s corporate sector continued to act as a significant brake on new lending activity.

With limited options for placement of funds, most banks preferred to put short-term funds into SBIs and the interbank market for low-risk returns. As a result, banks were driven to maintain profitability by keeping deposit rates below the SBI rate, causing deposit rates to respond with low elasticity to increases in the SBI rate (Box: Sensitivity of Time Deposit Rates).

Bad experience during the crises has discouraged the banks to aggressively resume their lending activities. Most banks put their funds in Bank Indonesia Certificates (SBI) for risk-free return. This has driven the bank to offer deposit rate lower than the SBI rate.

Total Assets

Total assets increased by 2.4% over December 1999 to Rp1,030.5 trillion. The largest component of these assets was government bonds worth Rp431.8 trillion held by recapitalized banks, representing 41.9% of total assets. A further Rp59.8 trillion or 5.8% was held in SBIs, while the credit portfolio totaled Rp320.4 trillion or 31.1% of total assets (Chart 7.1). Accordingly, banks had substantial excess liquidity that could have been channeled into lending. Furthermore, the 31.1% percentage for lending was far below the pre-crisis position of over 70.0%. This shows that the bank intermediary function, which relies on bank lending, was

Table 7.5
Banking Indicators

Banking Indicators	1998	1999	2000
	Trillions of rupiah		
Total Assets	895.5	1,006.7	1,030.5
Deposits	625.4	617.6	699.1
Credits	545.5	277.3	320.4
Quality of Earning Assets :			
Current	408.2	607.2	591.2
Special mention	48.2	25.2	21.3
Sub-standard	57.5	28.1	32.3
Doubtful	83.7	35.4	16.9
Loss	135.5	28.5	29.3
NPLs - gross (%)	48.6	32.8	18.8
NPLs - net (%)	34.7	7.3	5.8
Capital	-129.8	-41.2	53.5
Profit (Loss)	-178.6	-91.7	10.5

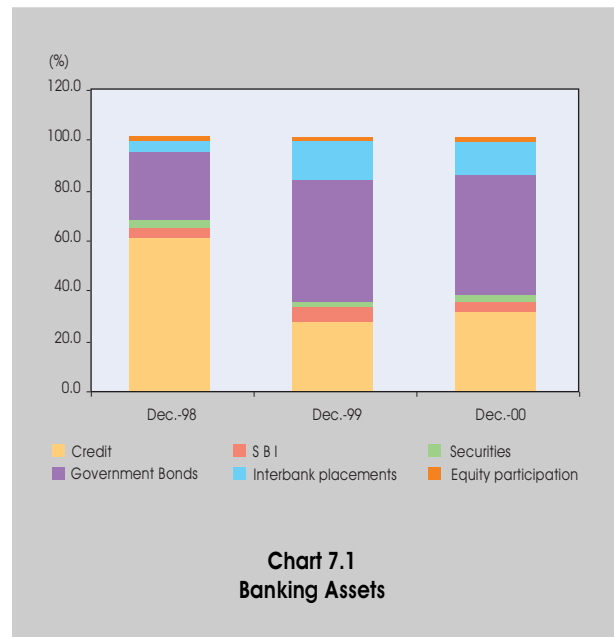

Chart 7.1
Banking Assets

still a long way from recovery. In addition, the massive proportion of government bonds in bank assets indicates that progress in sale of bonds on the secondary market and refinancing of IBRA-restructured debts by banks failed to meet expectations.

Funds

During 2000, banks recorded 13.2% growth in third party funds¹⁶⁾ to Rp699.1 trillion (Table 7.6), reflecting steady public confidence in the banking system. This growth took place across the full range of deposits in rupiahs and foreign currencies with the exception of rupiah time deposits, which declined 1.6%. Foreign currency deposits increased by 16.9% when converted to rupiahs, but with exchange rate depreciation excluded from calculation, these deposits actually diminished by 12.9%.

Time deposits accounted for the largest segment of funds at 55.0%, followed by savings deposits and demand deposits at 21.9% and 23.1% respectively. Both savings deposits and demand deposits recorded strong growth at 24.3% and 44.3%, while time deposits increased by only 0.5% after allowance for rupiah depreciation. After elimination of the impact of depreciation, time deposits actually declined year-on-year by 5.4%, indicating a shift in fund placements in favor of the more flexible options of savings deposits and demand deposits. Factors discouraging placements in time deposits included relatively low interest rates and ongoing political uncertainty.

Credit

During the reporting year, bank lending increased by 15.5% year-on-year to Rp320.4 trillion (Table 7.7), with rupiah loans up by Rp18.9 trillion (11.9%) and foreign currency loans by Rp24.2 trillion (20.5%). However, after elimination of the impact of exchange rate depreciation, foreign currency loans were down 10.8%, bringing overall lending growth during 2000 to only 2.2%.

Increased rupiah lending resulted from both new loans and the resale of IBRA-restructured debt to banks. During the

16) Non party fund based on the banking concept includes non-residences' and the government funds

Table 7.6
Composition of Deposits

Type of Deposits	Outstanding (Trillions of rupiah)			Growth (%)		Share (%)
	1998	1999 ¹⁾	2000	1999	2000	2000
Demand Deposits	99.8	111.8	161.5	12.1	44.4	23.10
Rupiah	57.4	68.5	103.6	19.3	51.3	14.82
Foreign currency	42.4	43.4	57.9	2.3	33.4	8.28
Time Deposits	456.9	382.8	384.7	(16.2)	0.5	55.03
Rupiah	300.4	301.4	296.7	0.3	(1.6)	42.44
Foreign currency	156.5	81.4	88.0	(48.0)	8.1	12.59
Saving Deposits	68.7	123.0	152.9	79.0	24.4	21.88
Rupiah	68.7	123.0	152.9	79.0	24.4	21.88
Foreign currency	–	–	–	–	–	–
Total	625.4	617.6	699.1	(1.2)	13.2	100.00
Rupiah	426.5	492.9	553	15.6	12.2	79.13
Foreign currency	198.9	124.8	145.9	(37.3)	16.9	20.87

1) Excluding interbank deposits

second half of 2000, banks extended a total of Rp26.5 trillion in new loans.¹⁷⁾ Debt restructured by banks themselves or with assistance from the Task Force at December 2000 came to Rp59.9 trillion owed by 20,430 debtors, representing 71% of total non-performing loans. In January 2001, IBRA reported the successful restructuring of Rp80.9 trillion out of the total Rp286.3 trillion in bad debt placed with the agency. During the reporting year, more debt was transferred to IBRA as part of the recapitalization of state banks.

The slow growth in lending can be explained by several factors. First, the number of potential debtors is limited, given the many large debtors still negotiating settlement under the IBRA debt restructuring program. Much of the new lending consists of small business loans. Second, even though new debtors are applying for credit, the banking sector considers the business sector to be fraught with risk. Third, debtors have not fully drawn on loan commitments because of the uncertain

17) Based on debtor information system resulted in the survey over a number of banks

Tabel 7.7
Composition of Bank Credits

Type of Credits	Outstanding (Trillions of rupiah)			Growth (%)		Share (%)
	1998	1999	2000	1999	2000	2000
By Economic Sectors	545.4	277.3	320.4	(49.2)	15.5	100.0
Agriculture	34.9	26.1	19.9	(25.2)	(23.8)	6.2
Mining	7.9	5.4	5.3	(31.6)	(1.9)	1.7
Industry	195.8	97.9	109.7	(50.0)	12.1	34.2
Electricity	23.6	20.0	5.1	(15.3)	(74.5)	1.6
Construction	41.5	13.3	7.2	(68.0)	(45.9)	2.2
Trade	96.1	45.2	46.0	(53.0)	1.8	14.4
Transportation	17.6	12.4	7.3	(29.5)	(41.1)	2.3
Business Services	88.6	26.4	26.4	(70.2)	--	8.2
Sosial Services	8.3	3.3	2.9	(60.2)	(12.1)	0.9
Others	31.0	27.3	90.6	(11.9)	231.9	28.3
By Category of Banks	545.4	277.3	320.4	(49.2)	15.5	100.0
State-owned banks	279.4	152.1	142.8	(45.6)	(6.1)	44.6
Private national forex banks	179.5	56.5	79.4	(68.5)	40.5	24.8
Private national non-forex banks	7.0	5.0	10.6	(28.6)	112.0	3.3
Regional development banks	12.8	13.6	11.5	6.4	(15.3)	3.6
Joint banks	37.5	22.5	29.3	(40.0)	30.0	9.1
Foreign banks	29.3	27.6	46.8	(5.9)	69.6	14.6
By Currency	545.4	277.3	320.4	(49.2)	15.5	100.0
Rupiah	315.3	159.1	178.0	(49.5)	11.9	55.6
Foreign exchange	230.2	118.2	142.4	(48.7)	20.5	44.4

business climate. Fourth, some of the recapitalized banks are beset by liquidity problems because of difficulty in selling recapitalization bonds on the secondary market. Fifth, several banks continue to face difficulties in compliance with the CAR and legal lending limit.

Earning Assets Quality

The year 2000 saw modest improvement in quality of earning assets, comprising credit, securities, government bonds, inter-bank placements, and equity participation. At year-end, problem assets accounted for 11.3% of total assets, down from 12.7% in the preceding year (Table 7.8) as a result of debt restructuring and additional funds raised from government bonds to finalize bank recapitalization.

Reflecting the progress achieved in debt restructuring, the ratio of gross non-performing loans to assets (without deduction for allowance for earning assets losses) fell from 32.8% in December 1999 to 18.8% in the reporting year (Chart 7.2). However, after inclusion of allowance for earning assets losses, the ratio of net non-performing loans at year-end was only 5.8%.

Table 7.8
Quality of Earning Assets

Classification	Outstanding (Trillions of rupiah)			Share (%)	
	1998	1999	2000	1999	2000
Current	408.2	607.2	591.2	83.8	85.5
Special Mention	48.2	25.2	21.3	3.5	3.1
Sub-standard	57.5	28.1	32.3	3.9	4.7
Doubtful	83.7	35.4	16.9	4.9	2.4
Loss	135.5	28.5	29.3	3.9	4.2
Total	733.1	724.5	691.1	100.0	100.0

Total value of non-performing loans eased to Rp83.9 trillion at the end of 2000, down year-on-year from Rp91.1 trillion. This improvement was attributable to new lending growth that increased the value of lending classified as current, in addition to the transfer of bad loans to IBRA. Measures intended to achieve the targeted 5% non-performing loan rate by the end of 2001 include accelerated debt restructuring, increased new lending, and transfer of restructured debt from IBRA to banks.

Promotion of Small and Medium Enterprises

Following the promulgation of Act Number 23 in 1999, Bank Indonesia's policy on lending for small and medium enterprises (SMEs) has undergone fundamental change. Businesses, includ-

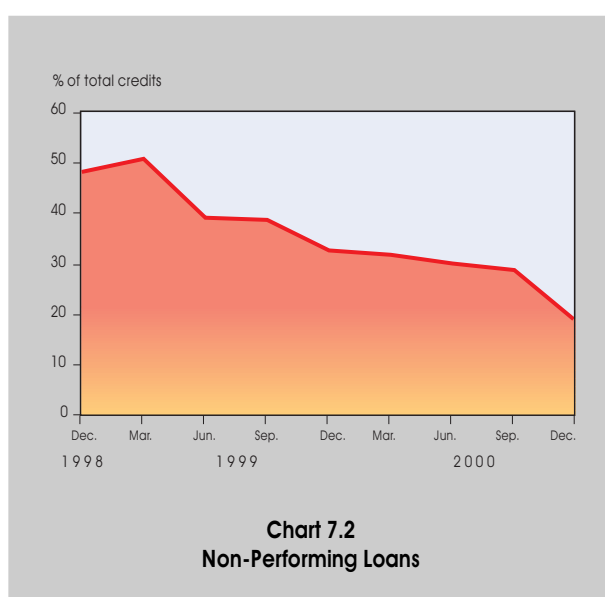
**Chart 7.2**
Non-Performing Loans

ing SMEs, are no longer eligible for Bank Indonesia Liquidity Credit. Instead, financing for SMEs is now the responsibility of the Government and the banking sector. Bank Indonesia adopted several policy measures for promotion of SMEs, detailed as follows:

- (i) increased provision of technical assistance to SMEs through research, training, and public awareness of facilities for SMEs;
- (ii) policies that encourage banks to expand their lending to SMEs, diversify credit portfolios through higher lending to SMEs and micro-enterprises, and extend credit with interest at market rates, and foster expansion of banking infrastructure through establishment of rural banks and sharia banks.
- (iii) facilitation of an SME information system using the Baseline Economic Survey Information System (SIB) and Export-Oriented Agro-Industrial Information System (SIABE) (Box: SIB and SIABE).

To ensure continued support for SMEs through program lending, Bank Indonesia has instituted new policies through the following mechanisms:

- (i) buyback of government notes to a maximum value of Rp10 trillion. Through this buyback, Rp1.5 trillion has been made available to offset the balance of Bank Indonesia Liquidity Credit for SMEs reaching maturity in 2000-2001.
- (ii) relending of funds repaid on Bank Indonesia Liquidity Credit through PT Permodalan Nasional Madani, BRI, and BTN, using existing program credit schemes operated by banks. As of December 2000, the three agencies had accumulated Rp1.5 trillion for funding SMEs.
- (iii) provision of Bank Indonesia Liquidity Credit for projects to which Bank Indonesia had committed funding before the transfer of Bank Indonesia Liquidity Credit to other agencies.

The introduction of these mechanisms demonstrates Bank Indonesia's continued commitment to development of SMEs. However, delivery of assistance to SMEs has been hampered, among others by slow action on the part of banks in putting available funds to use with approximately Rp3.0 trillion remaining in idle funds. To replace the former Farmer Credit scheme,

the Government has launched the Food Sustainability Credit program, with loan risks to be borne by banks while the Government provides an interest subsidy.

In a further effort to promote development of SMEs, Bank Indonesia conducted a series of studies on financing for the oil palm industry, transfer of technical assistance for SMEs to a non-Bank Indonesia agency, loan arrears from the Project for Bank Linkages with Community Organizations, and implementation of the regulation on small business loans.

Bank Indonesia's evaluation of primary cooperatives operating in the oil palm industry concluded that the primary cooperatives program still offered opportunities for further improvement and banks involved in the program had duly complied with their responsibilities as mandated in banking regulations.

The study on technical assistance recommended that technical assistance should remain the task of Bank Indonesia while activities carried out by agencies such as Regional Development Banks and PT PNM are merged, after which technical assistance could be carried out by a new agency.

Reasons discovered for loan failure in the Project for Bank Linkages with Community Organizations included an inadequate process for establishment of groups, misperceptions among group members, loose selection of members, low levels of participation, declining economic activity, and natural disasters. Statistical testing identified factors such as number of workers receiving training, number of groups served, motivation of banks in the project activities, and investigation of groups prior to lending. The variables of frozen savings¹⁸⁾ and monetary conditions had relatively little effect on the loan failures.

In addition to the studies described above, Bank Indonesia played an active role in promoting the importance of lending to SMEs and micro-enterprises. Bank Indonesia organized training activities for the development of small-scale and micro-enterprises and promoted lending models for a series of prime commodities offering growth potential for small-scale enterprises.

18) Frozen saving is a saving that is blocked to guarantee the loans

The study on bank responses to the regulation for lending to SMEs yielded the following results:

- (i) loans to SMEs are regarded as profitable because of the relatively low proportion of bad loans, diversification of risk, higher profit margin, lack of sensitivity to changes in interest rates, and compliance with loan repayment obligations;
- (ii) banks continue to regard the regulation on small business loans as a relevant measure despite the need for some changes, including: reduced penalties, adjustment in the required percentage of small business loans to the ability or characteristics of each bank, and increase in the small business loan ceiling to Rp500 million;
- (iii) internal factors affecting small business lending include simplification of small business loan procedures, branch office coverage, and delegation of lending authority, while external factors range from government policy toward SMEs, number of small-scale businesses, and Bank Indonesia's regulations on small business loans. Among the factors constraining growth in lending to SMEs are loan application requirements, in which applicants must have business license and taxpayer's number and furnish supplementary collateral.

Based on these findings, the regulations for small business loans were amended so that lending to SMEs would no longer be compulsory, but banks would nevertheless be encouraged to extend these loans.

Growth in small business loans during the reporting year reached a healthy 52.8% with loans totaling Rp56.9 trillion (Table 7.9), with the ratio of small business loans to total lending up year-on-year from 7.1% to 7.7%.

Capital

Following the completion of the recapitalization program, bank capital at year-end was in a considerably stronger position at a positive Rp53.5 trillion compared to the negative Rp41.2 trillion in 1999. In December 2000, the government held the majority of equity in the banking system (Chart 7.3. and Box: Government Ownership of Domestic Banks). In addition to recapitalization, banks also increased their capital as a result of higher earnings.

Table 7.9
Credit to Small-Scale Enterprises

Credit to small-scale enterprises	Outstanding (Trillions of rupiah)			Growth (%)		Share (%)
	1998	1999	2000	1999	2000	2000
By Usage	45.6	37.2	56.9	(18.4)	52.8	100.0
Working Capital	17.6	15.7	22.5	(10.8)	43.4	39.6
Investment	8.3	5.4	7.5	(34.9)	39.4	13.2
Consumption	19.7	16.1	26.8	(18.3)	66.6	47.2
By Economic Sectors	45.6	37.2	56.9	(18.4)	52.8	100.0
Agriculture	7.6	7.7	9.3	1.3	20.5	16.3
Industry	1.8	1.1	1.7	(38.9)	55.2	3.0
Trade, Restaurant and Hotel	10.7	8.8	10.3	(17.8)	17.3	18.2
Services	5.6	3.4	4.7	(39.3)	37.9	8.2
Others	19.9	16.2	30.9	(18.6)	90.5	54.3
By Type of Banks	45.6	37.2	56.9	(18.4)	52.8	100.0
State-owned banks	27.3	25.4	30.8	(7.0)	21.1	54.1
Private national forex banks	12.9	5.9	12.3	(54.3)	108.9	21.7
Private national non-forex banks	1.9	1.8	5.1	(5.3)	180.8	8.9
Regional development banks	3.4	4.1	8.7	20.6	111.0	15.2
Joint and foreign banks	0.1	0.07	0.1	(30.0)	0.4	0.1

Commencing from the second quarter of 2000, bank capital was positive for all categories of banks. State banks accounted for the largest share of capital at Rp21.3 trillion, with foreign banks at the other end of the scale with Rp0.7 trillion.

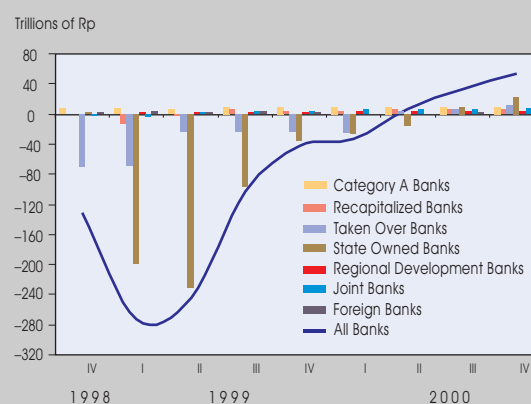

Chart 7.3
Banking Capital

Despite this, one of the large banks and several smaller regional banks still reported a CAR below 4.0%, mostly due to low levels of lending and the consequent inability to cover operating costs. Bank Indonesia continued efforts to encourage bank owners to inject more funds or merge with other banks. To monitor the CAR and factors affecting the CAR, Bank Indonesia conducted a stress test study (Box: Stress Test for Sensitivity of CAR to Interest Rate and Exchange Rate Movements).

Profitability

Banking activity showed some improvement during 2000, reflected in stronger operating profit. The banking sector booked a combined Rp10.5 trillion in net profit before tax, representing enormous progress compared to the Rp91.7 trillion loss before tax of 1999 (Chart 7.4). Profitability was driven mainly by non-operating profit (Rp11.2 trillion), including revenues from exchange rate differentials and correction to allowance for earning assets losses to take into account income from written-off loans, while operating profit remained negative at Rp0.7 trillion.

Despite negative operating profit, interest income reflected in the NIM climbed significantly from a negative Rp38.6 trillion to a positive Rp22.8 trillion (Chart 7.5). By the second quarter of the reporting year, all categories of banks had achieved a positive NIM, following the achievement of a positive spread

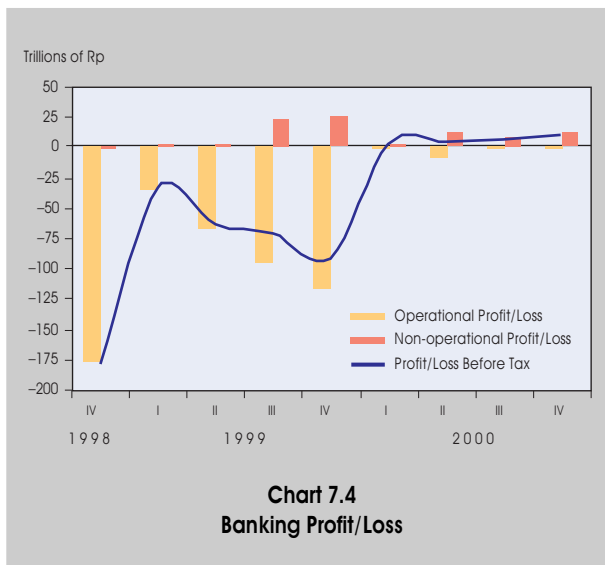

Chart 7.4
Banking Profit/Loss

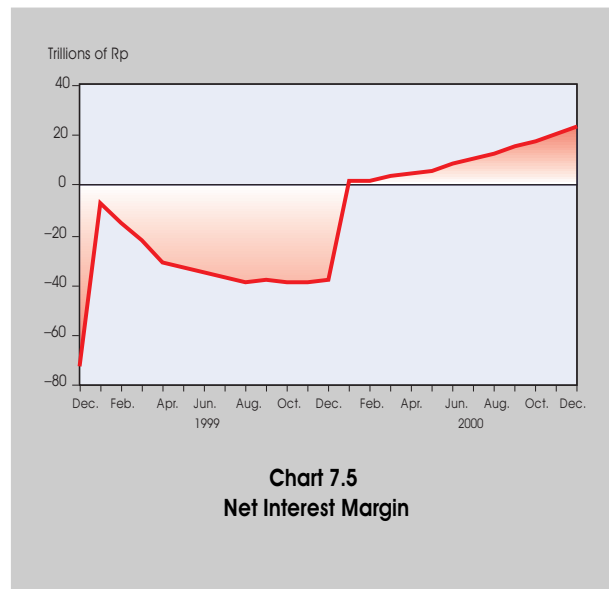

Chart 7.5
Net Interest Margin

in mid-1999 and additional income from interest earned on government bonds. Further improvement in the NIM is expected with recovery in the bank intermediary function.

Other Financial Institutions

Improving economic conditions during the reporting year had a positive impact on the performance of other financial institutions. With the banking system in stronger shape, more funds became available for multifinance companies to enable them to expand operations. Bank lending, however, remained considerably below pre-crisis levels, creating additional opportunity for the state-owned pawn company to meet the short-term borrowing needs of middle and low-income clients.

Multi Finance Companies

In general, multifinance companies closed the year on a better note compared to 1999. Total business turnover at October 2000 was up 17.5% from the previous year. The number of companies licensed for multifinance remained steady at 245. To promote expansion in the multifinance industry, the government issued new regulations for the establishment and licensing of new multifinance companies.¹⁹⁾

19) Minister of Finance Decree No.448/KMK.017/2000 dated October 27, 2000 on Multifinance Companies

Multifinance companies reported improved performance in all operations with the exception of factoring, which declined 16.8% during the reporting year. Leading in growth was consumer finance, up 64.5%. Business activity remains dominated by leasing, which accounts for 50.1% of all financing, followed by consumer finance (27.3%), factoring (20.5%), and credit cards (1.5%).

Multifinance companies accumulated a total of Rp3.9 trillion during 2000, representing year-on-year growth of 12.9% (Table 7.11). The main source of these funds was lending from local banks. Multifinance companies received 11.2 trillion in bank loans, up 4.2% from 1999, in response to increased demand for automotive purchases. In contrast, time deposits held by multifinance companies declined by a significant 16.0%, reflecting this increased pace of activity.

During the year 2000, use of funds for finance accounted for 76.4% of total funds or Rp26.1 trillion (Table 7.10), representing an increase of 17.5% over the previous year. Increased activity in finance was particularly noticeable in leasing for mining, forestry, and agriculture, and consumer finance, such as for automotive purchases arranged through a channeling system in cooperation with banks. The shifting in placement of

Table 7.11
Selected Indicators of Multifinance Companies

Item	Outstanding (Trillions of rupiah)			Growth (%)	
	1998	1999	2000 ¹⁾	1999	2000
Number of companies²⁾	245	245	245		
Business activities	29.5	22.2	26.1	-24.8	17.5
Leasing	15.6	10.9	13.1	-29.9	19.5
Factoring	8.0	6.4	5.3	-19.9	-16.8
Credit card	0.4	0.3	0.4	-15.9	14.2
Consumer financing	5.2	4.3	7.1	-16.9	64.5
Others	0.3	0.2	0.2	-33.3	-9.0
Borrowings	36.4	25.2	27.2	-30.7	7.9
Domestic	17.3	14.4	15.3	-16.9	6.2
– Bank	14.4	10.7	11.2	-25.5	4.2
– Non-bank	3.0	3.7	4.2	25.2	11.9
Foreign	19.1	10.8	11.9	-43.4	10.2

1) as of October
2) Units

funds to finance operations also provided an indicator that business had begun to regain some attractiveness in comparison to returns available on bank deposits.

Little improvement was recorded in the quality of earning assets, made up of leasing, factoring, credit card operations, consumer finance, securities, and equity participation. As of October 2000, problem assets classified as doubtful and loss had eased by 1.6% from the previous year to 32.2% (Chart 7.6). Ranking lowest in earning assets quality was factoring, with bad debts as high as 67.3%. At the other end of the scale was consumer finance, with problem assets at only 4.5% (Table 7.12).

State-owned Pawn Company

Perum Pegadaian, the state-owned pawn company, demonstrated significantly improved performance over previous years, having extended its service coverage at a time when the banking system was still struggling with recovery. During 2000, the pawn company expanded its branch network to 700 offices,

Table 7.10
Sources and Uses of Fund by Multifinance Companies

Item	Outstanding (Trillions of rupiah)			Growth (%)	
	1998	1999	2000 ¹⁾	1999	2000
Sources of Fund	43.6	30.2	34.1	0.0	12.9
Domestic bank borrowing	14.4	10.7	11.2	-25.2	4.2
Foreign bank borrowing	16.4	8.6	7.9	-47.7	-7.3
Other domestic borrowing	3.0	3.7	4.2	25.3	11.9
Other foreign borrowing	2.7	2.3	4.0	-17.6	76.7
Capital ²⁾	1.3	(1.3)	(0.8)	-202.7	37.5
Others	5.9	6.3	7.7	7.7	22.5
Uses of Fund	43.6	30.2	34.1	-30.7	12.9
Financing	29.5	22.2	26.1	-24.9	17.5
Bank deposit	6.0	5.1	4.3	-15.1	-16.0
Equity participation	0.3	0.1	0.9	-63.3	822.7
Others	7.8	2.8	2.9	-63.9	2.1

1) October

2) Net capital after compensated by unrealized profit/loss

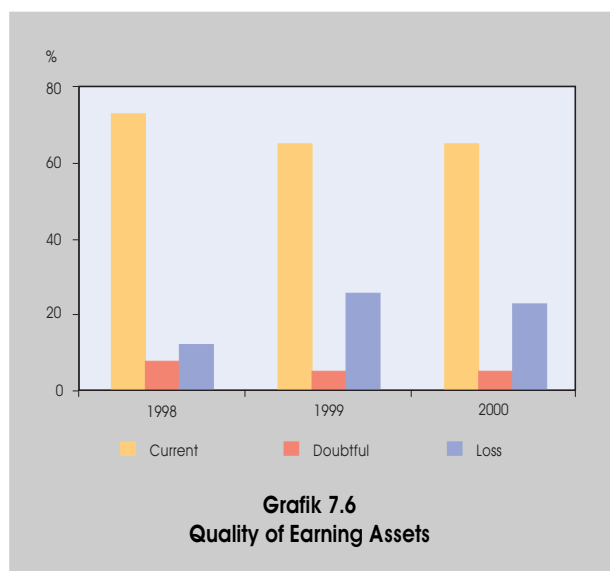

up from 650 in 1999. With bank-restructuring far from complete and banks consequently taking a cautious stance in lending, the state-owned pawn company offers a convenient alternative for middle and low-income borrowers to obtain loans on quick, easy terms. Most of these loans are short-term.

Increased activity was demonstrated by the key indicators of business turnover or lending, number of customers, and reduction in bad debts. As of December 2000, total transactions has climbed 31.0% to Rp4.2 trillion (Table 7.13). Despite

	1998			1999			2000		
	C	D	L	C	D	L	C	D	L
Financing									
Leasing	72.8	15.2	12.0	70.3	10.3	19.4	69.2	11.9	18.9
Factoring	67.1	5.6	27.2	36.3	5.2	58.5	28.5	4.2	67.3
Credit card	59.5	37.9	2.6	31.4	3.8	64.7	52.9	1.6	45.4
Consumer financing	92.6	2.9	4.6	90.9	2.4	6.7	93.7	1.9	4.5
Securities									
Equity participation	85.2	5.6	9.2	88.5	2.4	9.0	87.3	0.2	12.5
	61.4	0.0	38.6	97.8	0.0	2.2	97.5	0.0	2.5

C = Current
D = Doubtful
L = Loss

Table 7.13
Performance of State-owned Pawn Company

Item	1998	1999	2000 ¹⁾
	Millions of rupiah		
Credit extended	2,008,187	3,229,280	4,230,778
Operational income :	341,040	426,338	370,100
Capital leasing	319,520	401,030	341,933
Appraisal services	27	18	13
Consignment services	43	7	9
Income from custody and insurance	21,450	25,283	28,145
Liabilities			
Short-term liabilities	401,552	197,424	342,850
Bank loan	387,487	180,340	312,083
Others	14,065	17,084	30,767
Bonds	264,600	399,600	549,600
Long-term loan	100,000	100,000	100,000
Equity	371,273	407,666	450,397
Value of auctioned goods	21,869	91,712	38,943
Number of customers ²⁾	10,277,584	12,427,554	12,982,306

1) Data as December 2000, unaudited

2) Persons

this, operating revenue experienced a 13.2% decline to Rp370.1 billion. Capital leasing fell 14.7% year-on-year due to a reduction in the prevailing rates as bank interest rates declined. Despite this, capital leasing accounted for 92.4% of operating revenues.

The state-owned pawn company experienced 4.5% growth in its customer base during the reporting year. The largest group of customers is category A (credit ceiling ranging from Rp5,000 to Rp40,000), which comprises 37.1% of the company's 12.9 million customers. Most loans are to middle and lower income customers with livelihoods in manufacturing, fisheries, agriculture, and commerce.

Bad debt, reflected in the value of goods put up for auction, fell 57.6% to Rp38.9 billion (Table 7.13) following the redemption of most collateral goods by debtors. Funds for loans were raised mainly from bonds and equity, which accounted for 38.1% and 31.2% of funds. In March 2000, the state-owned pawn company converted Rp99 billion in bond debt to short-term debt while settling Rp90 billion owed to Bank Indonesia as required by the 1999 Bank Indonesia Act. In June 2000, the company raised a further Rp150 billion from a bond issue for working capital.

Box : Sensitivity of Time Deposit Rates

As a result of the unexpectedly prolonged process for restoring the intermediary function of the banking system, movements in SBI rates and the government guarantee rates have had relatively little effect on bank deposit rates. Increases in SBI rates and the guarantee rate have not been matched by commensurate increases in deposit rates; instead, deposit rates have responded in an asymmetrical pattern. During times of rising SBI and government guarantee rates, bank deposit rates remained relatively unchanged. In contrast, only while SBI rates were in decline did they become a reference for time deposit rates (Chart 1).

To learn the extent of influence of SBI and government guarantee rates on bank deposit rates, a sensitivity analysis was conducted by measuring elasticity in the one-month deposit rate against movement in the one-month SBI rate and the government guarantee rate for one-month deposits. The test uses weekly data from the fourth week of May 1999 until the fourth week of December 2000 divided into two periods according to the extent of influence of the SBI and government guarantee rate on the time deposit rate as depicted in graphical form.

During the first period, downward movement the SBI rate had a significant effect on time deposit rates. In contrast, the rising SBI rate during the second period had little impact on

the deposit rate. Thus the elasticity simulation tests conducted during the two monitoring periods produced differing levels of elasticity (Table 1).

The differing levels of elasticity were found to correspond to the upward or downward movement in the SBI rate. The declining SBI rate during the first period generated a very strong response in the time deposit rate, shown by the elasticity value of 0.88. For each 1.0% increment of decline in the SBI rate, there was a corresponding 0.88% decrease in the deposit rate. Conversely, the rising SBI rate during the second period produced a very small 0.09% response in the deposit rate. Each percentage point increase in the SBI rate was followed by a 0.09% increase in the time deposit rate. This low elasticity resulted in an increasing spread between the SBI rate and the time deposit rate while the SBI rate was on the rise.

Elasticity of the deposit rate against change in the deposit guarantee rate follows an almost identical pattern to the elasticity to SBI rate. During the first period, marked by decline in the guarantee rate, the time deposit rate showed an elasticity of 0.67. Thus for each percentage point drop in the guarantee rate, the time deposit rate came down by 0.67%. In contrast, when the guarantee rate rose during the second period, the deposit rate showed an elasticity of 0.48. This means that each percentage point increase in the guarantee rate was followed by a 0.48% increase in the deposit rate.

While the SBI rate was in decline, the banking sector clearly applied the rates as a benchmark for their funds rates. This was to be expected, given that as long as bank intermediary function is not fully restored, interest on SBIs will provide

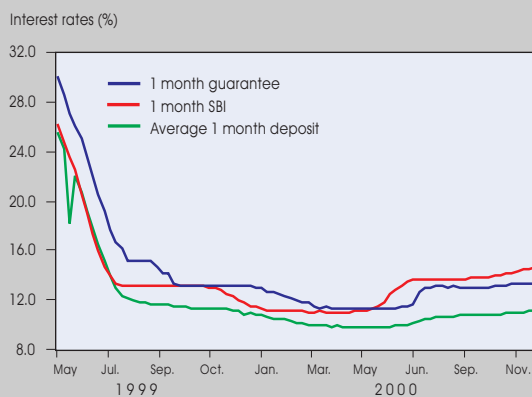

Chart 1.
Government Guarantee, SBI & Deposit Rates

Table 1. Time Deposit Interest Rate Elasticity		
	Test Period I May 1999 – June 2000	Test Period II June 2000 – October 2000
1 month SBI	down 1%	up 1%
1 month deposit	down 0.88%	up 0.09%
1 month guarantee	down 1%	up 1%
1 month deposit	down 0.67%	up 0.48%

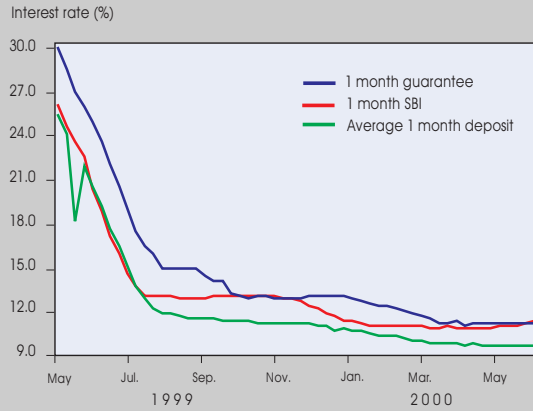

Chart 2. Interest Rates on Test Period I

one of the most important sources of bank revenue. Also, under these conditions, the banking sector also uses the guarantee rate as the upper limit in setting deposit rates.

Changes in the deposit rate-setting behavior of banks are evident from the differences between Chart 2 and 3. Before the second week of June 2000, the SBI rate stayed consistently below the guarantee rate (chart 2). However, when the SBI rate increased, the opposite effect occurred in which the SBI rate rose at a faster pace compared to the government guarantee rate (chart 3). This can be explained by the policy

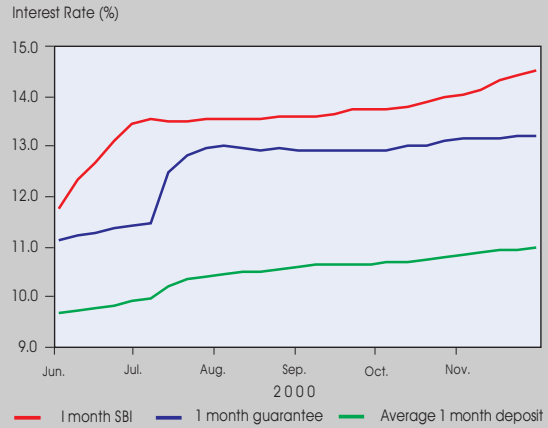

Chart 3. Interest Rates on Test Period II

of indexing of the guarantee rate to the deposit rates of JIBOR members + 200 bps. The SBI rate, however, is set in auction through bidding from the full range of banks in the industry.

On the other hand, the time deposit rate is determined by demand for liquidity and bank funds. The guarantee rate simply serves as an upper limit for the banking system when it becomes necessary. Thus when the SBI rate is on the rise, the time deposit rate (including the deposit rates for JIBOR member banks) remains steady. As a result, the SBI rates climbed at a faster pace than the government guarantee rate.

Box : Baseline Economic Survey Information System (SIB) and Export Oriented Agro-Industrial Information System (SIABE)

Following the promulgation of Act Number 23 of 1999, Bank Indonesia no longer has legal power to extend liquidity credit for the promotion of small and medium-scale enterprises (SMEs). Nevertheless, this sector remains an important concern for Bank Indonesia, given the vital role of SMEs in the economy and particularly in generating employment. Bank Indonesia's long track record in promotion of SMEs is another factor that has sustained its commitment to their continued growth and development.

In keeping with its policy for promotion of SMEs, Bank Indonesia has played an active role in providing information on the condition and potential for development of SMEs throughout Indonesia. In cooperation with several leading universities, Bank Indonesia conducted a Baseline Economic Survey with findings made available to the public through the Baseline Economic Survey Information System (SIB).

Using information gathered in the Baseline Survey, the SIB identifies SMEs with growth potential in all economic sectors in any particular region, and includes supporting information. The SIB serves as a highly useful tool for both the government and private sector in their efforts to promote SMEs, build integrated partnership programs, and promote investment within local regions. For added benefits to users, all information concerning the survey is easily accessible through the Bank Indonesia website (<http://www.bi.go.id> or <http://sib.bi.go.id>).

The information system offers (i) Priority List of commodities or business sectors at the sub-district level within a speci-

fied regency/province according to potential for growth, with information on the seven aspects of marketing, entrepreneurship, production technology, sectoral growth and linkages, infrastructure, and supportive government policies; (ii) Integrated Partnership Priority Commodity List, comprising a list of highly potential commodities by sub-district, along with supporting factors.

In addition to the SIB, Bank Indonesia has also developed the Export Oriented Agro-Industrial Information System (SIABE), designed to help users obtain information on agro-industrial products already sold to export markets. SIABE provides information on commodity origin, processing technology, list of exporters, export markets, and standard of product quality. The SIABE is expected to foster an improved investment climate in agriculture and agro-industry and enable faster, easier, and more accurate decision-making by banks and government agencies involved in setting investment policy.

During the preliminary phase, SIABE information is limited to 11 agricultural and agro industrial commodities: tea, coca, cashew nuts, palm oil, coffee, fish, shrimp, leather, sweet potato, wood carvings, and cassava. While plans are afoot for expansion of the system to cover all provinces in Indonesia, at the end of the reporting period SIABE information covered only the three provinces of West Java, Central Java, and South Sulawesi. SIABE is easily accessible through the Bank Indonesia website at <http://SIABE.bi.go.id>.

Box : Stress Test for Sensitivity of CAR to Interest Rate and Exchange Rate Movements

To monitor the sensitivity of the CAR to factors likely to trigger losses, Bank Indonesia introduced the stress test¹⁾ for a number of banks that play an important role in the Indonesian economy. Important factors regarded as likely to bring about losses include changes in interest rates and exchange rates. The stress test also comprises one of the recommendations of the BIS Committee on Banking Supervision concerning the implementation of risk management in the banking sector.

The test, which measures the effect of exchange rate fluctuation on the CAR, is conducted by measuring the net open position against each currency position and testing several scenarios of rupiah depreciation against these currencies. In practice, the stress test applies the worst-case scenario and the hypothetical scenario. The results of the stress test yield information on the sensitivity of the CAR to various scenarios of exchange rate depreciation useful both to Bank Indonesia and the bank itself. The information can also be useful in decision-making regarding monetary policy pertaining to the banking sector. If the scenarios produce a significant impact on the CAR, the bank is requested to cut back its net open position.

In contrast to the test for exchange rate depreciation, the stress test for rising interest rates uses information on exposures in funding and placement positions against movement in interest rates. When a bank has mismatch in maturity and interest rates in its funding and placement positions, movements in interest rates will expose the bank to potential losses. Each of the funding and placement positions is grouped into a number of time bands based on maturity (for fixed interest rates) and re-pricing date (for floating interest rates), produc-

Results of Stress Test for Sensitivity of CAR to Interest Rate & Exchange Rate Movements

Rupiah Exchange Rate decrease & Interest rate increase	CAR decrease 0 – 1%	CAR decrease 1 – 2%	CAR decrease 2 – 5%	CAR decrease > 5%	CAR increase
Rp 1,000 & 1%	4	3	0	1	19
Rp 2,000 & 2%	1	3	3	1	19
Rp 3,000 & 1%	0	3	3	1	20
Rp 4,000 & 4%	0	3	2	3	19
Rp 5,000 & 5%	0	1	4	3	19

*) Starting level of exchange rate is Rp9,530 (November 2000) and starting level of interest rate is 11.25% (average 1 month deposit rate as of November 2000)

ing a long²⁾ and a short³⁾ position for each time band. If a bank has a long position during a period of rising interest rates, it will book gains. Conversely, a short position will incur loss. This is similar to the effect of exchange rate movement, in which a bank with a long position will book gains and a bank with a short position will sustain losses.

The assumption used in the stress test is of rupiah depreciation taking place alongside rising interest rates with all other variables remaining constant. Results of the stress test, conducted on a sample of an industry-wide sample of 27 banks, are presented in the following table.

Test results indicate that rupiah depreciation taking place simultaneously with rising interest rates will have varying impact, depending on a range of factors including whether the bank has a long or short position. Depending on the impact, the CAR may rise or fall. The information made available from the stress test is thus highly useful in managing bank liquidity.

1) Stress test is the evaluation of the impacts of the volatility of interest rate and exchange rate against CAR by using certain scenarios.

2) Fund placement positions (left side of the balance sheet) is higher than fund source positions (right side of the balance sheet)

3) Fund source positions (right side of the balance sheet) is higher than fund placement positions (left side of the balance sheet)

Box : Government Ownership of Domestic Banks

In October 2000, the Government of Indonesia and Bank Indonesia completed the restructuring of the bank system through the issuance of government recapitalization bonds that had begun in May 1999. Six commercial banks completed their recapitalization during 2000: Bank Niaga, Bank Bali, Bank Danamon, Bank Negara Indonesia, Bank Rakyat Indonesia, and Bank Tabungan Negara. To finance the recapitalization, the Government of Indonesia issued bonds worth Rp148.6 trillion, bringing the total value of bonds issued under the bank recapitalization program to Rp430.4 trillion.

As a consequence of the recapitalization, at December 31, 2000 government equity accounted for 95.1% of ownership in domestic banks with the CAR after recapitalization at 12.7% (see graph). However, government equity in banks is an interim measure to be phased out through regular divestiture of bank shares. One positive impact of the recapitalization program is the basis laid for more diverse and equitable distribution of ownership in the future, which in turn will strengthen the independence of bank management. According to past experience, concentration of bank ownership within business groups placed serious limits on the independence of bank management.

Divestiture of government equity is planned to take place over not more than five years from the start of bank recapitalization, or by 2004. The government plans to divest its stakes in BCA and Bank Niaga during the first quarter of 2001. However, achievement of this target will depend largely on the pace of

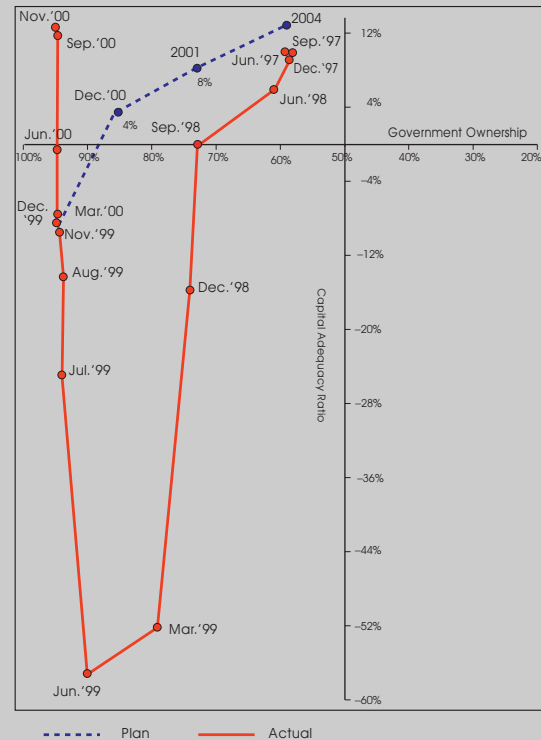

Evolution of CAR and Government Ownership in Banking

economic recovery and the extent to which this recovery strengthens bank performance and in turn improves the share price. During the reporting period, bidding by interested investors fell considerably short of the government target, preventing divestiture from proceeding as originally scheduled.

Chapter 8 *Payment System*



As stipulated in Act Number 23 of 1999, Bank Indonesia has the authority to govern and safeguard the payment system in order to facilitate and secure an effective, efficient, reliable and safe national payment system. In this regard, Bank Indonesia consistently undertakes measures in this area, concerning both cash and non-cash payment instruments.

Bank Indonesia's cash payment system policies in the year 2000 focused on revoking and withdrawing banknotes that had been counterfeited and issuing new banknotes. For the non-cash payments system, Bank Indonesia issued various measures to improve regulations in the clearing system, including regulations granting more authority to clearing system operators. One milestone in this area was the implementation of Real Time Gross Settlement (RTGS).

Payment System Policy

To maintain public confidence in the national payments system, Bank Indonesia issued various measures with respect to the cash and non-cash payment system. Policy measures for the cash payment system included issuing new banknotes to meet rising demand, and dealing with counterfeit currency found in several provinces (Box : The Process of Making Rupiah Banknotes and Coins, and Box : Counterfeit Notes, Problems and Solutions). For the non-cash payment system, Bank Indonesia continued its efforts in developing the RTGS system. In addition, Bank Indonesia improved the regulations on the clearing and settlement systems and audited its computer network to ensure the safety of the computer system for implementing the RTGS system.

In 2000, Bank Indonesia increased its stock of banknotes and coins due to growing demand for currency in line with increasing economic activities and public concerns over the Y2K issue. To standardize the sizes of rupiah banknotes and to improve security, Bank Indonesia issued a new rupiah 1,000 denomination with a new design and with sizes similar to the rupiah 100,000 denomination. To increase the circulation of

these new banknotes, Bank Indonesia deployed mobile banking units more actively to fulfill the needs of those celebrating religious events and New Year holidays.

To cope with growing problems of counterfeit currency in 2000, Bank Indonesia took preventative and repressive measures. Preventative measures were carried out by revoking and withdrawing the rupiah 50,000 banknote (Soeharto series dated 1993/1995), the rupiah 20,000 banknote (Cendrawasih series dated 1992) and the rupiah 10,000 banknote (Hamengkubuwono IX series dated 1992), as these series were frequently counterfeited. Additional preventative measures involved improving the design and adding security features to the new rupiah banknotes, and disseminating the features of authentic banknotes through printed media, billboards and workshop. Coordination was improved among institutions grouped under the National Coordinating Board for Counterfeiting and Forgeries Eradication (BOTASUPAL) which includes the police, the attorney general's office, the State-owned Currency Printing Company (PERURI), Customs and Immigration. Repressive measures were carried out through coordination with other governmental offices in arresting and bringing to the court those involved in counterfeiting activities.

With respect to the non-cash payment system, the clearing system in particular, Bank Indonesia also made certain improvements. Bank Indonesia delegated more authority to non-Bank Indonesia clearing operator to solve problems occurring in their respective local clearing areas, such as giving clearance for new clearing participants and resolving disputes among clearing participants. In order to reduce subsidy to banking sector, local clearing operators --whose average clearing items turnover within the past six consecutive months reached or exceed 1,000 units per day-- were also given authority to collect fees from local clearing participants.

The implementation of the RTGS system in November 2000 is an important step in the non-cash payment system. The

system processes inter-bank payment settlements on a real-time basis. The BI-RTGS system settles various types of transactions such as inter-bank transactions through the inter-bank money market, rupiah transactions for foreign exchange settlement, payment to government account, transactions for depositing or withdrawing cash from Bank Indonesia, and transactions between bank customers. Bank Indonesia is the fourth central bank in the ASEAN region to implement the RTGS system, following implementation by the central banks of Singapore, Thailand and Malaysia.

The BI-RTGS system benefits not only the banking industry but also the public and the economy as whole. For the public, in addition to providing speed and reliability, this system also provides certainty in sending and receiving funds, which facilitates the planning of economic activity. For Bank Indonesia, the system is useful in reducing payment system risk and speculative activity by participant banks. In addition, the RTGS system can also be a source of accurate information for bank oversight activities and for the implementation of monetary policy.

To implement the system smoothly, Bank Indonesia has taken extensive preparatory steps involving both internal and external partners. The central bank has prepared the system by improving its organization, staffing, equipment and infrastructure for the main site and its Disaster Recovery Center (DRC) and the supporting regulations. External preparatory steps include frequent meetings between Bank Indonesia and commercial banks for technical and non-technical purposes, training in the usage of the system, seminars on RTGS and its regulations as well as monitoring the readiness of bank's management and bank's internal committee of BI-RTGS participants. The central bank has also widely introduced the use of the BI-RTGS system. To secure the system, Bank Indonesia has hired international auditors to audit the security of the system and to conduct penetration tests.

Payment Instruments Development

The development of cash and non-cash payment instruments proceeded rapidly in line with increasing economic activities

in 2000. Use of cash and non-cash payment instruments also increased toward the end of the year with the approach of major religious holidays and the New Year.

Cash Payment Instruments

Currency in circulation increased in 2000, growing by 23.6% to Rp 89.7 trillion at the end of December from 72.6 trillion one year earlier (Table 8.1). The average end-of-month level of currency in circulation in 2000 reached Rp65.0 trillion, an increase of 21.1% relative to the average end-of-month position in 1999 of Rp53.6 trillion. The increase in currency in circulation was mainly due to the public's high demand for cash. The need for cash continued to rise in line with the development of various national economic indicators. The quantity of cash in circulation sharply rose, particularly in November and December 2000, increasing by 32.0%. This rise was due to large withdrawals by the public during Christmas and Idul Fitri, with these three events taking place at almost the same time.

There were not much change in the use of coins and banknotes in 2000. The market share of the two remained at 1.5% and 98.5% respectively. Besides providing a sufficient quantity of currency supply, Bank Indonesia also maintained the fitness of currency in circulation. This was done by destroying unfit

Table 8.1
Currency in Circulation by Denomination

Item	1998	1999	2000 ²⁾
	Billions of Rupiah		
Currency in Circulation¹⁾	48,329	72,560	89,705
Banknotes	47,435	71,480	88,370
100,000	—	5,526	6,832
50,000	18,941	36,909	45,630
20,000	13,643	16,560	20,472
10,000	9,566	7,389	9,135
5,000	3,311	2,757	3,408
1,000	1,232	1,620	2,003
<1,000	742	720	890
Coins	894	1,080	1,335
1,000	101	130	161
500	99	153	189
100	497	587	725
50	143	151	187
25	42	43	53
<25	12	16	20

1) Currency outside Bank Indonesia

2) Estimated as of December 30, 2000

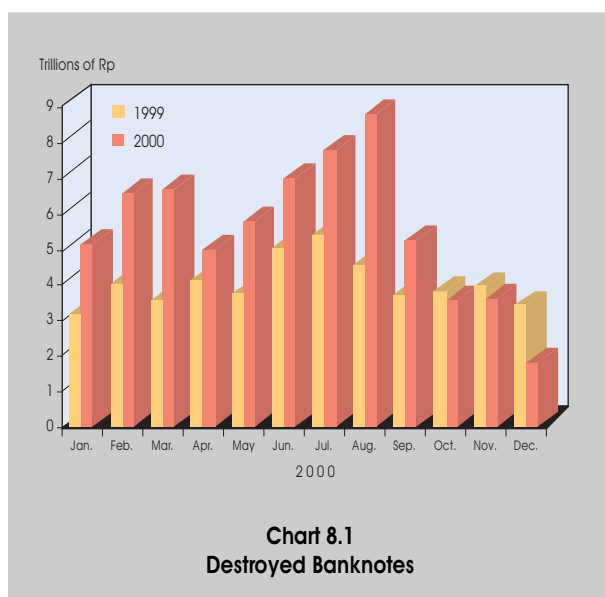

banknotes and replacing them with new banknotes. The amount of currency that was destroyed because it was no longer fit for circulation, or because the series had been withdrawn, rose by 38.5% in 2000 to 5.6 trillion from 4.0 trillion in 1999 (Chart 8.1). The rise was mostly due to the removal of the rupiah 50,000 denomination which was printed in 1993 and 1995 (Soehato series), the rupiah 20,000 denomination printed in 1992 (Cendrawasih series), and the rupiah 10,000 denomination printed in 1992 (Hamengkubuwono IX series).

Inflow, Outflow and Currency Held by Bank Indonesia

The inflow of currency from the public to Bank Indonesia in 2000 tended to fluctuate sharply. The monthly average inflow in 2000 rose by 22.6% to 12.3 trillion rupiah from around 10.0 trillion rupiah in 1999 (Chart 8.2). On the national side, the net outflow of the currency last year amounted to 17 trillion rupiah, in response to increased demand for currency from the public.

Almost all regional offices of Bank Indonesia on the island of Java experienced a net outflow in 2000. This was due to the fact that most of economic transaction occurred in Java. Currency held by Bank Indonesia at the end of 2000 fell 51.3% to 27.7 trillion rupiah from 56.9 trillion rupiah in 1999 (Chart 8.3). This fall was mostly due to the destruction of banknotes and large withdrawals by the public.

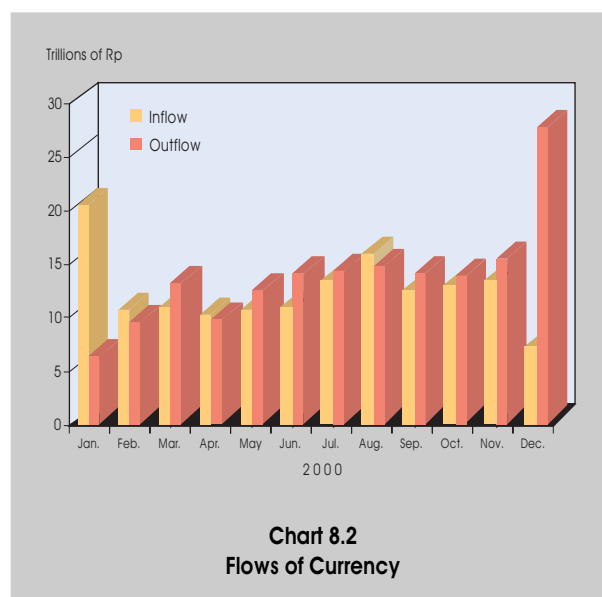

Discovery of Counterfeit Currency

Statistics on counterfeit currency from bank reports, the national police and Bank Indonesia indicate that between 1994 and November 2000, 989,621 counterfeit banknotes worth Rp 32.6 million were discovered (Table 8.2). These included 495,330 banknotes in the rupiah 50,000 denomination (50%) and 287,891 banknotes in the rupiah 20,000 denomination (29.1%). During the period January to November 2000, 317,124 counterfeit banknotes were discovered, an increase of 48.8% from 215,950

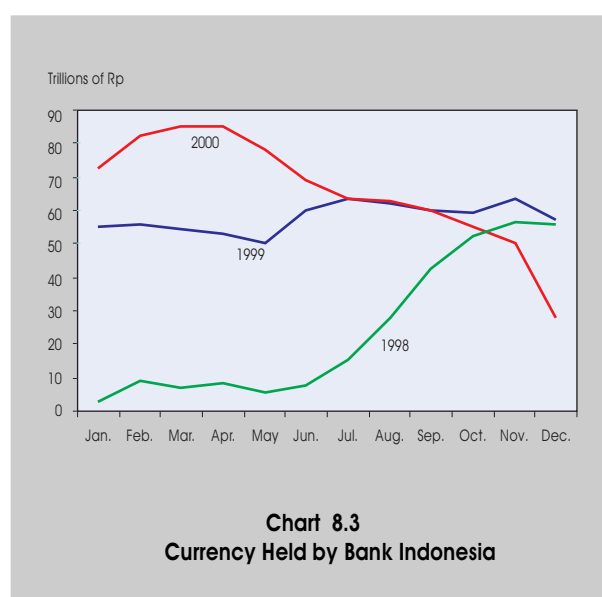

Table 8.2
Counterfeit Banknotes by Denomination
from 1994 to 2000

Period	Denomination				
	Banknotes				
	50,000	20,000	10,000	5,000	Total
1994	14	2,340	1,925	624	4,903
1995	74	5,349	7,224	403	13,050
1996	128	5,379	9,904	2,537	17,948
1997	16,392	139,938	82,274	234	238,838
1998	107,520	9,758	59,633	754	177,665
1999	89,137	100,536	26,053	224	215,950
2000 ¹⁾	282,065	24,591	12,766	1,845	321,267
Total	495,330	287,891	199,779	6,621	989,621

¹⁾ Up to November 2000

counterfeit banknotes discovered in 1999. Eighty-eight percent of these counterfeit banknotes discovered in 2000 were in the rupiah 50,000 denomination.

Most of the counterfeit notes discovered had not yet entered circulation. The national police discovered 83.7% of the counterfeit currency last year while the banks discovered the rest (Table 8.3).

The number of counterfeit banknotes discovered tended to rise. If compared to the number of genuine banknotes in circulation in each denomination, counterfeit banknotes amounted to between zero and 641 notes per one million legitimate notes (Table 8.4). To fight counterfeiting, Bank Indonesia cooperated with the National Coordinating Board for Counterfeiting and Forgeries Eradication, or Botasupal. Bank In-

Table 8.3
Counterfeit Banknotes by Sources of Report

Period	National Police	Banks
	Share (%)	
1998	84.4	15.6
1999	80.4	19.6
2000 ¹⁾	83.7	16.3

¹⁾ Up to November 2000

Table 8.4
Ratio of Counterfeit Banknotes to Currency in Circulation

Period	Denomination			
	Banknotes			
	50,000	20,000	10,000	5,000
1994	0.000000	0.000007	0.000003	0.000002
1995	0.000001	0.000014	0.000009	0.000001
1996	0.000001	0.000011	0.000014	0.000008
1997	0.000097	0.000250	0.000092	0.000000
1998	0.000284	0.000014	0.000062	0.000001
1999	0.000124	0.000123	0.000035	0.000000
2000 ¹⁾	0.000641	0.000041	0.000025	0.000004

¹⁾ Up to November 2000

donesia also improved the security features on banknotes. During the year 2000 Bank Indonesia conducted 55 workshops that were attended by students, teachers and important figures. Bank Indonesia conducted repressive measures against those engaged in creating counterfeit currency by bringing them to the court.

Non-Cash Payment Instruments

Transactions using the non-cash payment system, both paper transactions and electronic transactions, increased significantly in 2000 due to increased economic activities during the year.

Paper-based Payment Instruments

The nominal value of clearing activity increased by 41.7% in 2000, rising from Rp5.156 trillion in 1999 to Rp7.304 trillion in 2000. The volume of clearing items cleared in 2000 was less than in the previous year, with a lower volume at the end of fourth quarter due to a series of religious festivities at the end of year. During the fourth quarter, clearing activity declined relative to previous quarters. As a result, the volume of clearing item cleared in 2000 fell from 78,090 in 1999 to 73,707 in 2000, a drop of 7.9% (Table 8.5). This indicates that settlement through the RTGS system, which carries less settle-

Table 8.5
National Clearing Turnover and Dishonored Item

Clearing item	1997	1998	1999	2000			
				I	II	III	IV ²⁾
Presentment clearing							
Nominal (Trillions of Rp)	6,760	5,755	5,156	1,711	1,939	2,007	1,648
Volume (Thousands)	111,270	87,324	78,090	18,425	18,950	18,378	17,954
Dishonored items ¹⁾							
Nominal (Trillions of Rp)	20.3	24.9	12.3	3.1	2.9	3.8	4.2
Volume (Thousands)	1,944	1,247	852	203	225	227	237

1) Consists of dishonored Cheque, dishonored Bilyet Giro and other reasons
2) Up to December 2000 (Week 4 : Christmas, Idul Fitri and New Year holiday)

ment risk, has become increasingly attractive to the national banking system. Clearing activity has shifted from Jakarta Automated Clearing, or OKJ, and from Jakarta Electronic Clearing System, to the BI-RTGS system (Chart 8.4). Since the

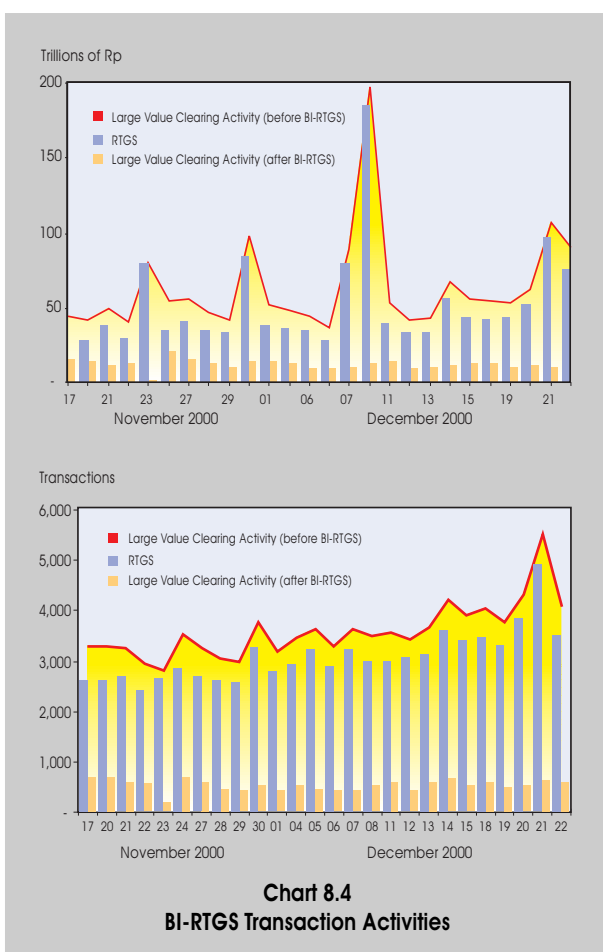

Table 8.6
Clearing Turnover and Dishonored Item

Clearing item	1997		1998		1999		2000 ³⁾	
	Jakarta	Outside Jakarta	Jakarta	Outside Jakarta	Jakarta	Outside Jakarta	Jakarta	Outside Jakarta
Presentment clearing								
Nominal (Trillions of Rp)	6,120	640	4,659	1,095	4,144	1,012	6,222	1,082
Volume (Thousands)	55,273	55,997	41,531	45,793	38,805	41,285	35,650	38,057
Dishonored items ¹⁾								
Nominal (Trillions of Rp)	43	5	21	2	8	5	9	5
Volume (Thousands)	1,548	396	803	245	458	394	496	395
Interbank Money Market ²⁾								
Nominal (Trillions of Rp)	6,244		6,641		2,250			
Volume (Thousands)	492		442		177			

1) Consist of dishonored Cheque, dishonored Bilyet Giro and other reasons
2) Since August 19, 1999, Interbank Money Market-Clearing is considered as large value nominal clearing
3) Up to December 2000 (Week 4 : Christmas, Idul Fitri and New Year holiday)

BI-RTGS system is still new, Bank Indonesia will keep monitoring this trend.

Jakarta remained the largest contributor for national clearing activity, accounting for around 85.2% of clearing activity (Table 8.6). The share of other regions fell to 14.8% from 19.6% previously. Based on the clearing local, the volume of clearing items in 2000 remained at 48% for Jakarta and 52% for other locals.

Dishonored clearing items (checks and bilyet giro) rose to 891,000 items by the end of December 2000 from 852,000 items at the beginning of the year. The nominal value of dishonored checks and bilyet giro rose to 14.0 trillion rupiah from 12.3 trillion in 1999.

The number of participants in the bank clearing system in 2000 fell to 1,973 banks from 2,178 banks in 1999 (Chart 8.5). The significant decline was in Jakarta, with a 12.5% drop to 596 bank offices from 681 in 1999. Outside Jakarta the number of participants fell to 1,377 from 1,497 bank offices in 1999.

Debit items accounted for the biggest share of clearing volume, at 54.6% (Chart 8.6), while credit items accounted for 45.4% of clearing volume. Bilyet giro were the most popular debit instrument with the share amount to 48.2% of total items (debit and credit), followed by checks with 6.1%. This meant that other debit instruments were rarely used.

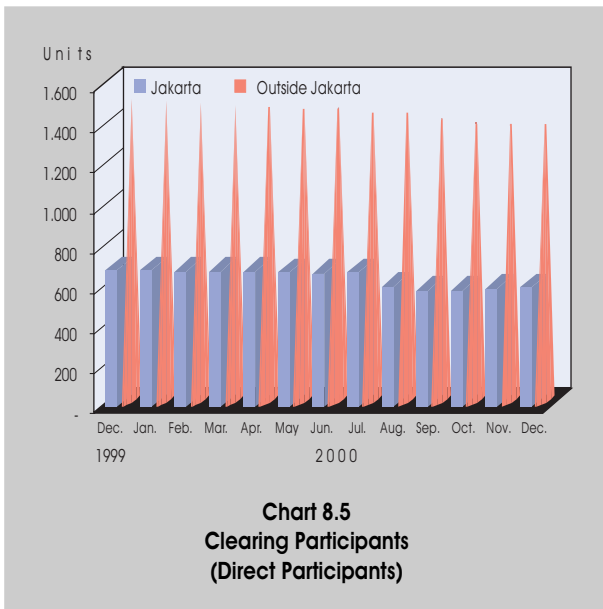

Electronic Card Non-Cash Payment Instruments

The development of electronic card payment instruments was in accordance with growing economic activity and also parallel with the development of currency in circulation and clearing activities. All types of electronic cards

Table 8.7
Nominal Growth of Non Cash-Electronic Payment Instrument

Item	Total ¹⁾	Growth Compared to (%)	
	2000	1999	1998
Credit Card	13,639	31.65	176.16
Debit Card	4,663	45.17	80.75
Smart Card	0,001	(99.65)	(99.97)
ATM	153,590	79.86	650.62
EFT/POS	0,898	7.99	95.28

1) In trillions of rupiah

rose toward the end of the period, except SMART cards (Tables 8.7 and 8.8). The value of the transactions (excluding SMART cards) rose 41.2% from the previous year. This showed the increasing acceptance of non-cash electronic card payment instruments.

The Plan to Develop a National Payment System

Improvement of Cash Services at the Head Office

To raise efficiency and to increase the quality of banking services, Bank Indonesia will relocate the currency distribution units, the Kota Cash Division and Thamrin Cash Division, to Building C of Bank Indonesia Thamrin. The relocation will take place simultaneously with the implementation of the back office system at the head office. The implementation of the Automatic Cash Administration system will enable Bank Indonesia to conduct all transactions on-line.

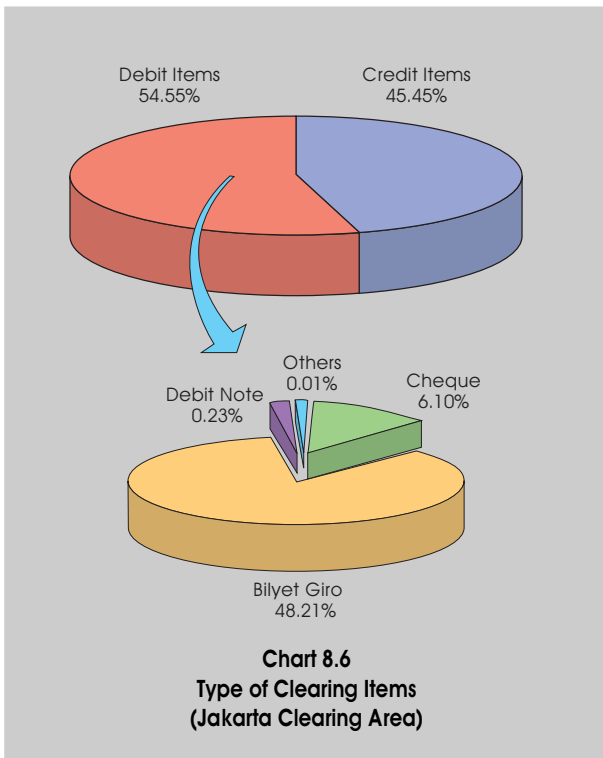

Improvement of Regulations on Deposits and Withdrawals

Increased commercial banking activity led to an increase in banknote management. To this end, Bank Indonesia has improved the regulations on the deposit and withdrawal of banknotes. The improvement will allow third party service companies to withdraw and deliver banknotes under the consent of the account holders in Bank Indonesia.

Table 8.8
Growth of Non Cash-Electronic Payment Instrument

	1998	1999	2000			
			I	II	III	IV
I. Credit Card						
Number of Holders (In persons)	2,028,442	2,043	2,070,147	2,171,667	2,368,370	2,622,604
Volume of Transactions (In thousands)	15,395	29,578	8,081	8,665	9,784	10,770
Value of Transactions (In trillions of Rp)	4.9	10.4	3.0	3.2	3.6	3.9
II. Debit Card						
Number of Holders (In persons)	5,374,376	12,110,970	12,327,766	12,448,780	12,824,485	13,103,676
Volume of Transactions (In thousands)	11,935	16,002	3,819	4,393	5,321	5,850
Value of Transactions (In trillions of Rp)	2.6	3.2	0.8	1.1	1.3	1.5
III. Smart Card						
Number of Holders (In persons)	83,190	29,918	25,750	25,396	25,279	25,075
Volume of Transactions (In thousands)	4,171	62	0.4	0.2	0.1	0.2
Value of Transactions (In trillions of Rp)	2.6	0.2	0.0	0.0	0.0	0.0
IV. ATM						
Number of Machines (In units)	5,985	6,012	6,119	6,227	6,433	6,767
Number of Holders (In persons)	13,169,663	16,195,251	13,989,452	17,278,118	17,859,821	18,786,094
Volume of Transactions (In thousands)	171,802	408,766	100,087	113,601	126,751	130,732
Value of Transactions (In trillions of Rp)	20.5	85.4	29.6	34.9	41.6	47.4
V. EFT/POS						
Number of Machines (In units)	4,213	5,089	5,523	5,793	6,599	7,005
Number of Holders (In persons)	46,652	53,322	51,564	54,527	57,701	61,934
Volume of Transactions (In thousands)	1,936	2,952	634	671	664	715
Value of Transactions (In trillions of Rp)	0.5	0.8	0.2	0.2	0.2	0.2

Currency in Circulation Information System Development

To support the currency circulation system, such as the structure of the printing plan, currency supply, paper for money, and currency distribution system, Bank Indonesia in 2000 introduced the Information System for Currency in Circulation (SIPU). The system has a specific database, which is separate from the Automatic Cash Administration System implemented in Bank Indonesia's cash office units. SIPU will provide most recent and updated information regarding cash office activities.

Banknotes Standardization

Bank Indonesia always considers comfort and ease of use when printing money. Bank Indonesia will only issue banknotes that can be used by the public and banks easily. Bank Indonesia has customized the width of its banknotes of all denominations and will continuously increase the security features of its banknotes. In

the future, users will be able to easily distinguish banknotes of different denomination from the length of each note.

RTGS Development

After the implementation of the RTGS system in its head office, Bank Indonesia will start bringing all Bank Indonesia regional offices network to RTGS environment. The target for 2001 is 12 regional offices. The integration of the BI-RTGS system in Bank Indonesia head office and its regional offices will bring about a centralized settlement account, in which all commercial bank accounts currently residing in each Bank Indonesia regional office will be merged into one account residing in one location, but can be accessed from any point in Indonesia.

The combining of accounts from those offices will benefit both Bank Indonesia and participant banks. It will ease the duty of Bank Indonesia in monitoring the bank compliance with the minimum reserve requirement. The combining of accounts can also be useful as an early warning sys-

tem to monitor which banks are experiencing liquidity problems. Participant banks can also monitor and manage their liquidity efficiently and effectively.

To reduce clearing risk, Bank Indonesia will enact a transaction cap regulation, which can hopefully be implemented in early 2001. The Cap regulation will require all transactions with a nominal value above one billion rupiah to be settled through the RTGS system. Any transaction below one billion rupiah will be executed through the clearing system.

In addition, to reduce settlement risk in money market and capital market transactions, Bank Indonesia will develop a first stage of Delivery Versus Payment (DVP) system. This development will result in an integrated settlement system of both the payment made through BI-RTGS and securities delivered through security settlement system.

Improvements of Support Clearing Activities

To reduce inter-bank settlement risk, and to increase efficiency and oversight in clearing activities, Bank Indonesia plans some improvements of regulations in 2001. The improvements will include:

Medan Automated Clearing Upgrade

Bank Indonesia will upgrade the reader/sorter machine in its Medan branch to an image-based system by the end of 2001. The upgrade is aimed at anticipating the increase of clearing volume in the city.

Bandung Automated Clearing Upgrade

The volume of clearing in Bandung has reached a level that cannot be properly served by semi-automated clearing system. This has led Bank Indonesia to upgrade the system to a fully image-based automated clearing system in anti-

ipation of a continued rise in the volume of clearing in the city.

The Development of Back Up Data Image Clearing in Jakarta, Bandung, and Surabaya

To overcome hardware and software deficiencies that cause the current system unable to store data for more than 30 days, Bank Indonesia will optimize the use of data imaging technology that can increase the quality of information, while remaining cost efficient. For this purpose, CD burners are to be provided to Bank Indonesia branches that use data imaging technology.

The Development of an Inter-Bank Bulk Payment System

Bulk payments are inter-bank routine payments which are high in volume and small in nominal value, such as credit card transactions, salaries, insurance and telephone bills. At present, many banks already have bulk payment systems that enable their customers to carry out such transactions through automatic debit account.

Development of a bulk payment system will reduce the operational cost of issuing vouchers, providing human resources and investment in machinery. The volume of clearing items due at bulk transaction payment has added to the burden on reader sorter machines, resulting in slower settlement. Bank Indonesia expects to be able to implement a special clearing system for bulk transactions in 2001 so that other inter-bank transactions through the clearing system will be more efficient.

Back End Switch Implementation

To raise the efficiency of book keeping and switching processes at banks that have automated teller machines, Bank Indonesia will use a moral suasion approach to facilitate and encourage banks to integrate their ATM networks.

Box : The Process of Making Rupiah Banknotes and Coins

According to Act 23 of 1999, Bank Indonesia is the only institution authorized to make and issue rupiah currency. In line with this specific function, BI must assure the availability of all denominations in good quality and in a condition fit for circulation, wherever and whenever needed. To achieve this goal, every issuance of new banknotes and coins must be considered an improvement in the cash payment system, especially in terms of acceptability and reliability.

Basic principles used in issuing new banknotes and coins are :

1. Simplification of the unit of account in order to speed up the cash payment system, with re-arrangement and simplification of denominations.
2. Adjustments to cope with economics variables such as inflation and the exchange rate.
3. Adjustments made to improve quality and efficiency in the process of issuing banknotes and coins, such as changes in security features in anticipation of the possibility of counterfeiting existing denominations.
4. Issuing commemorative banknotes and coins to celebrate or to memorize certain events.

Physical characteristics to be achieved in the issuance of new banknotes and coins include:

1. User friendliness. Regular users such as cashiers and community in general should experience greater convenience in using newly issued currency.
2. Durability, to extend the life of banknotes and coins in line with the type and denomination, focusing on :
 - a. Quality of raw material used, so that currency will stay in relatively good condition while being printed, will be resistant to the extremes of climate and humidity, will have better security features, and will not fade or be damaged easily.
 - b. Standard set can be achieved by the result of printing process.
3. Easily recognized, so that most users including users with disabilities can easily recognize each of the denominations by knowing the differences between their specific colors, designs, and measurements.

4. Secure against counterfeiting. To eliminate counterfeiting, a good combination of design, security features, and a sophisticated printing process must be achieved in every issuance of banknotes and coins.

Economic variables are used as parameters in every new issuance banknotes and coins, especially to ensure that a sufficient quantity of currency is available. These variables are the growth of currency in circulation, the inflation rate, the interest rate and the exchange rate. In addition to economics variables, the removal of currency unfit for circulation and the outstanding currency position are important factors in calculating the amount of new currency to be issued.

Issuance of new currency should be based on comprehensive research and good planning, so it will result in good quality banknotes and coins with a fair level of printing expense. To achieve this result, the decision to issue new banknotes and coins is always taken long before the issuance date, and comprises the following steps :

1. Preparation Stages
 - a. Determining the design
 - To choose a primary and supporting design with a nationalistic theme, including common characteristics such as vegetation, animal, arts, natural scenery, culture and national heroes. The design of watermarks is also chosen in this step.
 - To make each denomination easily recognizable from its color alone. In this step BI decides the color of each denomination. In addition, the dominant color is gradated in some parts of the banknote as a security precaution.
 - The dimension of banknotes must consider user convenience, and acceptability in all ATM machines, vending machines and sorting machines.
 - Text printed on banknotes must be designed in readable and un-readable condition.
 - b. Choosing Security Features

Security features are important for the prevention of counterfeiting and must consider :

- Better security features for bigger denominations.
 - Based on research, bigger denominations needs more (quality and quantity) sophisticated security features installed.
 - Security features used must be better than the development of general printing technology, such as electronic scanners, color management software and sophisticated hardware.
- c. Placement of security features
- Before installing security features, printing companies and sorting machine vendors must be contacted to decide where the security features will be placed:
- Regular users should be able to easily recognize overt security features.
 - Sensors in sorting machines should be able to detect covert security features. If new security features are installed, sorting machines must be adjusted; the cost of adjustment should be minimized.
- d. Pre-printing Stage
- If the design and security features used are already set, BI asks the currency printing company to send a formal letter of proposal concerning the true design. If the proposal meets the requirements, it will be passed to the Board of Governors (BOG).
 - Based on BOG's decision, the printing company makes master dies and plates. In line with this process, the raw materials that meet the specification are ordered.
- The printing company presents a sample of banknotes printed on some big sheets and some single banknotes. If both meet the requirements, they will be presented to the Board of Governors for approval. Based on the Board of Governors approval, the printing company will start to print banknotes in the quantity ordered by Bank Indonesia.
2. Production Stages
- a. In accordance with Presidential Decree Number 34 of 2000, the printing of currency must be done by Perum PERURI, unless PERURI has stated its inability to produce a specific denomination. If this happens, the production process could be done elsewhere.
- b. The result must be good quality banknotes and coins, and must meet all the criteria.
- In this stage, all newly printed banknotes and coins received from PERURI must meet the schedule of delivery of Perfectly Printed Banknotes or Coins, which has been agreed by BI and PERURI. However, if there are any Imperfectly Printed Banknotes and Coins in the package from PERURI, BI will destroy or incinerate them.
3. Campaign for the Issuance of New Banknotes and Coins
- A campaign for the new banknotes and coins should be held sometime before the issuance date, so that the community will notice and understand the characteristics of the new banknotes and coins. The campaign is done through press releases, brochures, leaflets, the mass media, and other channels.

Process in Making New Currency (Banknotes and Coins)

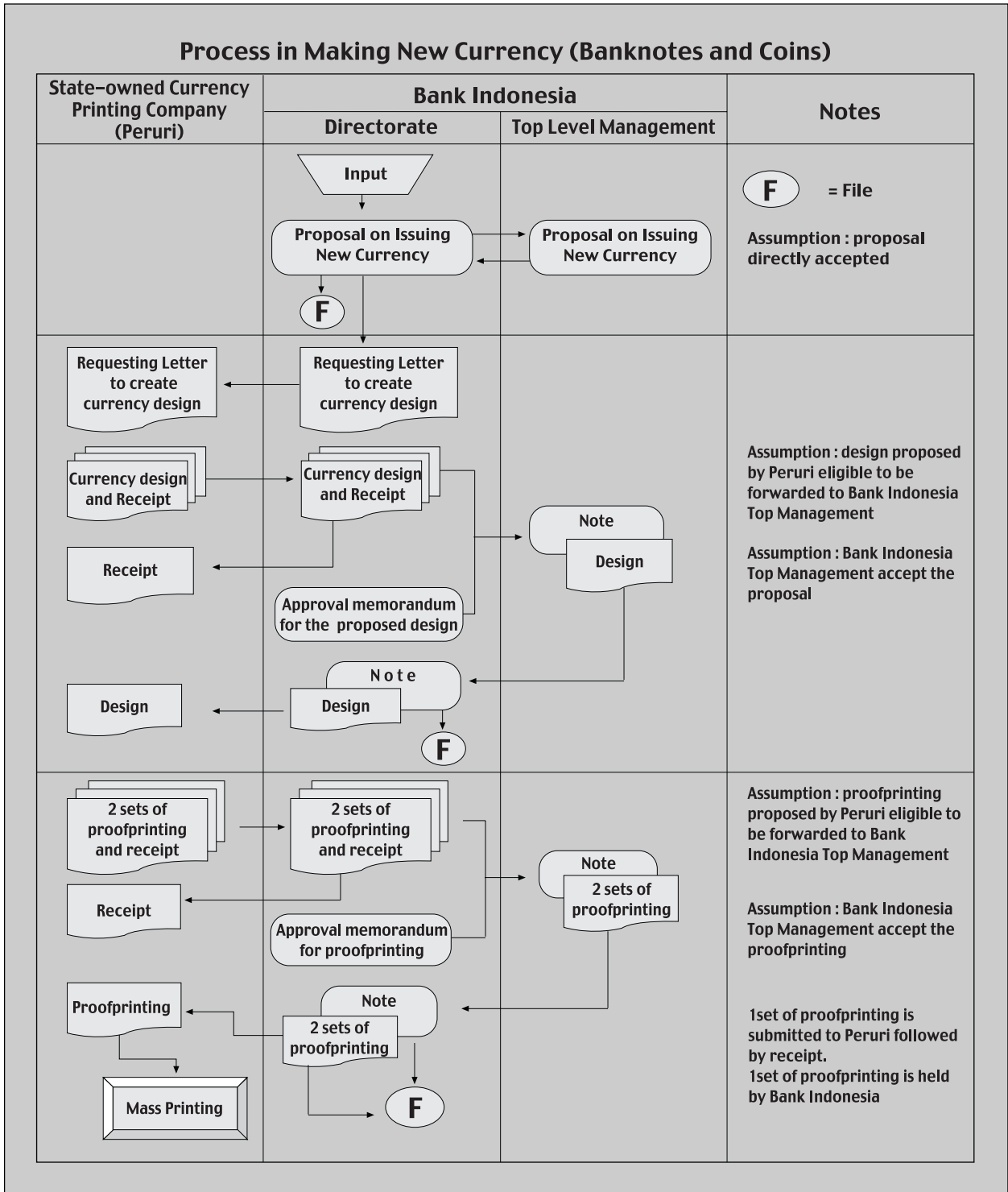

Box : Counterfeit Notes, Problems and Solutions

Currency counterfeiting is a problem faced by most countries in the world, including Indonesia. The possibility that counterfeit currency will find its way into the payment system is unavoidable. This is because currency has strategic functions for human existence and for the continuation of a nation and/or government. The strategic role of currency is due to the fact that it can be used not only as a medium of exchange to fulfill economic needs, but also as a political tool to undermine a nation's economy. To ensure that a nation's currency will serve its proper role and function, preventive and repressive actions must be carried out to prevent counterfeiting activity.

Over the past few years, particularly since the start of the monetary crisis in mid-1997 which developed into a full scale economic crisis, the creation of counterfeit currency has become an issue receiving a great deal of attention in the mass media. Factors contributing to counterfeiting activity include:

- a. The fact that most people are not fully familiar with the characteristic of genuine rupiah banknotes and coins, and therefore they cannot distinguish between counterfeit and genuine money.
- b. The high volume of currency inflow from the public, which limits the ability of banks to sort and detect counterfeit currency.
- c. The public's lack of awareness of counterfeiting activity due to insufficient information and resistance to reporting findings of counterfeiting, which promotes the spread of counterfeit money.

To anticipate such crimes, Bank Indonesia as the institution authorized to issue rupiah banknotes and coins undertakes certain preventative actions, which include :

- a. Socializing the characteristics of genuine banknotes and coins through electronic media, training for cashiers and teachers, brochures, leaflets, etc.
- b. Installing more sophisticated security features (such as improved raw material, design, color and printing techniques) in new banknotes and coins issued.

- c. Promoting better coordination with BOTASUPAL.
- d. Promoting international cooperation in actions against counterfeiting.
- e. Making people well informed about parties that must be contacted if counterfeit currency is detected.

Repressive actions are also undertaken to eliminate counterfeiting. These actions mainly involve informing the proper authorities so that sanctions can be applied (e.g., the attorney general and police).

According to banks and to police reports, there was an upward trend in detection of counterfeit currency between 1998 and 2000. Compared to 1998, detection of counterfeit currency in 1999 increased by about 21,6%, and by another 48,8% in 2000. Altogether 321,267 counterfeit banknotes were discovered between January and November 2000, amounting to 0.0004% of currency in circulation, with 16.3% of these counterfeit notes detected by banks, meaning they were already in circulation, and the remainder (83.7%) discovered by the police, meaning they were not yet in circulation.

Counterfeiting techniques can be grouped into printing techniques and raw material techniques. The most common printing technique is offset printing (64,2%), while the remainder from color printers. Raw materials commonly used as material for counterfeiting are cotton fiber security paper, which is the raw material for printing security certificates. The difference between this type of paper and genuine banknote paper is that it does not illuminate under an ultra violet lamp.

Currency counterfeiting is a criminal activity and the institution authorized to undertake repressive measures is therefore the national police. Bank Indonesia concentrates on preventative measures to assist the responsible authorities, in accordance with the duties and responsibilities of the central bank. However, banks and the public must also take responsibility for overcoming counterfeiting activity.

Bab 9 *The World Economy and International Cooperation*



The World Economy and International Cooperation

World Economy

The development of the world economy during the year 2000 was marked by more rapid economic expansion in various regions, a continuation of trends in the previous year. This continued expansion was accompanied by increased world trade volume, increased inflationary pressure in various advanced countries, a strengthening of the U.S. dollar against major world currencies (although it weakened again late last year), and a tendency for world stock markets to decline (Table 9.1).

The expansion of the world economy was supported by the expansion of the U.S. economy, the strengthening of the economies of Europe and South America, and the continuation of economic recovery in several Asian countries. Expansion of the U.S. economy continued to be based on strong

domestic demand. As the locomotive of the world economy, the continued expansion of U.S. economy had a positive impact on export performance in various regions, particularly in Europe, Asia and South America.

The continued expansion of the world economy was accompanied by increased inflationary pressure, particularly in industrial countries. Strong inflationary pressure came not only from the demand side but also from the supply side. From the supply side, inflationary pressure was mainly attributable to rising production costs due to a rise in world oil prices and a weakening of several major currencies. The rise in oil prices had broad implications for the cost of living and therefore stimulated demands for salary increases in various countries. This added to inflationary pressure and made it more difficult to achieve inflation targets, particularly in oil importing countries. To cap inflationary pressure, several advanced countries continued to implement tight bias monetary policies through the first half of 2000. However, with indications that economic activity was slowing and that oil price might be declining, the monetary policy stance in several countries shifted to a more neutral position in the fourth quarter of 2000.

Rapid economic expansion and the continued rise of U.S. interest rates resulted in the strengthening of the U.S. dollar globally, particularly against the euro and the yen. To limit upward pressure on the dollar, particularly relative to the euro, a number of central banks in G-7 countries undertook joint intervention in the third quarter of 2000. This intervention was not very effective. Intervention continued during the fourth quarter of 2000, in line with indications that economic growth in the U.S. was slowing.

In the first half of 2000, the development of world capital markets was marked by rising prices for information technology stocks. However, share prices fell in the second half of the year as a result of market response to the possibility of declining demand for information technology products in line with indications that global economic growth was slowing.

Table 9.1
Selected World Economic Indicators

Item	1998	1999	2000 ¹⁾
Economic Growth (%)			
World	2.6	3.4	4.7
Industrial countries	2.4	3.2	4.2
Developing countries	3.5	3.8	5.6
Countries in transition	-0.8	2.4	4.9
CPI (%)			
Industrial countries	1.5	1.4	2.3
Developing countries	10.1	6.6	6.2
World Trade Volume (percent change)	4.3	5.1	10.0
World Trade Prices (percent change)			
Manufactured goods	-1.2	-1.2	-5.3
Non-oil and gas primary commodities	-14.7	-7.1	3.2
Oil	-32.1	37.5	47.5
Major currency			
Yen/\$	130.9	113.7	107.8
\$/Euro	-	1.0660	0.9238
Interest rates in industrial Countries (Average in percent)			
Short-term	4.0	3.5	4.5
Long-term	4.5	4.7	5.0

1) Projection figure
Sources : IMF, World Economic Outlook, October 2000.
Bloomberg, and other external publications

Although in general the world economy improved, a number of risk factors and uncertainties shadowed the sustainability of economic expansion in various regions. Among advanced countries, the gap between the economic performance of the U.S., on the one hand, and Western Europe and Japan on the other, remained wide (Chart 9.1). The U.S. economy experienced a rapid acceleration of growth but economic expansion in Western Europe was relatively slow and the Japanese economy remained vulnerable, although Japan did begin to recover. Among emerging markets, particularly in the Asian region, progress in private sector restructuring had yet to run smoothly and therefore this region was still prone to external shocks.

The United States

U.S. economic growth reached 5% in 2000, up from 4.2% in 1999. Economic growth in 2000 was generally still supported by strong domestic demand, particularly from consumption and private investment. To limit the growth of domestic demand and to achieve a soft landing for the economy, the U.S. Federal Reserve adopted a pre-emptive tight bias monetary policy from the middle of 1999 until the middle of 2000 (Chart 9.2). This pre-emptive monetary policy was intended to maintain the sustainability of the U.S. economic expansion, which had been ongoing for eight years, without allowing sig-

nificant inflationary pressure to develop (a non-inflationary expansion).

However, from the fourth quarter of 2000 a number of economic indicators started to point toward a more rapid drop in domestic demand than had been anticipated. Investment and consumption started to weaken along with a decline of business and consumer confidence. Weakening of investment activity was partly reflected in a reduction of orders for durable goods, followed by a decline in manufacturing output. Weaker consumption was reflected in a drop in consumer confidence and retail sales. In the labor market, the economic slowdown was marked by a continuous rise in the number of claims for unemployment benefits. Credit ratings for a number of companies also started to decline due to bad debt.

During the reporting year, the inflation rate in the U.S. reached 3.4%. Low inflation despite rapid economic growth was a result of rising productivity and reflected increased use of information technology and telecommunications on a broad scale (Box: "The New Economy" and Federal Reserve Monetary Policy). The possibility of slower economic expansion, along with reduced inflationary pressure supported by continued productivity growth, caused the Federal Reserve to change its policy stance from tight bias to neutral bias, particularly after the middle of 2000. This ended the Federal Reserve's tight money cycle, which had been in place since

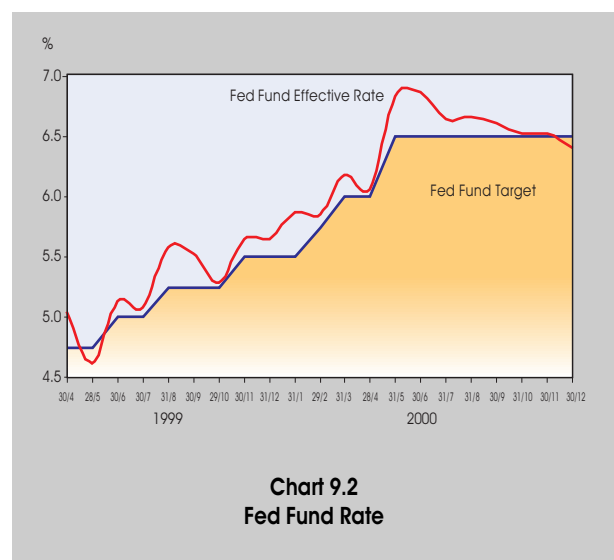
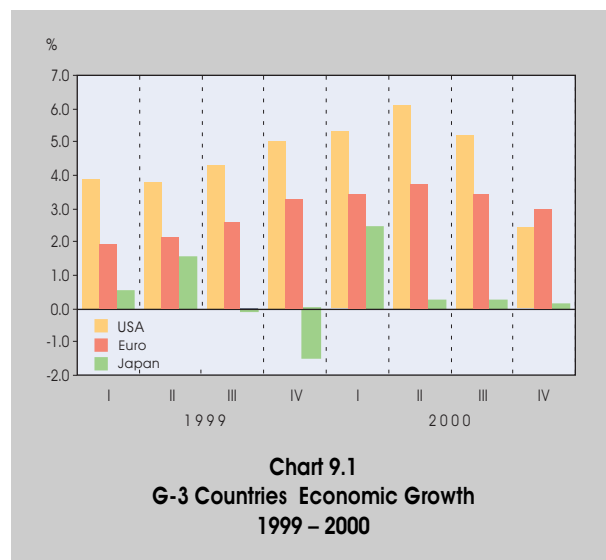

the second half of 1999 and had seen the Federal Fund interest rate rise from 4.8% to 6.5%.

During 2001, the Federal Reserve is expected to loosen its monetary policy stance in order to prevent a sharp contraction of the economy (a hard landing). However, chances for avoiding a hard landing also depend on the degree to which certain fundamental imbalances can be resolved, particularly the current account deficit and the growing private sector financial deficit. Financial markets have anticipated the possibility of a drop in economic activity, as reflected in falling stock prices and declining yields on long-term bonds.

Western Europe

During the reporting year, expansion of Western European economies, particularly those in the Euro zone, showed moderate signs of improvement. In 2000, Europe's economy was expected to grow by 3.4%, up from 2.3% in 1999. Economic expansion in 2000 was mainly due to improved performance in the external sector. Export performance of countries in the region improved in line with a rise in import demand from the U.S. and Asia. Aside from higher demand in importing countries, better export performance was also supported by the competitive value of the euro. From its launch in early January 1999, the value of the euro weakened by 26.0%. However, the weakening of the euro and the persistent rise of oil prices resulted in higher prices for imports, which created additional inflationary pressure. In 2000, the inflation rate reached 2.8%, breaching the upper limit set by the European Central Bank.

In the year 2000, the rise of oil prices and the weakening of the euro became two serious factors threatening the sustainability of economic expansion in the Euro zone. The combination of these two factors created broader problems. The first problem was the wage-price spiral. The rising cost of living from higher oil prices and the weakening of the euro encouraged labor unions to demand salary increase, which added to inflationary pressure. Second, the rise in oil prices and the depreciation of the euro worsened consumer confidence, which led to a drop in consumer spending. Third, ris-

ing costs and declining consumer demand forced companies that relied on the domestic market to start reducing production.

The European Central Bank responded to these developments with a tight bias monetary policy. To limit the depreciation of the euro, the benchmark interest rate (the refinancing rate) was increased from 3.0% to 4.75%. G-7 countries also undertook joint intervention in the foreign exchange market. During the third quarter of 2000 joint intervention undertaken by G-7 countries was unable to raise the value of the euro. Joint intervention did not begin to succeed until November 2000, when the euro strengthened to a level above \$0.90. Toward the end of the year, the tendency for the euro to strengthen and for oil prices to drop reduced pressure on the European Central Bank to raise interest rates. Consequently the benchmark short-term interest rate was kept at 4.75% until the end of the year.

Japan

Japan experienced a slow and fragile economic expansion. The main obstacle to Japanese economic growth was the slow pace of corporate and banking sector restructuring and the consequent credit crunch. A number of big companies faced bankruptcy and the banking system suffered from high levels of bad debt, which contributed to a worsening of bank balance sheets and slowed financial sector restructuring. This limited the ability of banks to provide new loans to the business sector, even though interest rates were maintained at very low levels (the lowest in the world). Toward the end of 2000 the Japanese economy began to slow as export performance, particularly exports to the United States, declined. Exports had been the main source of growth. This caused the trade surplus to drop. Fiscal activity, which in early 2000 had provided a significant stimulus for economic growth, started to lose momentum after the second quarter. The ability of fiscal activity to support economic growth was limited by the expansion of government debt to 130.0% of GDP (the highest level in advanced countries). The Japanese economy was expected to record a growth rate of 1.9% in 2000.

Asia (Excluding Japan)

Economic growth remained high in a number of Asian countries in 2000 (Chart 9.3). With strong growth in the United States, the export sector - including both electronics and non-electronic products - remained the main engine of growth in Asia. During the year, China, South Korea, Hong Kong, Singapore, Taiwan and Malaysia recorded economic growth rates of between 7.0% and 10.0%. During the early stage of economic recovery in 1998/1999, the fast growth of exports had stimulated increased investment and consumption, and the momentum of this growth continued through 2000.

Although world interest rates tended to increase in 2000, a number of Asian countries still maintained low interest rates, except Hong Kong which had adopted a currency board system and those Asian countries suffering from strong exchange rate depreciation. Thailand, Singapore, and Malaysia maintained low interest rates. The interest rate level in Thailand (1.5%) was the lowest in the world after Japan. The continued low interest rate was needed to maintain the momentum of economic recovery and restructuring of the banking and corporate sectors. On the other hand, interest rates in Indonesia and the Philippines tended to rise as a result of strong depreciation pressure on their currencies, mainly attributable to rising social and political tensions.

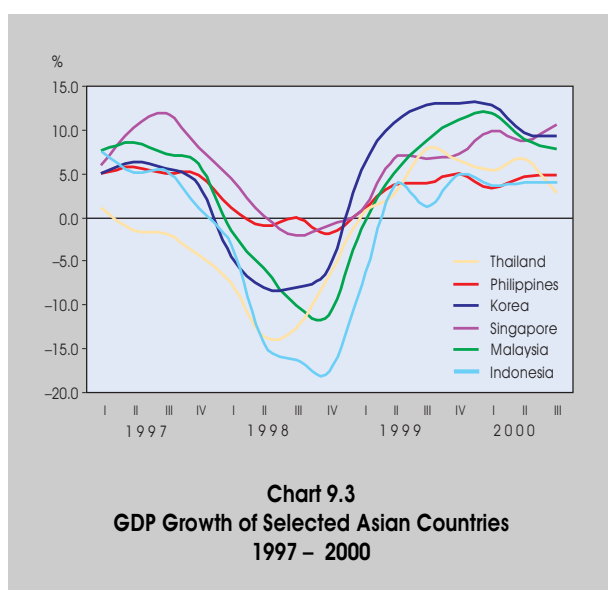

In the midst of fast economic growth in a number of Asian countries over the previous two years, structural reform in the region was not proceeding as expected. If not handled carefully, this could make regional economies susceptible to external shocks. Structural reform mainly involved the restructuring of corporate balance sheets. In a number of Asian countries, efforts to improve balance sheets in the corporate sector appeared to be overshadowed by the success story of recovery from the Asian economic crisis. As a result of the slow process of corporate and banking sector restructuring, asset quality in both sectors did not improve. The level of non-performing loans did not decline significantly. In a number of countries, this became an obstacle impeding the intermediation function of banks. With the expected slow growth of Asian economies in 2001, the challenge to the continuation of private sector restructuring is expected to become even more difficult.

South America

Economic conditions in Latin America were also improving, mainly due to stronger export performance and rising consumption. Mexico experienced the fastest growth in the region, with GDP growth expected to reach 7.0% in 2000, higher than the 3.5% growth rate recorded in 1999. The sustainability of economic expansion in Mexico following the economic crisis in 1994 was supported by prudent monetary policy, revenue from the rise of oil prices, the continuation of U.S. economic expansion (as the main export destination), along with continued growth of consumption and investment. To prevent the economy from overheating, monetary and fiscal policy began to be tightened from the second half of 2000.

The Brazilian economy was expected to record growth of 4.0% in 2000, after growing by 1.0% in 1999. On the supply side, the main source of growth came from the manufacturing sector. On demand side, the main contribution was from consumption, as a result of expansive fiscal policy.

The Chilean economy experienced a contraction of 1.1% in 1999 but was expected to record growth of 5.5% in 2000. The export sector became the main engine of economic growth with exports rising primarily as a result of increased pro-

duction of copper and higher copper prices in international markets.

Among large countries in South America, Argentina experienced economic stagnation in 2000, with growth estimated at just 0.5%. Nonetheless this marked an improvement relative to 1999 when the economy contracted by 3.3%. The slow process of economic recovery in Argentina resulted in very little growth of government revenue, which caused the budget deficit to grow to US\$1.5 billion in 2000 from US\$1.05 billion in 1999. Argentina was also faced with a high level of foreign debt. These two problems triggered speculation that the country could fall into a debt trap, causing an upheaval in financial markets. The IMF package for Argentina worth US\$39.7 billion temporarily limited fluctuation in the foreign exchange market, although many people still questioned Argentina's ability to finance its fiscal deficit and high foreign debt level over the next few years.

Africa and the Middle East

In a number of African countries and in the Middle East, economic development in 2000 was mostly supported by external factors, including rising commodity prices, particularly oil. Increased revenue as a result of a persistent rise in oil prices during 1999 and 2000 has increased consumer and business confidence, which stimulated investment and consumption activities. Improved economic conditions in a number of countries in these two regions was also related to the success of the economic restructuring process, which began to be implemented several years ago, although it had not yet been implemented on a broad scale.

The South African economy was expected to grow by 3.0% in 2000, after recording growth of 1.2% in 1999. As the biggest economic power in Africa, growth in South Africa had a positive impact on other countries in the region. However, a number of African countries that are less well endowed with natural resources still encountered challenges in increasing their people's welfare.

Countries in the Middle East, such as Saudi Arabia, Egypt, Iran and Kuwait, were expected to record economic growth

of between 3.0% to 5.0% mainly due to higher revenue from oil exports. Looking at the structure of the economy in Africa and the Middle East, economic performance in both regions in coming years could be very vulnerable to the fluctuation of international commodity prices, which tend to be highly volatile.

Foreign Exchange Market

The U.S. dollar strengthened in global currency markets in 2000 (Chart 9.4). The strengthening of the dollar relative to the yen and the euro was mainly due to portfolio capital flows from Japan and Europe to the United States. These capital flows were a response by international investors to more rapid growth of the United States economy than the Japanese and European economies, and to the growing gap between U.S. dollar interest rates and yen and euro interest rates. However, toward the end of 2000 the dollar began to weaken relative to the euro as indications grew that U.S. economic growth might slow.

The dollar continued to strengthen against the yen until the end of 2000 due to rising negative sentiment caused by the slow pace of the Japanese economic recovery and growing political problems. With the weakening of the yen, a number of other Asian currencies suffered a sharp depreciation. In addition to the global strengthening of the U.S. dollar, internal

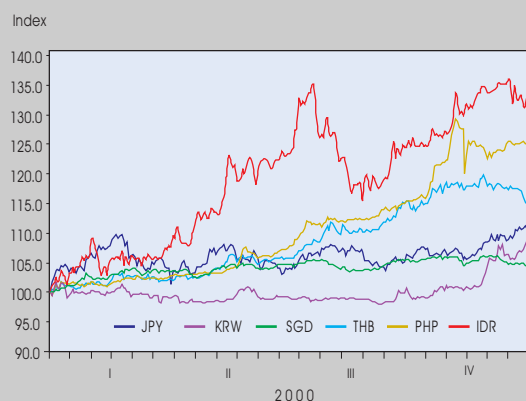

Chart 9.4
Asian Countries Nominal Exchange Rate Index
(3 Jan 2000 = 100)

factors, such as protracted social or political problems in a number of countries, including Indonesia, the Philippines, Thailand and Taiwan, created negative sentiment with respect to the currencies of these countries.

Capital Market

World stock prices were on a downward trend in 2000 (Chart 9.5). The price of information technology and telecommunication stocks (IT), which had risen sharply in the early part of the year, began to drop in the second half of 2000, as reflected in sharp fluctuations of the Nasdaq index. Declining stock prices in the United States in the second half of 2000 were mainly due to the rise in oil prices, high interest rates and expectations of declining revenue as a result of a slow down in the global economy. The drop in the Nasdaq index had an impact on Asian markets, particularly countries that produced IT products such as South Korea, Taiwan and Singapore. Stock prices in Japan also declined sharply, triggered by worsening sentiment regarding Japan's economic prospects in response to the bankruptcy of a number of large companies and to political events, particularly toward the end of the year.

International Cooperation

Economic cooperation during 2000 on preventing a repetition of economic crisis, on stimulating the economic recovery pro-

cess in various countries and on enhancing the capacity of international institutions to help member countries recover more rapidly from crisis situations. As part of this cooperative effort, Indonesia obtained assistance from friendly countries and international institutions to accelerate the economic recovery process, and also took part in discussions and research carried out by various international organizations.

Cooperation in the monetary sector, finance and banking was directed toward the development of an international financial architecture as a central theme. Development of an international financial architecture during the reporting year started to move from conceptual issues to more concrete issues, and to the possibility of implementation. A number of pilot projects were launched in 2000, including the formation of expert groups, commitments to implement international standards and codes, developing guidelines for prudential financial practices, and studies on implementation of standstills as a way to increase the involvement of the private sector in handling crisis situations.

The focus of development cooperation covered poverty elimination and the provision of loan facilities. During the reporting year, the World Bank actively encouraged partnerships and other methods to increase its capacity to help poor countries. The Asian Development Bank facilitated the commitment of member countries in providing loans for the social sector by raising funding for the Asian Development Fund.

Cooperation at the regional level articulated a commitment to reform the international financial system and the economic recovery process, and to create the capacity to provide short-term liquidity assistance to member nations. The APEC forum agreed that member countries would step up efforts to develop a strong foundation to encourage sustainable growth and liberalization of trade and investment. The ASEAN forum, together with China, Japan and South Korea, agreed to expand the ASEAN Swap Arrangement (ASA) to provide short-term liquidity assistance to member countries, and to establish a bilateral swap arrangement facility (BSA).

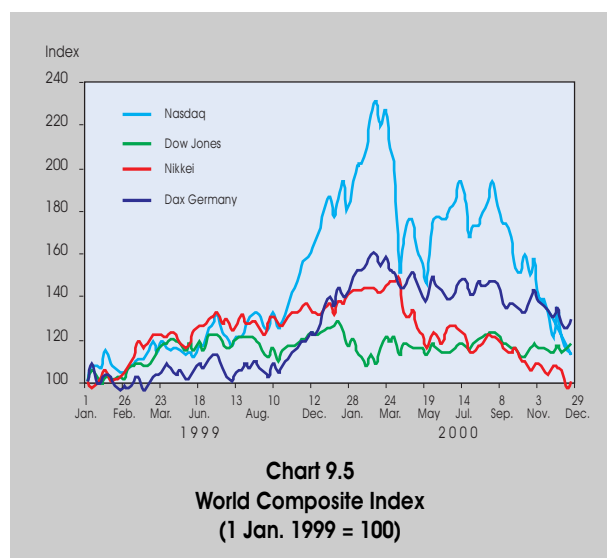

Cooperation in Monetary, Financial and Banking Issues

The International Monetary Fund (IMF)

During 2000, issues discussed by the IMF included: (1) efforts to strengthen the international financial system that would include a role for the IMF in the future; (ii) a review of IMF financing facilities; (iii) increasing surveillance and transparency in the financial sector as well as involvement of the private sector in handling crises; (iv) establishment of an independent evaluation office; and (v) a poverty reduction growth facility.

As part of efforts to strengthen the international financial system, the IMF and the international community sought ways to reduce vulnerability, to avoid crises, and to minimize the domino effect when a crisis occurs. The IMF plays a central role in unifying efforts to strengthen the international financial system by maintaining cooperation with other international institutions and encouraging macroeconomic and international financial stability, along with growth of member countries.

In relation to financing facilities, the IMF undertook a review of facilities and policies in relation to facility aspects of the IMF. The review of IMF facilities covered the repurchase period, the level for stand-by arrangements (SBA) and extended fund facilities (EFF), the utilization of contingent credit lines (CCL) and implementation of post program monitoring. Policies regarding the period and price structure of IMF facilities were also reviewed. It is hoped that this will encourage members to accelerate repayment and avoid long term use of SBA and EFF facilities.

Efforts to improve surveillance and transparency in the financial sector are needed to identify susceptibility and anticipate threats to the financial stability of member countries. Efforts to improve surveillance are supported by availability of data and the use of international standards for evaluation. Efforts to improve transparency were undertaken through the implementation of a general policy for Article IV Consultation.

Regarding the need for debt restructuring or debt reduction, a Committee has agreed that IMF assistance programs must be directed at medium-term sustainability and maintaining balance between the contribution of private

external creditors and official external creditors in the case of financing from international financial institutions. As an element of surveillance, the IMF has adopted adjustment via changes in the global economy and strengthening key areas such as the financial sector, foreign debt and development of the balance of payments. Furthermore, the IMF will also pay more attention to financial susceptibility, and will support analysis of the level of susceptibility in its surveillance by way of: (i) stimulating further development and integration of indicators of the level of financial susceptibility for each country in IMF surveillance; (ii) cooperate with the World Bank in finalizing guidelines on sovereign debt management; and (iii) ask the IMF Executive Board to make additional efforts to find ways to include official reserves in surveillance and to provide technical assistance. It was agreed that efforts to involve the private sector in the management and prevention of crises would use a voluntary approach and market-oriented solutions.

To improve educational programs at the IMF, to strengthen the external credibility of the IMF, to improve understanding of the IMF work framework in all member countries, and to support the leadership and responsibility of the Executive Board, the IMF agreed to form an Independent Evaluation Office (EVO) which is expected to begin operating prior to the International Monetary Financial Committee (IMFC) meeting in Spring 2001.

In an effort to strengthen the international financial system, the IMF has undertaken evaluation and development of a program for poverty eradication and debt reduction for poor countries. During 2000, the IMF developed country-owned poverty reduction strategies related to the extension of debt relief that will serve as reference points for the IMF and World Bank in the extension of concessional lending. Within the framework of the Highly Indebted Poor Countries (HIPC) Initiative, the IMF and the World Bank are seeking ways for 20 countries to reach an agreement at the end of 2000 and make efforts to ensure that debt relief will always be available to support growth and poverty eradication. Five countries have reached an agreement already.

In addition, as part of the IMF loan program, the Indonesian government during 2000 signed three letters of intent (LoI) and Memorandum of Economic and Financial Policies (MEFP), on January 20, May 7 and September 7.

In January 2000, the government asked the IMF to provide a New Extended Fund Facility, which will replace and cancel the old Extended Fund Facility agreed to on August 25, 1998. With the approval of this request, the EFF value available for the Indonesian government increased from SDR9,052,240,000 to SDR11,104,820,000. Between January and December 2000, Indonesia made purchases from the EFF worth SDR851,150,000, bringing purchases of SBA and EFF executed as of December 2000 to SDR8,317,970,000. The EFF value still available until November 2002 comes to SDR2,786,850,000.

G-20

During the reporting year topics discussed by G-20 countries covered globalization and efforts to reduce the vulnerability of the global financial system.

G-20 countries highlighted their confidence that economic integration can continue to serve as a powerful force enhancing people's welfare by facilitating access to capital, goods and knowledge. However globalization can cause economic difficulties and social dislocation. Consequently, governments play an important role in formulating and implementing policies to minimize the risks associated with globalization.

Efforts to reduce the vulnerability of the financial system can be carried out by implementing appropriate policies in the areas of: (i) selecting the appropriate exchange rate regime; (ii) management of foreign debt, (iii) systematic approaches to involvement of the private sector in preventing development crises; and (iv) implementation of standards and codes.

The selection of the exchange rate regime must be accompanied by appropriate macroeconomic policies and a strong financial system, and the selection can not always be implemented with the same results in different countries. The trend in many countries is to implement an appropriate exchange rate regime (preferring a floating exchange rate) for

stability of the financial system. It was agreed that whatever system is implemented, each country must avoid intervention that aims to maintain an unsustainable exchange rate level.

Prudent management of foreign debt requires an appropriate balance between minimizing costs and raising liquidity, avoiding excessive reliance on short-term debt, and currency mismatch, along with the development of an efficient and liquid long-term debt market for government bonds. In relation to foreign debt management, G-20 countries support efforts being undertaken by the IMF to prepare guidelines for public debt management and debt-reserve related indicators.

In relation to private sector involvement in resolving and preventing economic crises, there is need for a framework for private sector involvement through creation of a more stable and efficient money and capital market, implemented flexibly. Other efforts to involve the private sector can be carried out through improved dialog between government and the private sector and by developing principles of equal treatment with creditors.

In the case of implementation of international standards and codes (codes), it was agreed that: (i) G-20 countries need to articulate their commitment in implementing codes; (ii) the public sector need to continue dialogue with the private sector to get private sector input on priorities which must be carried out by countries as well as by the international community in implementing codes; (iii) the IMF is responsible for carrying out surveillance of the implementation of codes of member countries, and (iv) governments and the international community must cooperate to guarantee availability of human resources and financing for member countries for implementing the codes.

The Manila Framework

During 2000, issues that were discussed under the Manila Framework included; (i) financial sector restructuring; and (ii) the acceptable level of international foreign exchange reserves. In relation to financial sector restructuring, rapid development was achieved by Malaysia, followed by Korea, as seen by vari-

ous indicators such as non-performing loans (NPLs) and progress in corporate restructuring, as well as asset sales. However, Indonesia has yet to show significant improvement in financial sector restructuring. The IMF, the World Bank and the Asian Development Bank (ADB) are of the view that financial sector restructuring will not succeed without success in corporate sector restructuring.

Regarding the appropriate level of foreign exchange reserves to support economic stability and to avoid a crisis, the Manila Framework forum expressed the view that the appropriate level of foreign exchange reserves will vary between countries, depending on the exchange rate regime, the amount of short-term debt, and the soundness of the financial system.

For the next meeting of the Manila Framework, the forum agreed to again discuss the plan raised at the first Manila Framework meeting in November 1997 to establish financial cooperation. Indonesia was one of several countries that were asked to contribute to the preparation of a background paper.

Central Bank Cooperation

During the reporting period, Bank Indonesia increased its cooperation with other central banks. Cooperation was undertaken through the Executive Meeting of East Asian and Pacific Central Banks (EMEAP), South East Asia, New Zealand and Australian Central Bank (SEANZA), and South East Asian Central Bank (SEACEN).

The EMEAP forum focused its attention in 2000 on three issues: (i) private sector participation; (ii) highly leveraged institutions (HLI) and (iii) capital flows. With regard to increasing private sector participation, EMEAP countries were still divided into two different views. Some EMEAP members agreed on a case-by-case approach and other members agreed on implementation of a common framework. To solve the negative impact of HLI's on the international financial system, the HLI Working Group recommended strengthening HLI risk management practices and counterparts, improving public disclosure and establishing financial market infrastructure.

In the discussion on capital flows, there was a general view that a number of countries experienced economic instability as the result of a sudden reversal of capital flows during the currency crisis in Asia. In order to address this problem, a number of countries implemented capital controls in the form of market-based restrictions. In relation to the exchange rate regime, the system adopted must be in line with the economic conditions of each country and implemented together with consistent macroeconomic policies. Meanwhile, in order to strengthen the financial system, there is a need to strengthen prudential regulations and to improve efficiency of the financial system, as well as to strengthen cooperation as part of the effort to achieve stable growth and prevent future crises.

SEACEN, as an institution that undertakes research and training for South East Asian central banks, held several meetings in 2000. Meetings included an international dialogue on capital flow issues as a follow-up agreement of SEACEN Central Bank governors. Central banks and monetary authorities of SEACEN members strongly agreed to support international efforts to increase capital flow stability by establishing a SEACEN Expert Group (SEG) on Capital Flows. The aims of the SEG are to (i) prepare concrete and practical proposals for ways in which SEG members can individually and collectively improve control over capital flows; (ii) implement related issues with SEG members in international organizations.

During a symposium within the framework of SEANZA, independence of central banks was discussed, covering experience of the Central Bank of England (BOE) in the implementation of the independence principle, particularly after implementation of the new BOE Act in 1998. BOE stressed that independence must be supported by officials that have integrity, objectivity and competency. The Bank Indonesia delegation said at that occasion that Indonesia's experience in the last 15 months since the implementation of Act Number 23 of 1999 proved the need for an adjustment by all parties, both the government, parliament, businesses, and the community, so that the independence principle stated in the Act can be implemented consistently, particularly given the fast changing political situation and government. This view received a

positive response and moral support from the BOE governor and leaders of the central bank delegations.

Cooperation in Development

The World Bank

The main topics discussed by the World Bank in 2000 included: (i) intensification of efforts to address HIV/AIDS; (ii) reducing poverty and global public goods; (iii) a comprehensive development framework (CDF); and (iv) renewing the financial capacity of the IBRD.

The Development Committee voiced the need for intensive action at an international level to prevent the HIV/AIDS epidemic and care for the victims. The spread of the disease may weaken economic growth, human capital and worker productivity.

As part of efforts to eliminate poverty, the World Bank is involved in providing global public goods. Involvement is needed because: (i) it provides added value to the development goals of the World Bank; (ii) it stimulates other sources and increases partnership; (iii) it provides a comparative advantage for the World Bank; and (iv) global action is required. The involvement of the World Bank in providing public goods was realized in the form of increasing cooperation with international institutions, facilitating the flow of goods, services and other productive factors internationally, widening the benefits of globalization and preventing economic and social problems, maintaining and protecting the environment, and developing skills related to development.

As part of efforts to reduce the burden of poor countries, during the reporting year there were five countries, including Bolivia, Mauritania, Mozambique, Tanzania and Uganda, that reached decisions on debt write-off as part of HIPC initiatives worth US\$14 billion. During the year the IMF and World Bank also considered another 15 countries that might be eligible to receive a reduction of foreign debt.

As part of the effort to develop and prepare a more comprehensive strategy for reducing poverty in low-income countries, the development committee encouraged the IMF and the World Bank to allocate sufficient resources to support

programs to eliminate poverty through continuing cooperation with member countries. To support this objective, advanced countries need to increase market access for export products of developing countries and to pay attention to the potential of regional integration to help developing countries increase their market shares in the world market. Expansion of integrated trade is needed within the framework of comprehensive development, which covers reform, institutional investment, infrastructure and social programs.

The review of the World Bank report on the financial capacity of the IBRD reveals the increase in demand for World Bank assistance. The limited financial capability of the World Bank raised concerns about its ability to meet this demand. The Executive Board requested a review of the possibility of increasing the financial capacity of the World Bank.

The Asian Development Bank (ADB)

Cooperation between Asian countries through the Asian Development Bank resulted in several commitments, including recognition that: (i) in the globalization era, emerging markets must continuously seek ways to accelerate economic development by engaging different social groups in broad scale poverty alleviation efforts; (ii) in the framework of equal access to social sector loans, particularly for poverty alleviation, member countries support an increase in the Asian Development Fund. In connection with the ADB's commitment to provide long term loans, Indonesia received loans amounting to US\$564.7 million in 2000.

Regional Cooperation

Asia Pacific Economic Cooperation

During the reporting year, various meetings were undertaken within the framework of APEC. The meetings discussed economic cooperation among member countries. Meetings were undertaken at the ministerial, head of government, and finance ministry level.

The ministerial level discussed main APEC 2000 topics, including: (i) Building Stronger Foundations; (ii) Creating New Opportunities; and (iii) Making APEC Matters More. In relation

to the theme of Building Stronger Foundations, APEC has achieved progress in promoting trade and investment liberalization, such as by disseminating information through the Web, widening Collective Action Plans in the form of paperless trading connected with tax procedures and efforts to implement WTO agreements through increased capacity building.

The finance ministers meeting also talked about cooperation between APEC member countries to strengthen financial systems through reform of the international financial architecture. Various concrete steps have been taken to identify sources of vulnerability, to increase the elasticity of domestic and international markets, and to improve the general performance of financial markets. These steps include efforts to implement international standards and codes in the APEC region and to increase surveillance activity as an important element in encouraging strengthening of domestic and international economy. To strengthen financial systems, APEC welcomes efforts to increase private sector participation in addressing crises, to modify IMF loan facilities, to improve financial cooperation at the regional level as a complement to IMF loans, and to reduce sensitivity to crises in line with the results of the G-20 meeting.

Regarding international standards and codes APEC supports key standards identified by the Financial Stability Forum (FSF) and efforts of APEC member countries to implement these codes as a top priority. APEC has made progress in developing international standards, codes and best practice guidelines in a broad context that will help efforts to improve legal frameworks, institutions and arrangements in APEC economies. Implementation of FSF recommendations on HLI, capital flows and Offshore Financial Centers (OFC) will help reduce risks created by cross-border capital flows and will enhance international financial stability.

To strengthen financial systems in APEC countries, APEC member economies have developed various initiatives including a Voluntary Action Plan and More Stable Capital Flows, a study on Managing Bank Failure, developing the capacity of financial regulators and the supervision system, increased corporate governance, social safety nets, legal frameworks and

regulations on how to combat criminal activity in the financial sector, a review of Credit Rating Agencies, and initiatives related to financial transactions using electronic instruments.

Regarding the Voluntary Action Plan (VAP), APEC economies have stressed the importance of APEC focusing its efforts on strengthening and increasing policy credibility to minimize risks and utilize benefits in international capital markets. Regarding liberalization of capital accounts, the importance of efforts to strengthen financial systems and an effective risk management framework was stressed. In relation to the Policy Dialogue Process, the Voluntary Action Plan Group Meeting in principle has agreed to the Basel Committee's Core Principles for Effective Banking Supervision as a topic to be discussed during 2001. The Policy Dialogue Process is one of the components of the VAP Initiative Part II, a process in which APEC member economies exchange views on policy issues concerning implementation of international standards to strengthen financial markets in the APEC region.

To strengthen domestic financial markets, the study on Managing Bank Failure will focus on bank management during crises and on policy responses needed to prevent systemic failure. With regard to creating an efficient and trustworthy Credit Rating Agency, APEC members can play an active role by raising quality and improving corporate governance.

To reduce risks and prevent crises, APEC has undertaken a review on implementation of social safety net programs in various APEC members, covering; (i) better planning for pre-crisis safety nets; (ii) accuracy of information on vulnerable and poor countries; and (iii) the need for broader instruments to guarantee coverage and to reach target groups. Implementation of the program needs to be coordinated among government institutions so that there will be no overlapping of responsibilities, which would add to the administrative burden.

ASEAN

In the year 2000, cooperation among ASEAN central banks resulted in an agreement that ASEAN member countries still wanted the ASEAN Central Bank Forum (ACBF) to be maintained in its current form without involving the ASEAN Secre-

tariat in the dialogue. It was agreed that the ACBF is a forum for the exchange of information between central banks.

During the reporting year, ASEAN member countries agreed to modify the Asean Swap Arrangement (ASA). The goal of the new Asean Swap Arrangement is to provide short-term foreign exchange liquidity assistance to members facing balance of payment difficulties and to increase financial cooperation among ASEAN countries. The ASA Working Group led by Bank Indonesia agreed to the following ASA requirements: (i) countries participating in ASA were increased from five countries to all ten ASEAN members; (ii) the maturity date and extension of the ASA was made more flexible, but it may not exceed six months; (iii) the cooling off period for requests to draw on the facility was extended from one month to six months; (iv) the total ASA facility was increased from US\$200 million to US\$1 billion, with contributions coming from two groups. Group I will include Indonesia, Malaysia, the Philippines, Singapore, Thailand, and Brunei Darussalam and will contribute US\$900 million, or US\$150 million each. Contributions from Group II will total USD100 million, with Cambodia contributing US\$17 million, Laos contributing US\$5 million, Vietnam contributing US\$50 million, and Myanmar contributing US\$428 million; (v) the pre-condition for using the New ASA is that the country is either under an IMF program or its net foreign exchange reserves have declined sharply to the point where they could cover three months worth of imports; and (vi) currencies used are the US\$, yen, and euro; interest rates are LIBOR, Euro Yen, and Euro LIBOR. With the existing ASA expiring on 4 August 2000, ASA members have agreed that Malaysia will act as the agent bank.

Cooperation between the ASEAN + 3 has also resulted in an agreement to provide a bilateral swap facility and re-

purchase agreement (BSA) between ASEAN countries and Japan, China and South Korea. The BSA is aimed at providing short-term financial assistance in the form of a swap to countries that participated in the Chiang Mai Initiative to support balance of payments. The swap constitutes an addition to existing facilities provided by international financial institutions, including assistance from the IMF and the ASA. As a general guideline, the principles of the BSA are (i) the BSA is not related to the ASA, but is instead an independent facility that can be carried out in parallel with the ASA; (ii) BSA facilities can be used by all member countries and have no connection with the IMF; (iii) interest rates are LIBOR +150 basis points (bp) to withdraw and for the first extension, with an additional 50 bp for each two period extension. The BSA facility has not yet been established as there are still several issues to resolve, including government guarantees on BSA facilities and the maximum limit of the facility, which is currently unclear.

Other ASEAN cooperation measures agreed to include the establishment of a working group on an ASEAN Currency and Exchange Rate Regime. The formation of the working group was a follow-up plan to the proposal for an ASEAN common currency and exchange rate, raised at the ASEAN Summit in 1998 in Hanoi under the Hanoi Action Plan. As head of the working group during the reporting period, Malaysia has presented terms of reference for reviewing the costs and benefits of establishing a common currency for all ASEAN member countries. This ASEAN project received technical assistance from the IMF and is intended to: (i) increase financial and social stability, particularly at the regional level; (ii) prevent financial crises in the future, and (iii) improve regional cooperation in the financial sector.

Box : “The New Economy” and Federal Reserve Monetary Policy

The fast growth of the United States economy over the past eight years, which has been accompanied by a continuous rise in productivity growth, indicates that fundamental changes have been taking place in the United States economy (Chart 1.2). Many economists share the view that this rapid growth of productivity has been due to rapid growth in the computer and information technology sector and the growing use of this new technology in other sectors of the economy, giving rise to the phenomenon known as “the new economy.”

Rapid diffusion of computer and information technology can be related to productivity growth in three ways:

- ◆ Direct productivity gains in industries that produce information technology products has broad implications for productivity in all economic sectors. Productivity growth in the information technology sector causes the price of computers and related equipment to drop sharply. This encourages other industries to use computers and related equipment more intensively.
- ◆ Capital deepening in the financial market results in an increase in the capital-labor ratio in various industries. With more investment in computer hardware and information technology, labor productivity rises. The utilization of computers raises efficiency and speed in the production process and minimizes the use of inputs.
- ◆ Spillover effects happen when benefits obtained by producers from an investment rise, encouraging other producers to carry out the same investment. Spillover effects become more intense with the rise of investment and information technology. Benefits obtained from investment in the “internet capable computer” rise when more and more consumers and businesses use internet services.

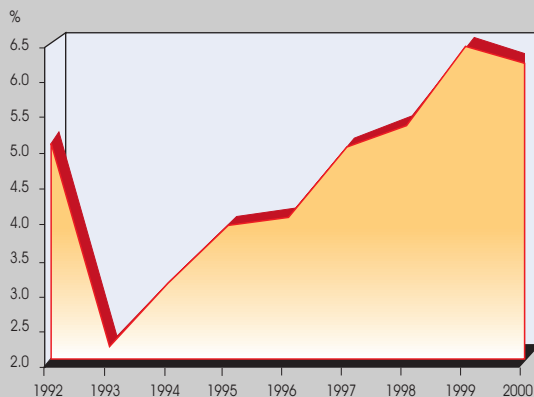

Chart 1.
USA Productivity Growth 1992-2000

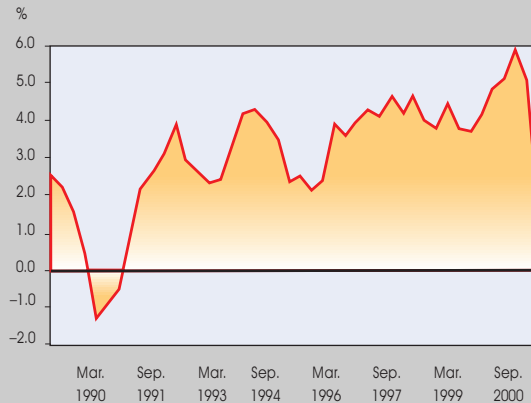

Chart 2.
USA Economic Growth 1992-2000

ers to carry out the same investment. Spillover effects become more intense with the rise of investment and information technology. Benefits obtained from investment in the “internet capable computer” rise when more and more consumers and businesses use internet services.

Various studies have measured the contribution of information technology to productivity growth. For each one percent increase in the growth rate of productivity in the United States, between 44% and 73% of the increase is due to the use of information technology.¹⁾ A number of industrialized economies, including newly industrialized Asian countries, have experienced high productivity mainly through capital deepening and the contribution to total factor productivity (TFP).²⁾ Such countries invested of at least 5.0% of GDP in information technology hardware.

Large scale investment in IT products in the United States has resulted in structural change in the economy, leading to a persistent rise in productivity that has raised the potential

1) Research conducted by Dale Jorgenson and Kenin Stiroh, Raising the Speed Limit: U.S. Economic growth in the Information Technology Age, (period 1990-1998). Also Steven D. Oliner and Daniel E. Sichel, The Resurgence of Growth in the Late 1990s (period 1990-1999) and Karl Whelan, Computers, Obsolescence, and Productivity (period 1974-1998).
2) In the "Sollow Growth Model", TFP is residual reflecting spillover effect

output of the United States economy. Up through the mid-1990s, the potential output of the United States economy was only about 2.5%. In 2000, a number of economists predicted that the potential output of U.S. economy had reached 3.5% to 4.5%. As a result, the output gap in the economy did not cause inflationary pressure even though domestic demand rose sharply. Low inflationary pressure can also be explained from a micro point of view. With increasing economic activity, the demand for labor rises steadily which results in a tight labor market and puts upward pressure on wages and salaries. However, with productivity rising, higher wages and salaries are offset by lower production costs per unit of output, and consequently there is no reason for producers to raise prices.

The structural change in the economy is one reason why a number of economic indicators, such as the NAIRU (Non-accelerating inflation rate of unemployment), which one decade ago was often used by the Federal Reserve in formulating its monetary policy, are now less reliable. For instance, fast economic growth has absorbed labor therefore reducing the unemployment rate. The NAIRU, which was often used by economists to measure the lowest level of unemployment

that would not cause prices to rise, had already declined to 5.0%. Although the unemployment rate fell to 3.9% in 2001 — the lowest unemployment rate in 30 years — this did not cause inflationary pressure. For this reason, over the past few years the formulation of monetary policy has been based on information variables obtained from the real sector, particularly leading economic indicators that provide information about the future direction of economic activity. Such economic indicators include factory order in upstream industries, consumer and business confidence, weekly unemployment claims, business inventories, the productivity index, and other measures. Given the size of the wealth effect that stock prices have on private consumption, the Federal Reserve also pays attention to capital market indicators such as equity prices. The availability of these leading economic indicators helps the Federal Reserve carry out a pre-emptive monetary policy.

In brief, the emergence of “the new economy” in the United States and The Federal Reserve’s pre-emptive monetary policy can explain why the country’s economy experienced high economic growth in a sustainable way over the past eight years without significant inflationary pressure (a non-inflationary expansion).

Bab 10 *Economic Prospects and Policy Directions in 2001*



Chapter 10

Economic Prospects and Policy Directions in 2001

Indonesia's economy is expected to continue to recover in 2001. Given the current strong economic recovery process and with the assumption that risk and uncertainty factors will be brought under control, economic growth in 2001 is projected to reach 4.5% to 5.5%. Growth will be driven by exports, increase in investment activity and strong public consumption. Internal factors that will contribute to strong economic growth include several important issues such as bank and corporate debt restructuring, which is expected to proceed gradually. External factors, such as the condition of global economy, inflation, interest rates and oil prices, are expected to remain conducive for the growth of foreign trade and for capital flows to Indonesia.

Nevertheless, there are several risk factors and uncertainties that are expected to continue to affect the exchange rate in 2001. Downward pressure on the rupiah may still be felt, although in general the currency is expected to appreciate to between Rp7,750 – Rp8,250 per US dollar in 2001. Appreciation will be triggered by improvement of Indonesia's economic fundamentals in 2001 and by slow appreciation of the US dollar relative to global currencies due to the slowing of the US economy.

Looking at trends, inflationary pressure in 2001 is expected to remain relatively high as a result of inflationary expectations, increased capacity utilization and strong demand. In addition, the government's plans to increase oil prices, the floor price of unhulled rice, cigarette excises, civil servant salaries and regional minimum wages (UMR) are expected to influence prices. In addition, it is feared that the implementation of regional autonomy in 2001 could trigger inflation, especially if the regions introduce new taxes and levies.

Given the macroeconomic prospects and taking into account price changes that could be triggered by monetary policy, Bank Indonesia has set the inflation rate for 2001 at 4.0% to 6.0%, excluding the impact of the government's price and

incomes policy. The government's price and incomes policy is expected to add an additional 2.0% to 2.5% to the inflation rate over and above the target. To achieve the inflation target, Bank Indonesia will control the growth of base money in accordance with needs of the economy. To accomplish this, Bank Indonesia has set a target for base money growth of between 11.0% – 12.0% by end of 2001.

With strong pressure on the inflation rate and on the exchange rate, a tight bias monetary policy will still be needed in 2001, at least through the first semester. If inflationary pressures ease and the intermediation function of the banking system recovers, there will be room to relax monetary policy. Volatility of the exchange rate will be prevented. Efforts will be made to stabilise the rupiah by sterilizing the impact of government expenditure financed from off-shore revenues. Options will remain open to implement other measures that have a direct impact on the exchange rate, such as monitoring and regulating foreign exchange transactions and limiting the internationalization of the rupiah.

Growth prospects in 2001 and the probability of meeting the exchange rate target will depend on the handling of certain fundamental problems and on efforts to minimize risk and uncertainty. These problems include restructuring private corporate debt, restoring the intermediation function of the banking system, relieving pressure on the state budget, and ensuring the smooth implementation of regional autonomy. Various non-economic factors, particularly political issues, security, and legal uncertainty, could pose a serious threat to economic recovery, to the banking sector, to exchange rate stability and to price stability.

Global Economic Prospects

Economic Growth and World Trade

Global economic growth in 2001 is expected to reach 4.2%, down from 4.7% in 2000. In line with slower economic growth,

world trade volume is expected to grow by 7.8%, down from 10.0% in 2000. (Table 10.1).

The main factor contributing to economic growth in 2001 is expected to be productivity growth resulting from increasing use of sophisticated technology. Negative factors, on the other hand, stem from rising energy costs and a diminished residual impact from rapid economic growth in the previous two years.

Slower economic growth is expected in North America and in most European countries, caused by lower consumption, especially consumption of durable goods. Japan's economy is projected to improve following successful bank-restructuring and mergers. This situation is expected to have a positive influence on the investment climate and on exports from Japanese subsidiaries and joint-venture companies in Indonesia.

Economic growth in developed countries is expected to reach 3.2% in 2001, down from 4.2% in 2000. An economic slowdown is expected to take place in the USA with growth dropping from 5.2% in 2000 to 3.2% in 2001. A downturn is also expected to take place in European Union countries with growth dropping from 3.5% in 2000 to 3.4% in 2001. The Japanese economy is expected to grow by 1.8% in 2001, driven mainly by successful restructuring of the banking sector and businesses. The slow growth of developed economies will also reduce economic growth in developing countries, especially

certain Asian countries. Economic growth in some Asian countries in 2000 received a strong boost from export growth, especially electronics exports to developed countries, including North America. Given the less favorable world economic outlook for 2001, the economies of Indonesia's trading partners are expected to slow somewhat in 2001.

Inflation and international interest rates

World inflation is expected to decline in 2001 along with falling oil prices and slower world economic growth. Both developed and developing economies are expected to experience lower inflation. The US inflation rate is expected to fall to 2.6% (Table 10.2), and Japan inflation is expected to rise to 0.5% from deflation in 2000. Inflation rates in developing countries are expected to fall to 5.2% on average from 6.2% in 2000. Inflation rates in transition economies are expected to average 12.5%.

Relative price stability will lead developed countries either to reduce interest rates or to leave them unchanged. In the United States it is generally assumed that the tight monetary policy stance introduced by the Federal Reserve in 1999 has come to an end, with emphasis now shifting to policies to avoid an economic slowdown or recession. Stable world interest rates and improved economic conditions in crisis-hit Asian countries are expected to encourage a relocation of funds by investors to the Asian market. The access of crisis-hit countries to the international market is also projected to improve as a result of higher credit ratings.

Item	1999	2000**	2001 ¹⁾
Economic Growth (%)			
World	3.4	4.7	4.2
Industrial countries	3.2	4.2	3.2
Developing countries	3.8	5.6	5.7
Countries in transition	2.4	4.9	4.1
United States of America	4.2	5.2	3.2
Japan	0.2	1.4	1.8
Euro Countries	1.6	2.9	3.3
United Kingdom	1.4	3.1	3.0
France	1.6	2.9	3.3
China	7.1	7.5	7.3
South Korea	10.7	8.8	6.5
Singapore	5.4	7.9	5.9
World Trade Volume (%)	5.1	10.0	7.8

1) Projection
Source : World Economic Outlook, October 2000

International Commodity Prices

International commodity prices have moved in different directions since the Asian economic crisis. The price of oil is still high, while the prices of agriculture products are low. Oil prices are expected to fall in 2001 by 11.0%–13.0% (Chart 10.1), while the prices of metals and minerals are expected to increase by 1.5% and prices of agricultural commodities are projected to rise by 4.0%.

Following the OPEC price agreement on October 1, 2000, the price of oil is expected to fall gradually by \$3-\$4 per

Table 10.2
Inflation and International Interest rate

Item	1999	2000**	2001 ¹⁾
Inflation Rate (%)			
Industrial countries	1.4	2.3	2.1
Developing countries	6.6	6.2	5.2
Countries in transition	43.8	18.3	12.5
Short-term interest rate (%)			
United States of America	4.8	6.1	6.7
Japan	0.0	0.2	0.5
Euro countries	2.9	4.4	5.1

1) Projection
Source : World Economic Outlook, October 2000

barrel. The pricing mechanism agreed by OPEC members allows members to boost production if OPEC's price brackets surpass the agreed ceiling price for 20 consecutive days. However, if the price of oil is below the floor price, the production quota is reduced automatically. In light of this agreement and given the accumulation of stocks due to relatively low winter demand, the price of oil is expected to be between \$24 and \$25 per barrel.

Prices of Indonesia's non-oil and gas export products are projected to be relatively stable in 2001, with some tendency to rise, which will provide a positive incentive to producers to

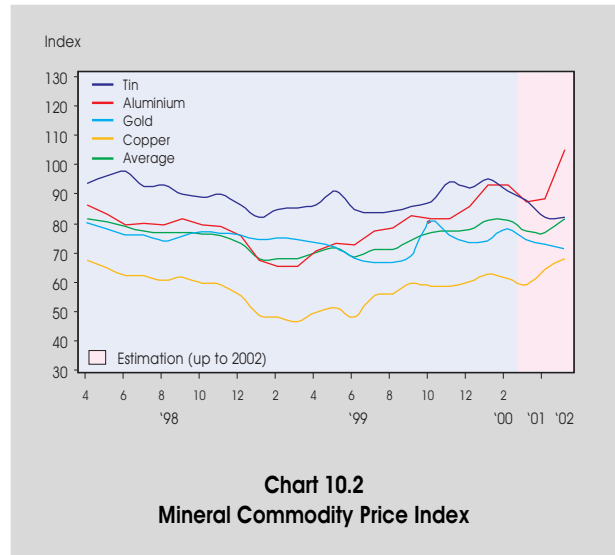

boost exports (Chart 10.2). Export prices for mining products are expected to rise due to growing demand, especially due to the rapid development of the People's Republic of China's manufacturing industry and the semiconductor industry in the US, as well as reduced supply of mineral products world wide. Prices for several major mineral exports, such as nickel and aluminium, are expected to decline because of the increasing use of recycled products. The prices of major agricultural export items such as rubber, coffee, tea and chocolate may rise slightly but no major price increases are expected, due to growing production and supply. (Chart 10.3).

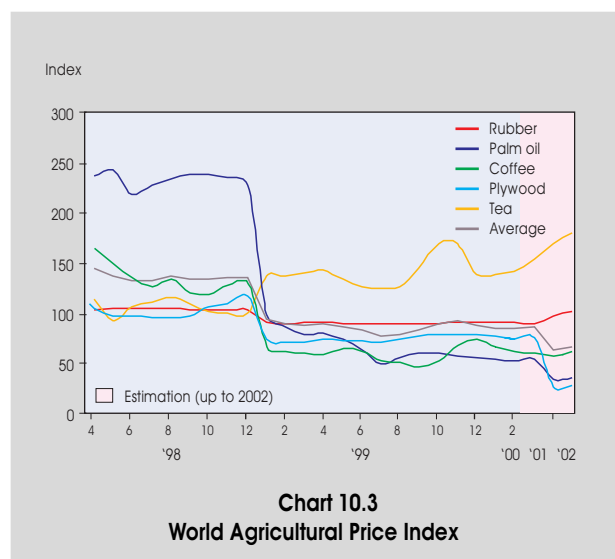
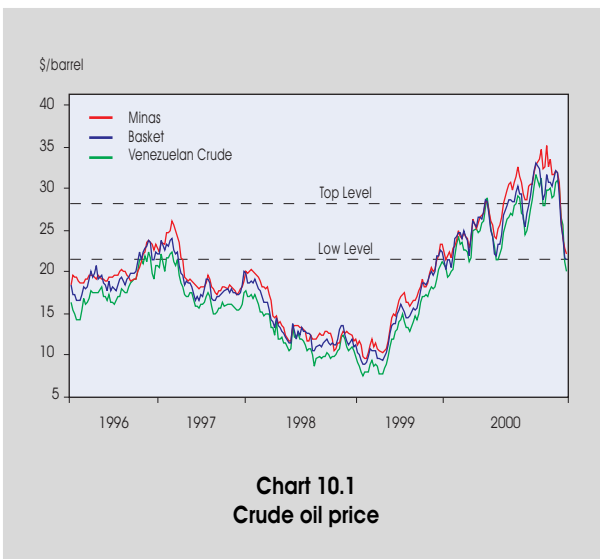

Prospects for the Indonesian Economy

Indonesia's economic prospects in 2001 are expected to continue to improve, as reflected in the Leading Economic Indicators (LEI), which is still quite high (Chart 10.4). After recording growth of almost 5.0% in 2000, economic growth in 2001 is expected to be between 4.5% and 5.5%. This moderate growth marks a continuation of the recovery process. On the demand side, export activities and investment are still the two main factors contributing to growth. On the supply side, growth is expected to come from manufacturing, trade and construction.

With economic recovery proceeding in almost all sectors, the output gap is narrowing. This will encourage firms to undertake new investment to meet rising demand. With an optimistic outlook for investment, growth of the Indonesian economy should remain strong over the next few years.

Demand

The main factors contributing to growth in 2001 are expected to be exports, investment and consumption, with growth from these three sources being more balanced in 2001 than in 2000. Although export growth expected to remain high, it will be lower than the previous year mainly because economic growth in Europe and the United States is expected to decline, reducing the growth of demand for Indonesian exports.

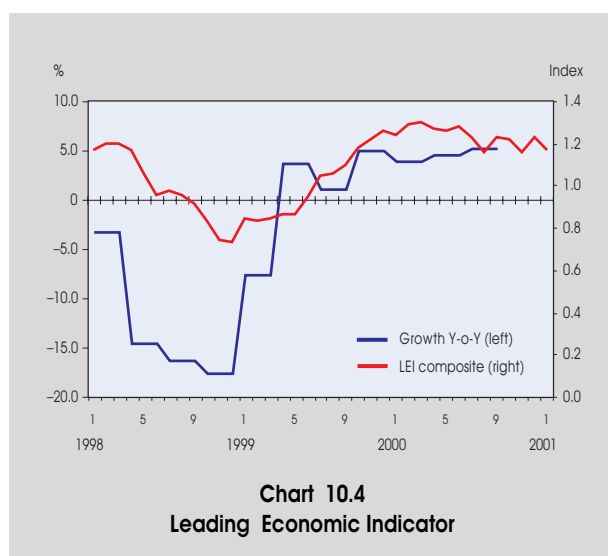

The export of manufactured products, such as plywood, garments, pulp and electronics, as well as mining commodities such as nickel, ore, aluminium and metal, are projected to provide a significant contribution to export growth. Exports of agricultural products are expected to provide a more limited contribution. With both investment and exports rising, imports are expected to increase, particularly imports of raw materials and capital goods. Exports of goods and services are expected to grow by 8.5%-10.5% and imports of goods and services are expected to grow by 11.0%-13.0% (Table 10.3)

Looking at the balance of payments, the current account surplus is expected to decrease to between 2.0% and 4.0% of GDP (Table 10.4). Capital outflows are expected to increase and foreign investment in Indonesia is projected to grow significantly. This reflects improving overseas confidence in Indonesia's on-going economic recovery. With the foreign debt burden decreasing, the capital account will record a smaller deficit.

Investment growth in 2001, especially private investment, is expected to be relatively high due to improving business prospects, the need to increase production capacity, especially in export-oriented industries, and improved availability of financing from banks. Bank Indonesia's fourth quarter 2000 survey of business activity indicated that business activity in the

Table 10.3
GDP Growth

Item	Tahun	
	2000**	2001 ¹⁾
Assumption		
World Trade Volume Growth (%)	11.5	9.2
Oil price (\$/barrel)	25	25
LIBOR 3 month (%)	6.5	6.5
Yen/\$	105	105
Rp/\$	8,400	8,000
Fiscal Deficit (% of GDP)	6.5	3.5
Projection (% annual growth)		
Real GDP	4.8	4.5-5.5
Consumption	3.9	3.0-5.0
Investment	17.9	10.0-12.0
Exports of goods and services	16.1	8.5-10.5
Imports of goods and services	18.2	11.0-13.0

1) Projection

Table 10.4
Indonesian Balance of Payments Prospect

Item	2000**	2001 ¹⁾
	In billions of \$	
Current account	7.7	4.7
Export (f.o.b)	62.5	65.2
Oil/gas export	15.5	13.7
Non-oil/gas export	47.0	51.5
Import (f.o.b)	-37.4	-41.4
Oil/gas import	-5.3	-4.6
Non-oil/gas import	-32.1	-36.7
Services (net)	-17.4	-19.0
Current account (% of GDP)	5.0	2.0 - 4.0
Capital Account	-4.6	-1.3
International reserve		
Nominal	29.3	32.7
In months of imports	6.3	6.1

1) Projection

first quarter of 2001 would continue to rise in all sectors, except the agriculture and mining sectors (Chart 10.5). Business activity is expected to continue to improve in 2001, in line with the improving trend in the business activity survey since the third quarter of 1999. Investment in the first quarter of 2001 is also expected to rise, as reflected in the upward trend over the past two years in the number of respondents that have undertaken investment (Chart 10.6).

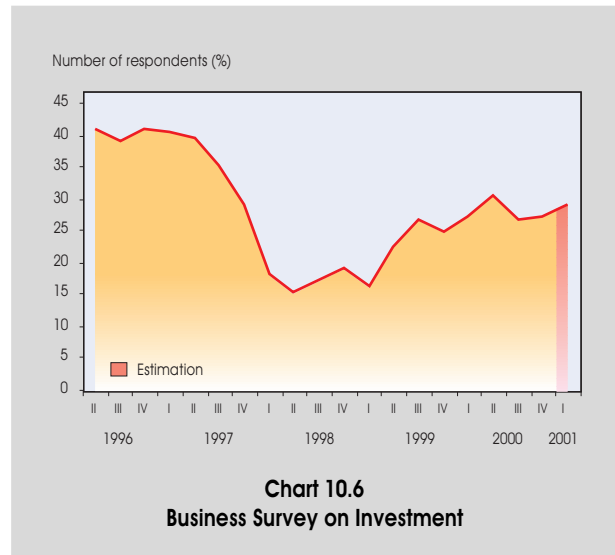
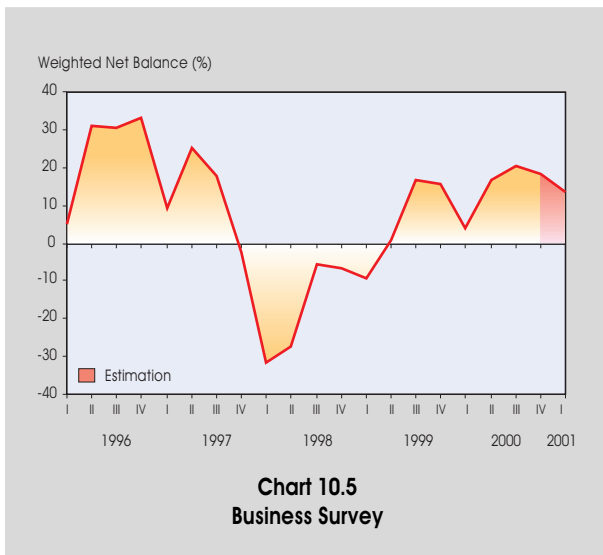

Investment approvals in July 2000 rose, especially for foreign investment approvals (Chart 10.7). Domestic and foreign investment realization also recorded an improvement through July 2000 (Chart 10.8). With an improved security situation and more stable domestic politics in 2001, both investment approvals and realizations are expected to continue to rise.

Financing for investment, which was the major constraint to increased productive capacity in 2000, is expected to come from self-financing, commercial paper and bank financing. Banks are expected to increase lending significantly in 2001

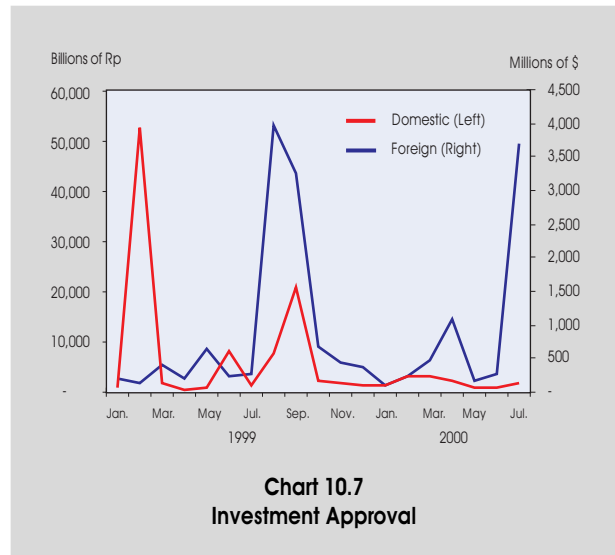

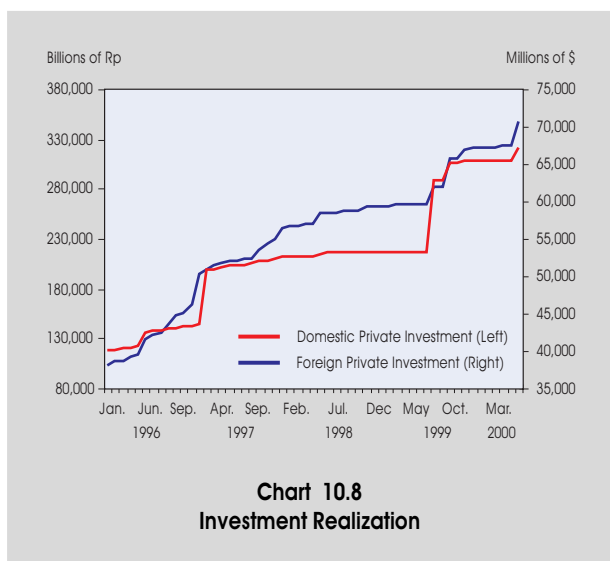

Chart 10.8
Investment Realization

following success in the credit restructuring and corporate debt settlement program under the Indonesian Bank Restructuring Agency (IBRA). As of the end of 2000, value of credit restructured by IBRA and ready to be sold to the banking sector stood at Rp80.9 trillion.

External sources of financing are also expected to improve in 2001 as a result of slow economic growth in Europe and the United States, which should encourage investors to move funds to emerging markets, opening up opportunities for capital inflows to Indonesia in line with improvements in non-economic factors. However, capital inflows are expected to remain relatively small, as investors are aware that the economic reform process in the region in the aftermath of the Asian economic crisis has proceeded slowly.

Investment, in the form of expansion or establishment of new factories, is expected to continue in export-oriented industries that have reached high levels of capacity utilization, such as the non-ferrous metal industry, the textile industry and the garment industry. Most investment in 2001 is expected to take the form of construction. However, investment in manufacturing as a whole is not expected to be strong because of continued excess capacity. In addition to large scale industry, investment is also expected in medium scale industry following the availability of funds for expansion. Supported by government investment in productive sectors and the repair-

ing of various social facilities and infrastructure, investment as a whole is expected to grow by 10.0% – 12.0% in 2001.

Consumption is expected to grow at roughly the same rate as in the previous year, in the range of 3% to 5%. With this growth rate, consumption will continue to play a significant role in GDP growth. The December 2000 consumer confidence survey indicated that in general the public’s financial condition for the coming six to twelve months is relatively safe (Chart 10.9). With households optimistic about their financial situation in 2001, consumption is expected to continue to increase. Nevertheless, the relatively low rate of consumption growth relative to overall GDP will reduce the contribution of consumption to GDP growth (Chart 10.10)

The main source of consumption growth is expected to be rising household income, following predictions of economic improvement in 2001. In addition, the government policy of increasing household purchasing power by raising civil servant salaries and regional minimum wages (UMR) is expected to provide a boost to consumption. Interest rates are expected to move within an appropriate range, which should reduce constraints from the financing side and provide an added stimulus to household consumption. Given these developments, household consumption is expected to grow by 2.0% – 4.0% in 2001. Government consumption is expected to grow rapidly as a result of higher budget allocation for routine expenditures

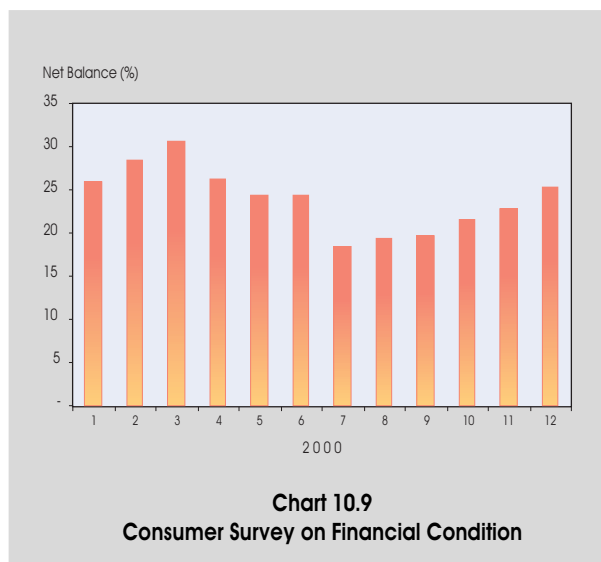
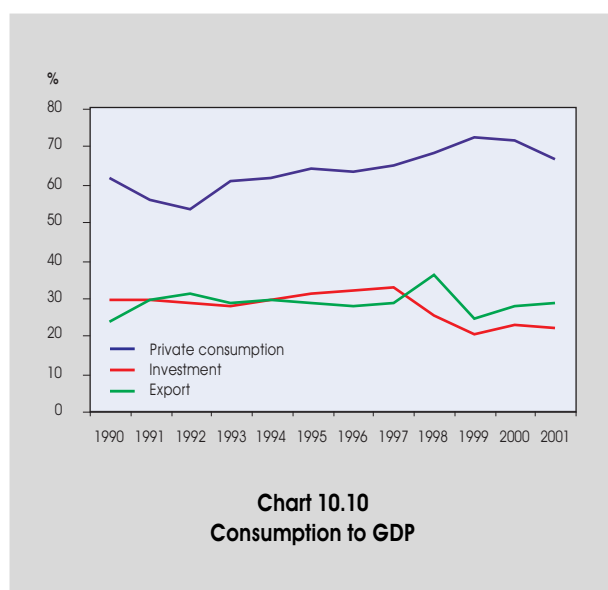

Chart 10.9
Consumer Survey on Financial Condition



in the 2001 draft state budget (RAPBN). The relatively large allocation for consumption activities in the draft state budget is also expected to provide a significant contribution to economic growth.

Supply

From supply side, all economic sectors are expected to record positive growth in 2001 with the manufacturing, trade and property sectors expected to contribute the most to growth (Table 10.5). Growing production in 2001 will be related to rising do-

Table 10.5
GDP Growth by Sector

Sector	Year (% y-o-y)	
	2000**	2001 ¹⁾
Agriculture	1.7	1.0-2.0
Mining	2.3	3.0-4.0
Manufacturing	6.2	5.5-6.5
Electricity	8.8	7.5-8.5
Construction	6.8	9.0-10.0
Trade	5.7	6.5-7.5
Transportation	9.4	6.5-7.5
Finance	4.7	5.5-6.5
Services	2.2	3.0-4.0
Total	4.8	4.5-5.5

1) Projection

mestic and external demand. Economic sectors that will benefit from domestic demand include the property and trade sectors. Growth in the mining sector will be mainly toward exports.

Agriculture in 2001 is expected to perform slightly better than in 2000 as a result of improved climate conditions. In addition, interest rate subsidies on agricultural credit programs are expected to stimulate agricultural output. The main contribution to higher growth in the agricultural sector is expected to come from the fishery and food crop subsectors.

Mining is expected to grow by 3.0%-4.0% in 2001. Productions of mining and mineral products are expected to increase slightly, mainly in response to demand for imports in industrialized countries. Rising prices for mining and mineral products in the international market will stimulate domestic mining activity. The rising trend for copper production in 2000 is expected to continue in line with rising copper prices. Domestic oil production is also expected to increase following agreement by OPEC countries to increase production in response to excessively high world oil prices.

Manufacturing is expected to grow by 5.5-6.5% in 2001. Several indicators point to higher manufacturing output, including cement production, vehicle production, and the availability of industrial space in the Jabotabek area (Jakarta, Bogor, Tangerang, Bekasi). Higher cement production is related to the recovery of residential property construction, as developers start to aggressively market new houses. Cement production in 2001 is expected to either increase slightly or to remain at the 2000 level in response to continued high demand for residential property. Similar trends are expected for automobile and motorcycle production. Motorcycle production is expected to continue to increase because of high demand, although recently the motorcycle sector was flooded with imports from People's Republic of China. Rising demand can be met from existing capacity, as production is still below pre-crisis levels. The productions of sedans and vans are also expected to increase with relatively strong domestic demand. High demand for vehicles is reflected in a rising trend for sales.

The electricity sector is expected to grow by 7.5%-8.5% in 2001. Electricity sales grew at an average annual rate of 11% during the period of January 1998 to November 2000 and this trend is expected to continue, with higher electricity consumption in industrial and household sectors. However, one potential obstacle to growth in the electricity sector is the output capacity of the state electricity company (PLN), which is suffering from a number of problems, including a very large foreign debt burden. Private electricity generation is also facing constraints, mainly as a result of problems in contracts with the government.

The construction sector is expected to experience growth of between 9.0% – 10.0% in 2001, marking a significant increase relative to 2000. Growth in this sector can be seen in a number of indicators, including rising cement consumption, residential-estate sales, and in plans to continue infrastructure projects that were delayed during the economic crisis. The significant increase in cement consumption seen during 2000 is expected to continue in 2001 in line with the recovery of the residential property sector and the increase in house loan activities (KPR). Increased house hold purchasing power and aggressive marketing of house loans (KPR) by banks caused demand for residential property to rise. The plan to resume development of infrastructure projects, including the Jakarta Outer Ring Road, the double track Jakarta-Surabaya railway, the Tanjung Perak port in Surabaya, and the trans-Sumatera railway project, will have a major impact on construction activity.

Trade is expected to grow by 6.5%-7.5% in 2001, up from 6.1% in 2000. One sign of rising activity in this sector is the 200% growth of vehicle sales in the first 11 months of 2000. Sales are expected to increase in line with rising demand and increased household purchasing power. The momentum of increased activity in the trade sector was reflected in the retail sales index in 2000, which was driven by clothing and equipment sales as well as by sales of vehicles and spare parts. This growth is expected to continue. The occupancy rate and supply of office space in Jakarta and the occupancy rate for hotels is expected to increase slightly in 2001 in line with firmer economic growth and improving domestic social, political and security conditions.

The transportation sector is expected to grow by 6.5%-7.5% in 2001 in line with growth of trade and manufacturing activity, as these activities require transportation services. Transportation growth is also expected to come from more mobile population in line with a more conducive business climate and economic situation in 2001. However, transportation growth is not expected to be as high in 2001 as it was in 2000, when the Idul Fitri holidays occurred two times in 2000.

The financial sector is expected to grow more rapidly in 2001 in accordance with improved profitability of banks, as reflected by higher net interest margins (NIM) and a drop in non-performing loans (NPL). The improved condition of the banking industry was caused by an increase in the credit portfolio of banks, as banks began to buy back loans that had been restructured by IBRA, along with an increase in new lending activity. As of the end of December 2000, credit that had been restructured by IBRA and was ready to be sold to banks in 2001 totaled Rp80.9 trillion. Moreover, banks have a great deal of excess liquidity in the form of SBIs and tradable government bonds that can be used to support new lending activity. The main recipients of bank credit in 2001 are expected to remain in the trade, hotel and restaurant, and manufacturing. Demand for credit is on an upward trend. In broad terms, the results of the bank survey in the fourth quarter of 2000 showed that in net 75.0% of respondents expect an increase in demand for new credit in the first quarter of 2001. Credit growth is due not only to an improved business climate but also to relatively moderate real interest rates.

The service sector is expected to grow by 3.0% – 4.0% in 2001, with growth supported by increased government services in line with the implementation of regional autonomy. The allocation of funds for regional governments will be focused on public services. Moreover, sales of electricity for public and social purposes are on a rising trend, with sales for public purposes up by 55.65% and sales for social purposes up by 11.76% in the period through November 2000 relative to the same period in 1999. Electricity sales to the public sector have been relatively stable while sales for social purposes, which had dropped sharply, have returned to the pre-crisis level.

Prospects for the Exchange Rate

Risk and uncertainty factors, mostly the domestic political and security situation, are expected to still affect the rupiah exchange rate in 2001, particularly during the first half of the year. In second half of 2001 the exchange rate is expected to strengthen in line with improvement of various factors, both domestic and international. With the expected strengthening of the rupiah in second half of the year, the average exchange rate in 2001 is expected to reach Rp7,750 – Rp8,250 per US dollar, up from an annual average of Rp8,400 per US dollar in 2000 (Chart 10.11). The projected average exchange rate will be attainable if there are no disturbances from domestic non-economic factors, allowing the risk premium to return to the best level, as in March 2000.

The development of the risk premium in 2001 is expected to still affect the direction of the exchange rate. In general, the risk premium in 2001 is expected to improve compared to that in the previous year. As in previous years, the risk premium is expected to increase prior to the annual meeting of the People's Consultative Assembly in August 2001. However, with a political and security situation that hopefully will improve, the connection between the risk premium and the exchange rate should gradually decline, so that the direction of the exchange rate will increasingly reflect Indonesia's improved economic fundamentals.

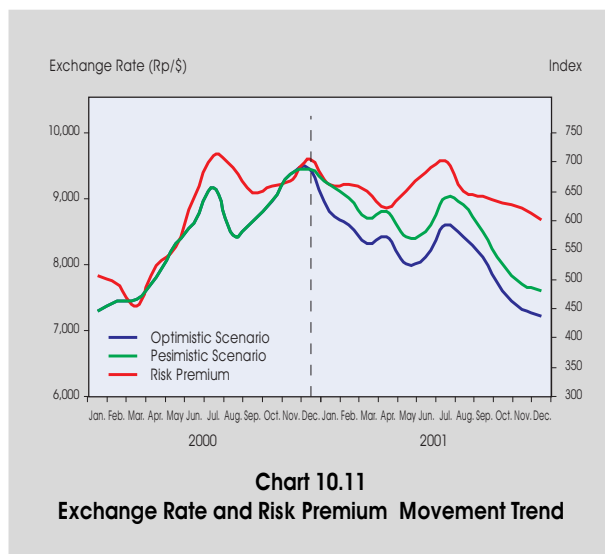

Chart 10.11

Exchange Rate and Risk Premium Movement Trend

From the domestic perspective, the improvement of Indonesia's economic fundamentals in 2001 is expected to help restore market confidence in the rupiah. Moreover, as confidence in the national economy grows, capital inflows from international trade transactions and capital transactions are expected to increase. This is in line with the progress of private debt restructuring, which is expected to reduce the foreign currency demand of companies and to increase the foreign currency supply originating from exports and capital inflows to Indonesia. As a result, the gap between the demand and supply of foreign currency is expected to become increasingly smaller.

It is hoped that the domestic political and security situation will become increasingly stable after the annual session of the People's Consultative Assembly in August 2001. However, caution is warranted in light of the fact that market confidence in the national economy could decline giving rise to speculative demand for foreign currency or demand for assets as non-economic tensions escalate. This could put additional pressure on the rupiah.

Externally, slower growth in the United States in 2001 is expected to lead to lower interest rates, which should prevent appreciation of the U.S. dollar globally. Capital flows to emerging markets in Asia including Indonesia will start to increase although international investors will remain concerned about the high risk level in emerging markets.

Prospects for the Inflation

Inflationary pressure is expected to remain high in 2001, which should be watched closely. In general inflationary pressure will come from both fundamental and non-fundamental factors. The fundamental factors are resulted by the interaction among economic factors, including (1) expected inflation, (2) more rapid growth of household demand reflected in the output gap, and (3) the pass through effect from the exchange rate both to changes in world prices and to changes in the rupiah exchange rate. Non-fundamental factors relate mainly to government policies and natural disasters as well as distribution problems.

Looking at fundamental factors, strong pressure will come from expectations and demand. Demand pressure is expected to come from relatively strong government consumption, strong investment and export activities, which reduce the output gap. Moreover, accelerated growth of output, which is already near capacity, will create stronger inflationary pressure. The narrowing of the output gap is in line with the leading indicator of inflation (LII) which showed an upward trend until 2001 (Chart 10.12). The rise of the LII is expected to continue in 2001.

The results of the December 2000 consumer confidence survey indicated that over the next six to twelve months prices were expected to rise (Chart 10.13). Higher prices were expected mainly for housing and building materials, food, transportation and communication.

Inflationary pressure from external sources is not expected to be significant. Slower world economic growth is expected to keep world inflation low. The rupiah exchange rate is expected to strengthen as the economy continues to recover and the domestic political and security situation improves. The strengthening of the exchange rate will have a deflationary impact on the price level. However, because prices tend not to be flexible in a downward direction, the deflationary impact of a stronger exchange rate is expected to be relatively small.

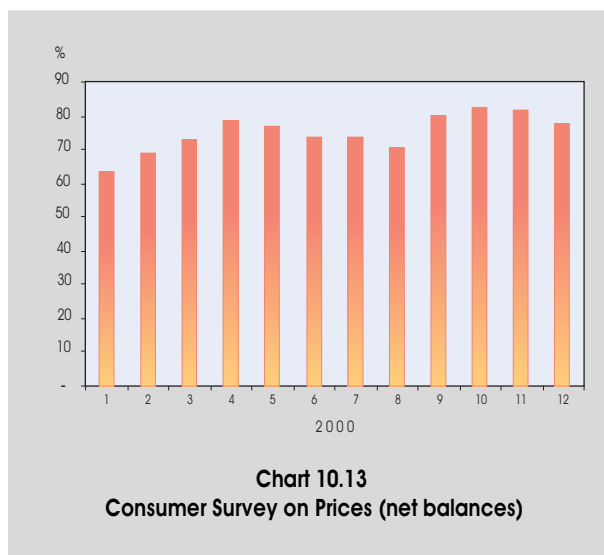
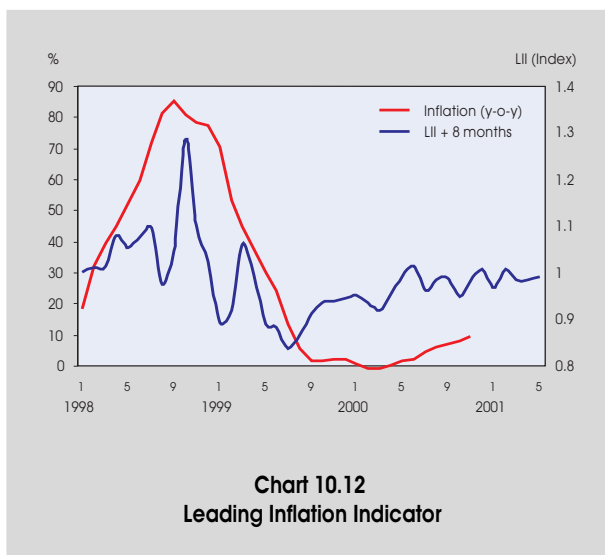

Caution is required with respect to the exchange rate in 2001 because exchange rate movements can be strongly influenced by domestic risk factors and uncertainty. Prices are highly sensitive to depreciation of the exchange rate, particularly prices for traded goods. The weight of traded goods in the consumer price index is very high, at around 60%, and price changes for traded goods can therefore have a strong impact on the inflation rate.

Non-fundamental factors contributing to strong inflationary pressure are resulted from the government's price and incomes policies. These policies will continue in 2001 and subsequent years in line with government plans to reduce subsidies in the state budget (APBN). In 2001, government price and incomes policies that have been identified include higher fuel prices (BBM), an increase in the floor price for unhulled rice, an increase in the cigarette excises, higher civil servant salaries with a change in the salary structure, and an increase in regional minimum wages. An increase in electricity rates is currently under consideration but the government has not yet made any plan to reduce electricity subsidies in the 2001 state budget (APBN). Overall, government price and incomes policies so far identified are expected to increase inflation in 2001 by around 2.5% (Table 10.6).

The plan to implement regional autonomy in 2001 is expected to have the potential to create inflation in particular

Table 10.6
The Impact of Government Policy to the Inflation in 2001¹⁾

Government Policy	Impact Coefficient	Price/tariff increase	Inflation Impact	Effective
Price Policies :			2.09	
Electricity Tariff	0.013	-	-	
Fuel	0.075	20	1.49	April
Rice	0.024	-	-	
Unhulled rice	0.045	7	0.32	January
Cement Price	0.028	-	-	
Cigarette excise tax	0.037	5	0.18	August
Water price	0.005	20	0.10	January
Income Policies :			0.37	
Civil servant salary	-	30	0.20	
Minimum wage	0.012	15	0.17	whole year
Other :				
Regional autonomy	-	-	-	whole year
Total			2.47	
1) Projection				

areas. From the demand side, this is reflected in regional expenditures, which tend to be expansive. On supply side price pressure is expected from an increase in regional levies, retribution, and regional taxes, and from other efforts to raise revenue within each region. However, it is still difficult to estimate the impact on inflation from the implementation of regional autonomy in 2001.

Other non-fundamental factors are expected to come from the prices volatility, particularly food prices. Changes in food prices have a large impact on inflation due to the high weight of food in the consumer price index market basket. Historically, food price volatility tends to have an inflationary impact. However, 1999 and 2000 were exceptions in that food price volatility had a deflationary impact in 1999 and contributed to low inflation in 2000. This was the result of an excess supply of food and a price correction in 1999 following an extremely sharp increase in food prices in 1998. In 2001, the volatility of food prices is expected to return to normal, with an upward price tendency.

The indication that inflationary pressure will remain strong in 2001 is in line with forecasts from various economic research institutions. The average inflation rate in 2001 projected by national research institutes is 7.9%. The average in-

flation rate projected by international research institutions is more optimistic, at 7.1%.

The Inflation Target

Considering the relatively high inflation projections from the above institutions as well as significant sources of inflationary pressures in 2001, it is Bank Indonesia's opinion that inflationary pressure must be contained. Looking at macroeconomic developments and prospects and considering price developments that can be influenced by monetary policy, Bank Indonesia has set an inflation target for 2001 of 4.0%–6.0%, excluding the impact of the government's price and incomes policy. The government's price and incomes policy is expected to contribute an additional 2.0%–2.5% to the annual inflation rate over and above the inflation target.

During the course of the year, various events that are beyond the control of monetary policy can take place, including supply shocks and exchange rate fluctuations caused by non-fundamental factors. A monetary response to such shocks could be costly since it would require an excessive monetary tightening which could slow the economic recovery process. Consequently, a number of exceptions must be put forth, in the form of conditions under which the inflation target can be exceeded, including:

- the existence of inflationary policies from the government, including both the central government and regional governments, that have not yet been identified or included in inflation projections,
- exchange rate fluctuation that is not connected with economic fundamentals or with domestic monetary policy,
- security disturbances and natural disasters that can cause drastic changes in production and distribution of food with an impact on the price of basic foodstuffs.

Future Challenges

Indonesia's macroeconomic prospects in 2001, including the outlook for inflation and the rupiah exchange rate, will be greatly influenced by the development of various risk factors and uncertainties that still shadow the national economy. There-

fore, efforts to address these factors will be the key for success in guaranteeing a stronger economic recovery in 2001 and in coming years. These risks and uncertainty factors include:

- **First**, the possibility of continuing uncertainty regarding the domestic political and security situation. Continued uncertainty will keep Indonesia's country risk high, cause the handling of economic problems to be slow and uncertain, and will encourage speculation in the foreign exchange market.
- **Second**, failure to complete the restructuring of corporate debt. This has already delayed the recovery of economic activity and bank lending, because most of the companies that are still in the process of restructuring constitute the biggest share of the national economy.
- **Third**, the bank intermediation function has not returned to normal. Credit expansion from the banking system is still limited because of continued high levels of risk and uncertainty, the large number of companies still in the process of restructuring, and the internal condition of banks. This greatly limits the sources of financing for economic activity, with the result that most economic activity is self-financed. Moreover, the incentive for banks to mobilize funds is relatively low, causing the interest rate on bank deposits to be low and encouraging the public to use their funds for consumption or other forms of investment.
- **Fourth**, the government's financial burden is still heavy, mainly due to the high cost of subsidies and interest payments on domestic debt. The financial burden is expected to be covered by IBRA asset recoveries and proceeds from privatization of state companies. At the same time there are demands that the government reduces foreign borrowing to maintain medium and long term fiscal sustainability. In light of this situation, fiscal stimulus to accelerate economic recovery will be limited over the near term.
- **Fifth**, the smooth implementation of regional autonomy in 2001 will be a key factor in the success of the economic recovery process and the equitable distribution of economic development in the future. Threats to economic

recovery and price stability will appear if regional expenditures are not well coordinated and if regional governments scurry to increase regional levies, retribution and regional taxes.

- **Sixth**, there is a high level of legal uncertainty in Indonesia. Various cases demand reformation of the legal sector and law enforcement, mainly through the implementation of bankruptcy law and thorough reform of the judicial system.
- **Seventh**, there are external risks, with the main risk being a potential economic downturn in the United States. Slower US economic growth would be a threat to optimistic forecasts for exports, which are expected to be a major source of economic growth for Indonesia in 2001.

Policy Directions

With due concern to the inflation target of 4.0% – 6.0% and in order to continue efforts to stabilize the rupiah exchange rate, Bank Indonesia will adopt a tight bias monetary policy in 2001. In implementing this policy, monetary policy will be undertaken with great care in light of the fact that the intermediation function of the banking system has not yet returned to normal and given the fragility of the economic recovery process. Through the middle of 2001, both inflation and the exchange rate are expected to come under a good deal of pressure and consequently the tight bias monetary policy must be maintained for the time being. If pressure on inflation and on the exchange rate diminishes, a relaxation of monetary policy will be possible. Given this policy direction, Bank Indonesia needs to establish monetary targets, particularly for base money, which is targeted to grow at 11.0%–12.0% in 2001. The base money target is calculated on the assumption that economic growth reaches 5.0%, inflation is between 4.0%–6.0%, and the average annual exchange rate comes to Rp8,000 per U.S. dollar. The base money target of 11.0%–12.0% is expected to be consistent with the achievement of the inflation target without creating excessive risk for the recovery of the national banking system and the overall economy. The base money target will need to be adjusted if economic growth or the movement of

the rupiah exchange rate are not in line with the above assumptions, or if there are inflationary developments caused more by factors beyond the control of Bank Indonesia, as explained above. With this growth rate for base money, the broad money supply (M2) is expected to grow by around 9.0%-11.0% and credit is expected to grow by around 14.0%-16.0% to support the process of economic recovery.

In the operation of monetary policy, efforts to achieve monetary targets are carried out through Open Market Operations (OPT) with auctions of SBIs as the main instrument. However, optimum utilization of other monetary instruments needs to be executed properly. To maintain a conducive climate for recovery of the banking system and the economy, steps are also needed to ensure that the implementation of monetary policy does not cause an excessive rise in interest rates.

In principle the strategy for monetary management in support of open market operations should include the following measures:

- **First**, open market operations using rupiah interventions should be optimized for the time being to support attainment of the established base money target without an excessive increase in SBI interest rates. This is also aimed at improving the structure of interest rates, with the relationship between the SBI rate, the rupiah intervention rate, and inter bank interest rates managed in a way that is conducive for the implementation of monetary policy.
- **Second**, foreign exchange sterilization will remain an open option, particularly to absorb the expansionary impact of government expenditure financed from foreign sources. This can reduce the burden on open market operations in attaining monetary targets so that an excessive increase in SBI interest rates can be avoided. This effort is also aimed at strengthening the rupiah exchange rate to a level in accordance with the fundamental condition of the economy.
- **Third**, government bonds, which are expected to begin actively traded in the secondary market, can be used as an alternative monetary instrument — with the main

objective to reduce cost of open market operations arising from the use of SBIs. With a sufficiently high yield on staple bonds, and on short-term government bonds that are to be issued, it is expected to be advantageous for Bank Indonesia to maintain a portfolio of these two types of bonds as a monetary instrument (Box: Government Bonds as an Alternative Monetary Policy Instrument).

The strategy for monetary management needs to be supported by an exchange rate policy based on a floating and free exchange rate system. However, it should be realized that the monetary management strategy will be less effective at controlling inflationary pressure and rupiah fluctuations caused by external factors beyond Bank Indonesia's control. Therefore, options must remain open to use various measures that can directly reduce exchange rate fluctuations. Efforts to maintain the stability of the exchange rate can be undertaken through selective sterilization activity in the foreign exchange market as an instrument of monetary control. As mentioned above, this policy is mainly aimed at absorbing monetary expansion caused by increased government expenditure financed from foreign sources. Aside from conventional instruments such as intervention in the foreign exchange market, various non-conventional alternatives need to be undertaken, such as direct supervision of banks suspected of speculating in foreign currency and the improvement of regulations governing foreign exchange flows, including limits on the internationalization of the rupiah.

Implementation of monetary policy needs optimum support from banks so that the transmission of monetary policy to the real sector can operate effectively. One main challenge for monetary policy and for banks in 2001 is how to address the credit crunch problem. Various measures need to be undertaken by Bank Indonesia to immediately restore the bank intermediation function. On the macro side, it is Bank Indonesia's view that monetary policy to create conducive climate for the process of bank and corporate restructuring is required, as reflected in interest rate and exchange rate stability. On the micro side, since the credit crunch is mainly caused by non-price rationing, such as the continued high level of credit risk faced

by banks and lack of information on creditworthy potential borrowers, various efforts will be undertaken by Bank Indonesia in cooperation with other related institutions. Bank Indonesia will amend various regulations to reduce the obstacles faced by banks in extending new loans and will increase regulations to increase the resilience of the banking industry in the face of macroeconomic changes. Credit restructuring to reduce the level of non-performing loans will remain a priority. With the restoration of the bank intermediation function, it is expected that the effectiveness of monetary policy in influencing the real sector will improve.

Various efforts to increase supervision and improve regulations in accordance with international standards will continue to be carried out by Bank Indonesia. Bank Indonesia will also encourage banks to improve their risk management by issuing risk management guidelines, which later will be followed up with implementation of risk based supervision. Looking forward, supervision undertaken by Bank Indonesia will utilize an approach that focuses on systemically important banks. In relation to the separation of bank supervision to a new supervision body (a Financial Service Supervision Institution), Bank Indonesia continues to undertake preparations so that the hand over of supervision can run smoothly and will not disturb the banking system. In addition, preparations are also being undertaken so that the flow of banking data and information needed for formulating monetary policy does not face obstacles.

As part of the effort to create a healthy banking sector in accordance with international standards, banks are required to meet a capital adequacy ratio of 8.0% and a non-performing loan ratio of 5.0% or less by the end of 2001. Policies to meet the 8.0% capital adequacy ratio include requiring shareholders to inject additional capital, merging banks, seeking new investors both domestically and internationally, and implementing an exit policy. To meet the 5.0% non-performing loan (NPL) ceiling, policies include: 1) requiring banks to write off non-performing loans after a certain period of time, and 2) addressing obstacles that hamper restructuring efforts undertaken by banks and those facilitated by the Credit Restructuring Task Force and the Jakarta Initiative Task Force.

The development of syariah banks in 2001 will be focused on opening up front offices to serve sharia banks in the branch offices of conventional banks. This will only be provided to conventional banks that want to convert their branch office into a syariah bank branch. The expansion of the syariah bank network will be guided by the result of a survey on prospects, preferences, and bank's attitude toward syariah banking.

To support the effectiveness of monetary policy, Bank Indonesia will continue to enhance the smooth functioning of the national payment system. As a follow up to the first stage of the Real Time Gross Settlement (RTGS) system, which was implemented in November 2000, a system for settling large bulk transactions will be applied in twelve Bank Indonesia regional offices. Integrating the RTGS system between head and regional offices of Bank Indonesia will allow the demand deposits of commercial banks in Bank Indonesia regional offices to be abolished as there will be only one demand deposits in Bank Indonesia's head office (centralized settlement account). The consolidation of this account will benefit both Bank Indonesia and the participating banks as it will be easier for Bank Indonesia to monitor the compliance of banks with the statutory minimum reserve requirement (GWM). Moreover, Bank Indonesia will be able to better monitor the liquidity position of banks and this information can be used as an early warning system for banks that suffer liquidity problems. For the participating banks, the consolidation of the accounts will make it easier for them to monitor their liquidity position, allowing banks to manage their funds more effectively and efficiently. In addition, the first stage of the Delivery Versus Payment (DVP) system will be developed to reduce settlement risk in security companies. This will support the development of an integrated settlement system between the money market and the capital market.

To increase the efficiency of banks and to accelerate the clearing process, Bank Indonesia will implement a Bulk Interbank Payment System (BIPS) in 2001, which is a special clearing system for bulk transactions that will accelerate the speed with which interbank transactions are cleared. Bulk

transactions are routine inter bank transactions with high volume and low nominal value such as payment of salaries and wages, credit cards, insurance, credit installments, utility bills, and so on.

In order to ensure the efficiency of bookkeeping and switching in banks operating ATMs in Indonesia, as well as offering new facilities and security for their users, Bank Indonesia will facilitate and encourage banks that operate ATMs to connect their networks with each other.

The effectiveness of monetary policy depends greatly on coordination with fiscal policy. The magnitude of government expenditures needs coordination regarding timing and the implementation mechanism so that the implications for monetary policy can be anticipated and steps can be taken to maintain economic liquidity. Therefore, looking forward, coordination of monetary and fiscal policy can be increased and undertaken routinely.

In relation to foreign debt policy, it is expected that foreign borrowing will still be needed over the next few years since domestic investment requirements are still very high, particularly in the private sector, while domestic funding sources are very limited in line with the ongoing economic recovery process. With regard to government foreign debt, with the completion of preparations for the Act on government for-

ign debt, it is hoped that the policy and management of foreign debt in the future will only go through one gate, therefore there will be a clear role for each government department, making the mechanism and procedure for managing foreign debt more transparent. Commercial foreign debt is expected to continue to face a problem with international confidence due to the domestic economic and political situation, making it difficult to obtain loans through the money and capital markets. Therefore, in the future there will be a need for efforts to make a breakthrough with new instruments in the capital and money markets. To stimulate exports, a Trade Maintenance Facility (TMF) policy will still be needed because the confidence of international banks in domestic banks has not yet recovered.

As a closing note, Bank Indonesia's policy framework for creating price and exchange rate stability is basically one component of the overall macroeconomic policy framework. Measures in other areas, in particular to address various risks and uncertainty as explained above, are crucial for ensuring acceleration of the national economic recovery process. Therefore, Bank Indonesia needs to strengthen cooperation with related institutions to overcome problems that might arise and to realize the common aim of promoting the recovery of the Indonesian economy.

Box : Research on the Medium Term Inflation Target

At the beginning of each year, Bank Indonesia announces an inflation target covering a particular period of time. Establishing the inflation target is one part of the overall monetary framework policy in which price stability is the sole objective. This policy framework is characterized by an operational management of monetary policy that is forward looking, meaning that monetary policy is not implemented in response to past inflation but rather in response to anticipated future inflation so as to meet the established target. For this reason, monetary policy is implemented after calculating potential inflationary influences in the future.

The implementation of a forward looking monetary policy faces certain limitations, including the difficulty of estimating potential disturbances that could cause future inflationary pressure, given the existence of a high level of uncertainty. Monetary policy also faces limitations in controlling inflationary pressures caused by government price policy, which will continue to be quite significant over the next three years. Attaining a low inflation target is therefore unlikely in the short-term.

In addition, monetary policy is believed not to have an immediate impact on economic activities. There is a lag between implementation of monetary policy and its full effect on real economic activity. The lag is influenced by the channel through which monetary policy is transmitted to real economic activity. The monetary policy transmission mechanism is difficult to know with certainty, particularly given the continued existence of various structural obstacles in the economy, such as problems affecting the intermediation role of the banking system. The length of the monetary policy lag also varies depending on whether monetary policy is being tightened or loosened. The lag between Bank Indonesia's monetary policy and inflation is therefore difficult to predict. Research undertaken by Bank Indonesia has shown that monetary policy has a delayed effect on the real sector and on the inflation rate.

This limitation of monetary policy implies that a period of more than one year is needed to provide room for monetary policy to affect the economy. Consequently, in addition to establishing a short-term target, in the future Bank Indone-

sia should also establish a medium-term target, to be reached in stages, to demonstrate Bank Indonesia's commitment to reach and maintain a low inflation rate. The medium-term inflation target is expected to become a reference for public expectations regarding inflation.

Aside from the monetary policy lag, the amount of time needed to reach the target depends on how low the final inflation target is and on how much output policy makers are willing to sacrifice to reach the target. The criteria for choosing the inflation target and the optimum time period for attaining the target are based on minimizing the total fluctuation in inflation and in output that will take place over the period during which the inflation target is achieved. The total fluctuation in inflation and output, characterized by a trade off, is known as the total social loss.

The combination of the target level and the optimum time horizon to reach the target can be calculated through a simulation using a small-scale macroeconomic model equipped with a monetary policy rule in response to expected inflation. The graph of the optimal path and inflation shows the total social costs for various alternatives and time periods. Total social loss is minimized with an inflation target of 5%-6% within three years. It is estimated that a sufficiently low social loss would also occur by attaining an inflation target of 4.5%-5.5% within four years or 4%-4.5% within five years.

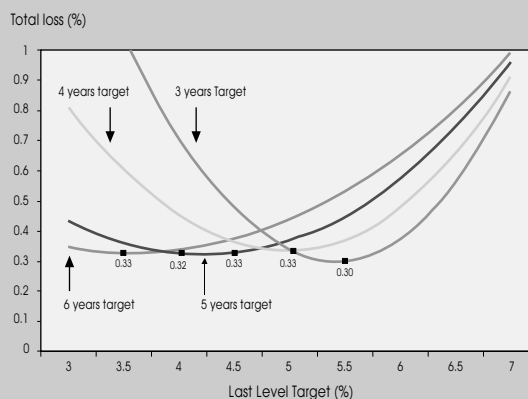

Optimal Path of Inflation

Referring to these research results, a medium term target for CPI inflation is 4%-6%, which is expected to be reached over the next five years. It is expected that this relatively low medium term inflation rate can be reached over the specified time period mainly because price increases caused by government policy are expected to diminish significantly begin-

ning in 2004. This is supported by price pressure from the demand side which is expected to be under control, in line with an improving investment climate so that production capacity continues to increase and the exchange rate becomes more stable. This disinflation process is not expected to have a negative impact on economic growth in the short term.

Box : Government Bonds as an Alternative Monetary Policy Instrument

In implementing monetary policy, the primary open market instruments employed in Indonesia are SBIs and rupiah interventions. SBIs are employed as a monetary instrument because government debt instruments suitable for this purpose do not exist. Bank Indonesia needs an instrument to carry out a monetary contraction to absorb excess liquidity which rose sharply during the crisis. As a consequence of the utilization of SBIs, Bank Indonesia must shoulder high interest costs on SBIs. This cost can cause problems in the continued implementation of monetary policy. Therefore there is a need for an alternative instrument. Bonds that have been issued by the government, both in the framework of the bank recapitalization program and in the framework of improving bank soundness for Bank Indonesia, could become an instrument of monetary policy, provided that the secondary market for government bonds is liquid.

The majority of central banks throughout the world utilize government debt instruments for open market operations. Using government bonds has benefits and weakness. The benefits of government bonds include: (i) they are issued in large quantities with varying maturities, (ii) they provide an opportunity to stimulate development of the money market, (iii) they provide a yield curve that can be used as a reference for the medium-to-long term and expectations of inflation, and (iv) from the central bank's point of view they reduce the cost of open market operations which has a positive impact on the credibility and effectiveness of monetary policy. On the other hand, the utilization of government bonds has certain weaknesses, including: (i) dependence on government credibility, which requires that the government maintain its credibility and fiscal sustainability, (ii) the central bank will depend on a sustainable supply of government bonds which requires a government commitment, (iii) there will be less distance between monetary management and fiscal management and (iv) gov-

ernment bonds can not be used as a benchmark for short-term interest rates.

The use of government bonds as an alternative open market instrument requires that Bank Indonesia own an initial supply of such bonds. The central bank can obtain a supply of government bonds from several sources, including :1) the purchase of variable rate bonds (VRB), recap bonds or fixed rate bonds (FRB) in the secondary market, 2) the conversion of interest payments on government bonds that are already owned by Bank Indonesia into marketable bonds (indexed bonds and VRB bonds credit program), 3) the conversion of principle on indexed bonds, in the framework of the guarantee program.

However, at the moment Bank Indonesia faces obstacles in obtaining an appropriate supply of bonds. Bank Indonesia's tight bias monetary policy stance means that Bank Indonesia cannot, on net, purchase government bonds in the secondary market, since any such purchase would cause a monetary expansion. Other obstacles include the fact that Bank Indonesia's current stock of indexed government bonds cannot be transferred or traded. The payment terms for these indexed bonds is also an obstacle. To resolve this obstacle, there is a need for an agreement between Bank Indonesia and the government to change the terms and conditions of indexed bonds and guarantee program bonds owned by Bank Indonesia, since any changes will have implications for the state budget.

By resolving the impediments to an increase in Bank Indonesia's holding of government bonds, and by developing a strategy for open market operations that makes use of government bonds as an instrument for fine tuning, both in the repo¹⁾ (Repurchase Agreement) market and in outright²⁾ transactions through auctions, it is hoped that in the future government bonds can become a monetary policy instrument.

1) Repurchase Agreements are purchases or sales that stipulate conditions under which an asset will be sold back or purchased back.

2) Outright are unrestricted purchases or sales with no conditions regarding re-sale or re-purchase.

Appendices





BANK INDONESIA

Head Office

Jakarta

Representative Offices

London
New York
Singapore
Tokyo

Regional Offices

Ambon, Balikpapan,
Banda Aceh, Bandar Lampung,
Bandung, Banjarmasin, Batam, Bengkulu, Cirebon,
Denpasar, Jambi, Jayapura, Jember, Kediri, Kendari,
Kupang, Lhoksemawe, Makassar, Malang, Manado, Mataram,
Medan, Padang, Palangkaraya, Palembang, Palu, Pekanbaru,
Pontianak, Purwokerto, Samarinda, Semarang,
Sibolga, Solo, Surabaya, Tasikmalaya,
Ternate, Yogyakarta

Appendix B

Board of Governors of Bank Indonesia

as of December 31, 2000

Governor

Syahril Sabirin

Senior Deputy Governor

Anwar Nasution

Deputy Governors

Miranda S. Goeltom

Aulia Pohan

Achwan

Achjar Iijas

Burhanuddin Abdullah

Appendix C.1

Organization and Human Resources

During the reporting year, Bank Indonesia made several improvements in its organization and human resources development. The improvement in organization covered several working units in line with the changes such as in technology, and workload. To improve the quality and quantity of Bank Indonesia research work in monetary, banking and payment system, a Center of Education and Central Bank Studies (PPSK) had been established.

In addition, to further improve the national payment system, a working committee responsible for the implementation of the Real Time Gross Settlement (RTGS) system was formed on May 2000. The system will help improve banking service to its customers particularly for large value non-cash transaction payment.

In line with the plan to transfer the authority over banking supervision from Bank Indonesia to a new independent body as stipulated by Act Number of 23 year 1999 article 34 on Bank Indonesia, a draft on human resources development in the banking sector had been prepared.

To anticipate the trend in domestic banking from conventional bank to Sharia bank, a concept of a more focused Sharia bank had also been set up.

In line with the new regional autonomy policy, seminars and discussions had been made with stakeholders of banks to see the implication of the policy to the banking sector and Bank Indonesia regional offices.

To improve the quality of the work of Bank Indonesia Board of Governors, an expert team which would provide inputs on strategic issues had been set up. Code of Ethics of Board of Governors of Bank Indonesia had also been completed.

Considering stakeholder demand that Bank Indonesia human resources must be more professional and have high integrity, the Management of Human Resources System (MSDM) program had been continued. The most urgent MSDM system that had reached finalization as a legal product is the disciplinary and career path management of Bank Indonesia employees.

The career path management is intended to provide direction for the organization in planning for Bank Indonesia human resources and to give description to the employees about their future career. The career path management is also expected to promote the principle of man to job fit.

To prepare candidates for future Bank Indonesia top officials, a Bank Indonesia Succession System (RESBI) had been set up. The system will provide clear pattern for Bank Indonesia in selecting its leaders that would fulfill the hope of all stakeholders.

In the field of Human Resources Information System (SIMASDAM), an improvement in relation to data and information accuracy had been made in order to deliver accurate, complete, up-to-date data for of the Board of Governors.

Number of Personnel

No,	Year	Head Office	Regional Offices	Representative Offices	Total
1,	1997/1998	3,341	2,882	67 ¹⁾	6,290
2,	1998/1999	3,299	2,852	21	6,172
3,	1999/2000	3,068	2,601	17	5,686
4,	2000 ²⁾	3,056	2,498	17	5,571

1) Including those studying abroad

2) Data on December 31, 2000

Head office

Directorate of Economic Research and Monetary Policy	:	Hartadi A. Sarwono
Directorate of Economic and Monetary Statistics	:	Ratnawati Priyono
Directorate of Monetary Management	:	Tarmiden Sitorus (ad interim)
Directorate of Reserve Management	:	Made Sukada
Directorate of International Affairs	:	Nana Supriana
Bureau of Credit	:	Abdul Azis
Directorate of Banking Research and Development	:	Djoko Sarwono
Directorate of Bank Licensing and Banking Information	:	Imam Sukarno
Directorate of Bank Supervision 1	:	Siti Ch. Fadjriah S.
Directorate of Bank Examination 1	:	Nelson Tobing (ad interim)
Directorate of Bank Supervision 2	:	R. Maulana Ibrahim
Directorate of Bank Examination 2	:	Ardhayadi M.
Directorate of Rural Bank Supervision	:	Abdul Salam
Directorate of Currency Circulation	:	Adi Putra Hasan
Directorate of Accounting and Payment System	:	Harmain Salim (ad interim)
Directorate of Logistic and Security	:	M. Ashadhi
Directorate of Information Technology	:	Octo R. Nasution
Directorate of Human Resources	:	Baridjussalam Hadi
Directorate of Financial Management	:	Bun Bunan E.J. Hutapea
Directorate of Legal Affairs	:	R. Moh. Sis. Abadi S.
Directorate of Internal Audit	:	Bachri Ansjori
Office of the Governor	:	Halim Alamsyah S.
Office of Secretariate	:	Roswita Roza
Special Unit For Banking Investigation	:	Bambang Setijoprodjo
Centre of Education and Central Banking Studies	:	Bambang S. Wahyudi

Representative Offices

Singapore	:	Kemas A. Sjarifuddin
Tokyo	:	Djakaria
London	:	Maman H. Somantri
New York	:	Aslim Tajuddin

Regional Offices

Category I

Bandung	:	Maskan Iskandar
Medan	:	S. Budi Rochadi
Semarang	:	Azis Sanuri
Surabaya	:	Wiwiek Sudibyo

Category II

Bandar Lampung	:	Imrandani
Banjarmasin	:	Suryanto
Denpasar	:	Ilham Ikhsan
Manado	:	M. Djaelani S.
Padang	:	Aris Anwari
Palembang	:	Langka Ardimumdinar
Makassar	:	Tjarlis Gafar
Yogyakarta	:	Hirawati Suherman

Category III

Ambon	:	M. Yusuf Oesep W.
Banda Aceh	:	Yusmanazir Katin
Cirebon	:	Djatiwalujo
Jambi	:	Ade N. Rachmana
Jayapura	:	Norman John
Malang	:	M. Zaeni Aboe Amin
Mataram	:	Satria Mulya
Pekanbaru	:	C.Y. Boestal
Pontianak	:	Amin Sisworo
Samarinda	:	Sarman Bona Sihotang
Solo	:	Suwondo

Regional Offices

Category IV

Balikpapan	:	Erman Kurnandi
Kupang	:	Budiman Usman
Jember	:	Sunaryo
Kediri	:	Budhi Santoso
Purwokerto	:	Sumarno
Tasikmalaya	:	Sunarko
Palangkaraya	:	Moenandar
Bengkulu	:	Cheppy Sumawijaya
Kendari	:	Mokhammad Dakhlan
Palu	:	Moch. Zaenal Alim

Category V

Batam	:	Bistok W. Ritonga
Sibolga	:	Yasin Effendi
Lhokseumawe	:	Fauzi Abubakar
Ternate	:	Tri Selo

Appendix C.2

ORGANIZATION CHART OF BANK INDONESIA

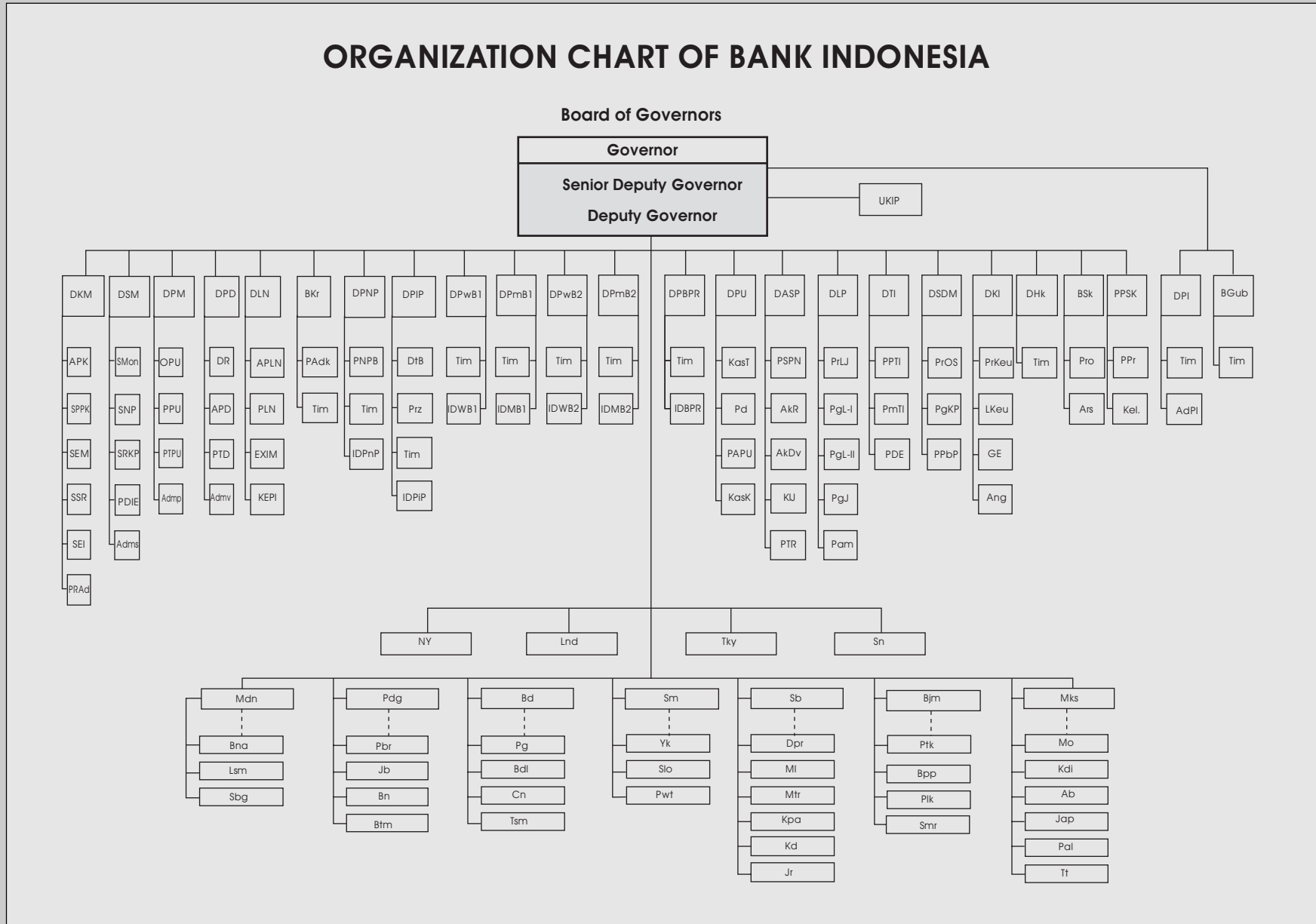

HEAD OFFICE OF BANK INDONESIA

No.	Directorates and Divisions	Abbreviations
I.	DIRECTORATE OF ECONOMIC RESEARCH AND MONETARY POLICY	DKM
	1. Policy Analysis and Planning	APK
	2. Financial Market Structure and Development Studies	SPPK
	3. Macro Economic Studies	SEM
	4. Real Sector Studies	SSR
	5. International Economic and Institution Studies	SEI
	6. Research Library and Administration	PRAAd
II.	DIRECTORATE OF ECONOMIC AND MONETARY STATISTICS	DSM
	1. Monetary Statistics	SMon
	2. Balance of Payment Statistics	SNP
	3. Real Sector and Government Finance Statistics	SRKP
	4. Economic and Monetary Data and Information Processing	PDIE
	5. Administration	Adms
III.	DIRECTORATE OF MONETARY MANAGEMENT	DPM
	1. Money Market Operation	OPU
	2. Money Market Development	PPU
	3. Money Market Settlements	PTPU
	4. Administration	Admp
IV.	DIRECTORATE OF RESERVE MANAGEMENT	DPD
	1. Dealing Room	DR
	2. Reserve Management Analysis	APD
	3. Reserve Settlements	PTD
	4. Administration	Admv
V.	DIRECTORATE OF INTERNATIONAL AFFAIRS	DLN
	1. Foreign Debt Administration and Analysis	APLN
	2. Foreign Debt	PLN
	3. Export and Import	EXIM
	4. International Trade and Economic Cooperation	KEPI
	5. Administration	Adml
VI.	BUREAU OF CREDIT	BKr
	1. Research and Development Team	
	2. Credit Management and Administration	PAdk
VII.	DIRECTORATE OF BANKING RESEARCH AND DEVELOPMENT	DPNP
	1. Teams	
	a. Banking Regulation	
	b. Banking Supervision Development	
	2. Banking Research Bureau	PNPB
	3. Information and Documentation Division of Banking Research and Regulation	IDPhP

No.	Directorates and Divisions	Abbreviations
VIII.	DIRECTORATE OF BANKING LICENSING AND BANKING INFORMATION 1. Teams a. Bank Liquidation b. Deposit Insurance 2. Banking Data 3. Bank Licensing 4. Information and Documentation Division of Bank Licensing and Banking Information	DPIP - DtB Prz IDPiP
IX.	DIRECTORATE OF BANK SUPERVISION 1 1. Bank Supervisor Teams 2. Information and Documentation Division of Bank Supervision 1	DPwB1 - DPWB1
X.	DIRECTORATE OF BANK EXAMINATION 1 1. Bank Examiner Teams 2. Information and Documentation Division of Bank Examination 1	DPmB1 - IDPmB1
XI.	DIRECTORATE OF BANK SUPERVISION 2 1. Bank Supervisor Teams 2. Information and Documentation Division of Bank Supervision 2	DPwB2 - IDPwB2
XII.	DIRECTORATE OF BANK EXAMINATION 2 1. Bank Examiner Teams 2. Information and Documentation Division of Bank examination 2	DPmB2 - IDPmB2
XIII.	DIRECTORATE OF RURAL BANK SUPERVISION 1. Teams a. Rural Bank Supervision b. Rural Bank Examination 2. Information and Documentation Division of Rural Bank Supervision	DPBPR - IDBPR
XIV.	DIRECTORATE OF CURRENCY CIRCULATION 1. Cash Division – Thamrin Office 2. Currency Distribution 3. Currency Planning, Distribution and Administration 4. Cash Division – Kota Office	DPU KasT Pd PAPU KasK
XV.	DIRECTORATE OF ACCOUNTING AND PAYMENT SYSTEM 1. National Payment System Development Bureau 2. Rupiah Accounting 3. Foreign Exchange Accounting 4. Jakarta Clearing 5. Rupiah Settlement	DASP PSPN AkR AkDv KIJ PTR
XVI.	DIRECTORATE OF LOGISTICS AND SECURITY 1. Logistics and Services Planning 2. Logistics Management I 3. Logistics Management II 4. Services Management 5. Security	DLP PriJ PgL-I PgL-II PgJ Pam

No.	Directorates and Divisions	Abbreviations
XVII.	DIRECTORATE OF INFORMATION TECHNOLOGY 1. Information Technology Research and Development Bureau 2. Information Technology Maintenance 3. Electronic Data Processing	DTI PPTI PmTI PDE
XVIII.	DIRECTORATE OF HUMAN RESOURCES 1. Organization and Human Resources Planning Bureau 2. Career Development 3. Recruitment and Counseling	DSDM PrOS PgKP PPbP
XIX.	DIRECTORATE OF FINANCIAL MANAGEMENT 1. Financial Planning 2. Financial Report 3. Salary and Emolument 4. Budget	DKI PrKeu LKeu GE Ang
XX.	DIRECTORATE OF LEGAL AFFAIRS 1. Teams a. Legal Advisor b. Legal Information and Documentation c. Enquiry Point	DHk
XXI.	OFFICE OF SECRETARIATE 1. Protocol 2. Archives	BSk Pro Ars
XXII.	DIRECTORATE OF INTERNAL AUDIT 1. Teams a. Internal Audit Development b. Regulation Analysis c. Audit 2. Administration and Information Division of Internal Audit	DPI - AdPI
XXIII.	OFFICE OF THE GOVERNOR 1. Planning and Monitoring Team 2. Public Relation Office 3. Assistants to the Governor	BGub
XXIV.	SPECIAL UNIT FOR FOR BANKING INVESTIGATION 1. Banking Investigation Teams	UKIP -
XXV.	CENTER OF EDUCATION AND CENTRAL BANKING STUDIES 1. Groups a. Designing and Evaluation b. Researchers 2. Program Conducting Division	PPSK PPr

Regional Offices and Representative Offices		Abbreviations
Regional Offices		
1.	Ambon	Ab
2.	Balikpapan	Bpp
3.	Banda Aceh	Bna
4.	Bandar Lampung	Bdl
5.	Bandung	Bd
6.	Banjarmasin	Bjm
7.	Batam	Btm
8.	Bengkulu	Bn
9.	Cirebon	Cn
10.	Denpasar	Dpr
11.	Jayapura	Jap
12.	Jambi	Jb
13.	Jember	Jr
14.	Kediri	Kd
15.	Kendari	Kdi
16.	Kupang	Kpa
17.	Lhokseumawe	Lsm
18.	Makassar	Mks
19.	Malang	MI
20.	Mataram	Mtr
21.	Medan	Mdn
22.	Menado	Mo
23.	Padang	Pdg
24.	Palangkaraya	Plk
25.	Palembang	Pg
26.	Palu	Pal
27.	Pekanbaru	Pbr
28.	Pontianak	Ptk
29.	Purwokerto	Pwt
30.	Samarinda	Smr
31.	Semarang	Sm
32.	Sibolga	Sbg
33.	Solo	Slo
34.	Surabaya	Sb
35.	Tasikmalaya	Tsm
36.	Ternate	Tt
37.	Yogyakarta	Yk
Representative Offices		
1.	New York	NY
2.	London	Lnd
3.	Tokyo	Tky
4.	Singapore	Sn

Appendix D.1

Condensed Balance Sheet of Bank Indonesia as per December 31, 2000¹⁾ (Billions of Rupiah)

Assets		Liabilities and Equities	
		LIABILITIES	
1. Gold	8,170	1. Currency in Circulation	89,704
2. Foreign Currencies	794	2. Demand Deposits	
3. Special Drawing Rights	306	A. Government	91,298
4. Demand Deposits	5,151	– In Rupiahs	61,677
A. Central Banks	2,950	– In Foreign Exchanges	29,621
B. Correspondent Banks	2,201	B. Banks	41,313
5. Time Deposit at Correspondent Banks	61,538	– In Rupiahs	33,677
6. Marketable Securities	217,662	– In Foreign Exchanges	7,636
A. In Rupiahs	0	C. Other Private Sector	6,485
B. In Foreign Exchanges	217,662	– In Rupiahs	6,283
7. Claims		– In Foreign Exchanges	202
A. On Government	279,185	D. International Financial Institution	105,135
– In Rupiahs	279,061	– In Rupiahs	105,135
– In Foreign Exchanges	124	– In Foreign Exchanges	0
B. On Banks	20,532	3. Bank Indonesia Bills	78,673
– In Rupiahs	18,803	A. In Rupiahs	78,673
– In Foreign Exchanges	1,729	B. In Foreign Exchanges	0
C. On Others	7,279	4. Loans from Government	27,531
– In Rupiahs	7,279	A. In Rupiahs	336
– In Foreign Exchanges	0	B. In Foreign Exchanges	2,165
8. Allowance for Bad Debts	(27,383)	C. Bank Indonesia Debt Note	25,030
9. Equity Participation	0	5. Foreign Borrowings	18,990
10. Other Assets	6,369	6. Other Liabilities	1,299
		TOTAL LIABILITIES	460,429
		EQUITIES	
		1. Capital	2,606
		2. General Reserves	6,431
		3. Statutory Reserves	2,756
		4. Fixed Assets Revaluations Reserve	4,767
		5. Exch. Rate & Foreign Security Revaluation Reserve	79,954
		6. Government Bond Indexation Reserve	18,818
		7. Bank Indonesia Debt Note Indexation Reserve	(476)
		8. Previous Years Surplus (Deficit)	1,773
		9. Current Year Surplus (Deficit)	2,547
		TOTAL EQUITIES	119,175
TOTAL ASSETS	579,604	TOTAL LIABILITIES AND EQUITIES	579,604

¹⁾ Unaudited. The Comprehensive Financial Report of Bank Indonesia in 2000 was submitted to Supreme Audit Authority and The House of Representative on January 31, 2001 to fulfill the prerequisite of article 61 Act No.23, 1999.

Appendix D.2

Surplus Deficit for the period ended December 31, 2000¹⁾ (Billions of rupiah)

REVENUES		
1.	Monetary Operations	46,907
	A. Foreign Exchange Management	35,443
	B. Money Market Activities	52
	C. Loan and Financing	11,412
2.	Payment System Services	39
3.	Banking Services	33
4.	Others	3,093
	A. Other Revenues	162
	B. Allowance for Bad Debts Recovery	2,931
	Total Revenues	50,072
EXPENSES		
1.	Monetary Operations	(19,681)
	A. Formulating and Implementing Monetary Policy	(11,890)
	B. Foreign Exchange Management	(7,791)
2.	Payment System Services	(721)
	A. Currency Circulation	(696)
	B. Payment System Sponsoring	(25)
3.	Banking Supervisions	(132)
4.	General and Administration	(2,436)
	A. General , Administration and Others	(2,253)
	B. Fixed Assets Depreciation	(183)
	Total Expenses :	(22,970)
	Surplus (Deficit) Before Extra-ordinary Items	27,102
	Surplus from Adjustment of Beginning Balance Due Dilligence	-
	Extra-ordinary Expenses	(24,554)
	SURPLUS (DEFICIT)	2,547

¹⁾ Unaudited. The Comprehensive Financial Report of Bank Indonesia in 2000 was submitted to Supreme Audit Authority and The House of Representative on January 31, 2001 to fulfill the prerequisite of article 61 Act No.23, 1999.

Appendix E

REGULATIONS AND IMPORTANT POLICIES IN ECONOMIC AND FINANCE IN 2000

Date	Regulation/Policy	Number
2000		
January		
14	Bank Indonesia issued a regulation on the fit and proper test for controlling shareholders, management and top executives of banks. The fit and proper test is conducted periodically or whenever deemed necessary by Bank Indonesia.	Bank Indonesia Regulation (PBI) Number 2/1/PBI/2000
14	The government issued a decree on the calculation of automotive tax.	Minister of Home Affairs Decree Number 1 of 2000
20	The government issued a regulation on the policy of restructuring and settlement of debt, under IBRA	Coordinating Minister for the Economy Decree Number 01/A/M.EKUIN/01/2000
21	Bank Indonesia issued a regulation on the management and trading of government bonds. The regulation covers among others the related function of Bank Indonesia, the registration of ownership, clearing, bonds settlement, trading mechanism, supervision, and reporting.	Bank Indonesia Regulation (PBI) Number 2/2/PBI/2000
February		
1	Bank Indonesia issued a regulation on the transfer of authority in the managing of Bank Indonesia liquidity credit program to state-owned institutions appointed by the government which includes Bank Rakyat Indonesia, Bank Tabungan Negara, and PT Permodalan Nasional Madani.	Bank Indonesia Regulation (PBI) Number 2/3/PBI/2000
11	Bank Indonesia issued an amendment of Bank Indonesia regulation Number 1/3/PBI/ 1999 on local clearing and inter-bank settlement.	Bank Indonesia Regulation (PBI) Number 2/4/PBI/2000

Date	Regulation/Policy	Number
18	The government issued a decree concerning the regional minimum wages in 26 provinces in Indonesia Ministry of Labor and minimum wages for sectors in 20 provinces in Indonesia	Ministry of Manpower Decree Number Kep-20/Men/2000
21	<p>Bank Indonesia issued a regulation concerning the provision of funds by a bank guaranteed by other banks. The term of the provision of funds in this regulation is the placement of bank funds either in rupiah or foreign exchange, in the form of credit, notes, inter-bank money market, including commitment and contingency. Furthermore, it is also stipulated that the supply of funds to affiliated party for each borrower or group of borrowers guaranteed by other bank is not calculated in the legal lending limit with a maximum amount of 90% of the bank's capital. The provision of funds to non-affiliated party for each borrower or group of borrowers guaranteed by other bank is not calculated in the legal lending limit with maximum amount of:</p> <ul style="list-style-type: none"> a. 70% of bank capital until end of 2001; b. 75% of bank capital during 2002; c. 80% of bank capital since January 1, 2003. <p>The guarantor banks must meet the following requirements:</p> <ul style="list-style-type: none"> a. investment rating; and b. total assets included in the world 200 largest. 	Bank Indonesia Regulation (PBI) Number 2/5/PBI/2000
21	Bank Indonesia issued a regulation on the bank examination procedures.	Bank Indonesia Regulation (PBI) Number 2/6/PBI/2000
23	Bank Indonesia issued a regulation concerning the minimum reserves requirement in rupiah and foreign exchange for commercial banks operating under the Sharia principle. The minimum reserves requirement is 5% of third party funds in rupiah, and 3% of third party funds in foreign exchange. The minimum reserves requirement must be fulfilled daily at the closing of the Bank Indonesia accounting system.	Bank Indonesia Regulation (PBI) Number 2/7/PBI/2000

Date	Regulation/Policy	Number
23	The government issued a regulation concerning the revision of tariff on non-tax revenue imposed within in the general mining sector of the ministry of mineral resources and energy.	Government Decree Number 13 of 2000
23	Bank Indonesia issued a regulation concerning inter-bank money market based on the Sharia principle.	Bank Indonesia Regulation (PBI) Number 2/8/PBI/2000
23	Bank Indonesia issued a regulation concerning the Wadiah promissory notes (A Bank Indonesia notes issued for banks operating under the Islamic Sharia principle).	Bank Indonesia Regulation (PBI) Number 2/9/PBI/2000
25	The government issued a decree cocerning the requirements for the import of CBU vehicles.	Minister of Trade and Industry Decree Number 49/MPP/Kep/2/2000
26	The government issued a Presidential Decree concerning the establishment of the Indonesian Corporate Debt Resolution Team.	Presidential Decree . Number 32 of 2000
28	The government issued a regulation concerning the establishment of Recapitalized Banks Monitoring Team.	Finance Minister Decree Number 51/KMK.017/2000
29	The government issued a regulation ceiling price export of palm oil, crude palm oil, and its derivatives.	Director General of International Trade circular Number 25/DJPLN/II/2000
March 10	The government issued a regulation concerning the distribution of land and building tax income between the central and regional government as follows : a) 10% for the central government b) 90% for regional government	Government Regulation Number 16 of 2000

Date	Regulation/Policy	Number
	<p>The 90 percent share is further divided into:</p> <ul style="list-style-type: none"> a) 16.2% for provincial administration b) 64.8% for district/mayorality administration c) 9% for collection cost 	
21	An Approval of State Revenue and Budget for the year 2000.	Act Number 2 of 2000
21	The government issued a decree concerning the minimum regional wage for The East Kalimantan Province.	Minister of Manpower Decree Number Kep.35/MEN/2000
21	The government issued a decree concerning the minimum regional wage for the Central Sulawesi Province.	Minister of Manpower Decree Number Kep.37/MEN/2000
29	Bank Indonesia issued a regulation concerning the revision of Bank Indonesia regulation Number 1/10/PBI/1999 on the portfolio of government bonds for commercial banks in the recapitalization program.	Bank Indonesia Regulation (PBI) Number 2/10/PBI/2000
29	The government issued a policy on excise tax tariff and floor price for tobacco products.	Finance Minister Decree Number 89/KMK.05/2000
31	The government issued a decree concerning the import tariff relief for the import of raw materials/components for the manufacturing of electronic products.	Finance Minister Decree Number 98/KMK.05/2000
31	Bank Indonesia issued a regulation concerning the determination of bank status and, its transfer to the Indonesian Bank Restructuring Agency (IBRA). The regulation among others stipulates the criteria used in assigning banks under a special surveillance, bank under a recovery process status and the transfer of banks from Bank Indonesia to IBRA, the process of freezing bank's license and the transfer of banks, and the criteria and procedure to decide which banks are not eligible	Bank Indonesia Regulation (PBI) Number 2/11/PBI/2000

Date	Regulation/Policy	Number
31	<p>to join the government blanket guarantee program. The Bank Indonesia regulation also regulates the transfer of bank to IBRA on other reasons including a case in which the bank's bad assets would be transferred to IBRA to be resolved, following agreement between the bank shareholders, and Bank Indonesia and IBRA.</p> <p>In more details, the Bank Indonesia Regulation stipulates that a bank shall be assigned under special surveillance if based on Bank Indonesia appraisal that the bank suffered difficulties as reflected among others in its capital adequacy ratio (CAR) of less than 4% and or non-performing loan (NPL) higher than or equal to 35% of the total lending. The special surveillance status is for a 6-month period for publicly-listed banks and 3-month period for non-listed banks. Meanwhile, the bank shall be assigned a recovery status and shall be transferred to IBRA if the special surveillance period has been surpassed and the bank's CAR remained to be under 4%, but it still has a good prospect to increase the CAR level to 8% at the end of 2001. The time period for IBRA to supervise a bank under a recovery process is 18 months. The transfer of a bank frozen bank to IBRA is based on two criteria: the first, bank under a special surveillance status but its CAR is less than 2% and has no prospect to improve to 8% by end 2001 or if the bank's minimum reserves requirement is already below 0% and can not be settled; the second, the special surveillance status has been surpassed, but the bank's CAR is still below 4% with no prospect of improving, and the bank has not met requirements to be put under the recovery process status. IBRA has 2 years to handle banks under the frozen status.</p> <p>The government regulation concerning the third revision of the Government Regulation Number 17 of 1999 concerning the Indonesian Bank Restructuring Agency (IBRA).</p>	Government regulation Number 18 of 2000

Date	Regulation/Policy	Number
April		
7	The government issued a regulation to impose tax on the Integrated Economic Development Area.	Government Regulation Number 20 of 2000
24	The government issued a regulation on the revision of stamp tariff.	Government Regulation Number 24 of 2000
26	The enactment of Act Number 3 of 2000 concerning the revision of Act Number 7 of 1999 on State Revenue and Expenditure fiscal year 1999/2000	Act Number 3 of 2000
27	<p>Bank Indonesia and the Indonesian Bank Restructuring Agency (IBRA) have ended the bank under recovery-bank take over of Bank Central Asia (BCA). BCA was transferred into IBRA's recovery program in May 1998 as a Bank Take Over. During the process, the bank managed to turn around its performance from a loss position to quite profitable.</p> <p>The government represented by IBRA as the majority shareholder of BCA would continue, the divestment of government shares in BCA. The divestment process, is currently being done through an initial public offering (IPO).</p>	
Mei		
1	The government issued a decree concerning the import tariff relief on the import of machinery, goods and materials for the development of service industry.	Finance Minister Decree Number 135/KMK.05/2000
6	The government issued a regulation concerning the authority of the central government and provinces as autonomous region.	Government Regulation Number 25 of 2000
15	Beginning May 2000 Bank Indonesia will publish a foreign exchange reserves data per April 30, 2000 using the latest Special Data Dissemination Standards concept, which is called International Reserve and Foreign Currency Liquidity (IRFCL).	Bank Indonesia Press Release BI Number 2/79/public relations.

Date	Regulation/Policy	Number
	<p>The standard is used by IMF member countries, pioneered by G7 nations. The new concept changes the way foreign exchange reserves is calculated from the way used under the Gross Foreign Assets (GFA) concept.</p> <p>The difference between IRFCL and GFA lies on the classification of assets and the cross rate used against other currencies. The assets covered in the IRFCL concept are classified as liquid assets (until one year) and is easily tradable. The cross rate used, which initially was based on the exchange rate of March 31, 1998 in the calculation of Net International Reserves (NIR), under the new concept is based on current market rate. The two basic changes will cause Indonesia's Net International Reserves figure to become lower compared to the data which have been published so far.</p>	
16	<p>The Bank Indonesia guarantee is given to creditors if a bank can not fulfill its obligation. The amount of the guarantee shall not exceed the principle plus interest rate and other expenses as detailed in the Master of Loan Agreement. The Bank Indonesia guarantee is effective in accordance with the inter-bank overseas loan installment payment period of 1 (one), 2 (two), 3 (three), 4 (four), 5 (five) and 6 (six) years since the loan has been exchanged with new loan.</p>	Bank Indonesia Regulation (PBI) Number 2/12/PBI/2000
16	<p>Bank Indonesia issued a regulation on the guarantee of international trade financing. To boost the national economic activity particularly international trade, Bank Indonesia on behalf of the government issued a Letter of Guaranty to guarantee the international trade financing provided by banks.</p>	Bank Indonesia Regulation (PBI) Number 2/13/PBI/2000
25	<p>The government issued a decree on the export quota of textile and textile products.</p>	Minister of Trade and Industry decree Number 174/MPP/KEP/5/2000

Date	Regulation/Policy	Number
26	The government issued a decree concerning the Requirement, procedurs, and stipulation of the implementation of the government guarantee on the obligation of commercial banks.	Finance Minister decree Number 179/KMK.017/2000
30	The government issued a decree concerning revision of classification and import tariff reduction on the import of certain products.	Finance Minister decree Number 187/KMK.01/2000
June 2	The government issued a decree concerning the revision of Minister of Trade and Industry on goods whose import mechanism is administered by the government which have been revised several times, lastly by Minister of Trade and Industry decree Number 50/MPP/KEP/2/1999 concerning the revision of the stipulation on the import of completely built up (CBU) vehicles.	Minister of Trade and Industry decree Number 192/MPP/KEP/6/2000
7	The government issued a regulation concerning PERURI (the state bank notes printing company).	Government Regulation Number 34 year 2000
9	Bank Indonesia issued a regulation on the second revision of Bank Indonesia Regulation PBI Number 1/3/PBI/1999 on local clearing arrangement and final settlement of Inter-bank payment transaction on local clearing outcome.	Bank Indonesia Regulation (PBI) Number 2/14/PBI/2000
12	Bank Indonesia issued a regulation concerning the Bank Indonesia board of Number 31/150/KEP/DIR dated November 12, 1998 on credit restructuring. The fulfillment concerning of the legal lending limit, which initially must be completed by banks within 9 months since December 1998, is extended into May 2001. Meanwhile, the deadline of loans which is being restructured via official institutions including the Jakarta Initiative Task Force and or Bank	Bank Indonesia Regulation (PBI) Number 2/15/PBI/2000

Date	Regulation/Policy	Number
	<p>Indonesia Restructuring Committee is extended into the end of December 2002. As a component in the calculation of CAR; Bank Indonesia includes book value loan loss provision in calculating risk-weighted assets for productive assets in the category of special mention status, sub-standard, doubtful, and loss. Initially the calculation of risk-weighted assets did not include book value loan loss provision. The revision is in accordance with the Bank for International Settlement (BIS) standard.</p>	
12	<p>Bank Indonesia issued a regulation concerning the revision The Bank Indonesia Board of Managing Director Decree Number 31/177/KEP/DIR dated December 31, 1998 concerning commercial bank lending limit.</p>	<p>Bank Indonesia Regulation (PBI) Number 2/16/PBI/2000</p>
26	<p>The government issued a decree concerning the revision of regional minimum wage for Jakarta area from Rp 286,000 to Rp 344,357.</p>	<p>Minister of Labor Affairs decree Number KEP-185/MEN/2000</p>
26	<p>The government delayed the implementation of Government Regulation Number 23 of 1998 concerning valued added tax and luxurious tax imposed in the island of Batam.</p>	<p>Government Regulation Number 45 of 2000</p>
28	<p>Bank Indonesia circular concerning the revision of interest rate margin on third party deposits guaranteed by the government:</p> <ol style="list-style-type: none"> 1. interest rate margin on rupiah third party deposits/savings is set at 200 basis point. 2. interest rate margin on foreign exchange deposits/savings is set at 100 basis point. 	<p>Bank Indonesia Circular Letter Number 2/17/DPNP</p>
30	<p>Bank Indonesia will gradually withdraw the Rp 50,000 (Soeharto series) bank notes. However, the Rp50,000 notes will still be valid. The bank notes had been distributed since 1993 and as the replacement for the Soeharto series bank</p>	<p>Bank Indonesia press release Number 2/109/Bgub/public relations</p>

Date	Regulation/Policy	Number
	<p>notes, Bank Indonesia has issued the Rp 50,000 W.R. Soepratman series bank notes . The gradual withdrawal by Bank Indonesia is made by not redistributing the notes which had been returned to Bank Indonesia and replaced it with the W.R. Soepratman series.</p>	
30	<p>As a continuation of the Bank Indonesia transformation program, implemented on July 3, 2000, Bank Indonesia, issued a circular concerning a research agency called Center for Study and Education on Central Bank Issues (PPSK). PPSK will focus more on the development of Bank Indonesia human resources and conduct research related to the function of Bank Indonesia. Research conducted by Bank Indonesia so far focuses on policy implementation, whereas the PPSK will focus on upgrading expertise in the fields of monetary, banking and payment system.</p>	Bank Indonesia Circular Number 2/14/Intern
July		
20	<p>Bank Indonesia issued a regulation on the printing, distribution and withdrawal of rupiah bank notes.</p>	Bank Indonesia Regulation (PBI) Number 2/17/PBI/2000
20	<p>Withdrawal of Rp 10,000 bank notes with emission year 1992 and 1995, Rp 50,000 notes with emission year 1993 and 1995, and Rp 50,000 notes (with plastic material) with emission year 1993.</p>	Bank Indonesia Regulation (PBI) Number 2/18/PBI/2000
August		
4	<p>Calculation of state budget fiscal year 1998/1999.</p>	Act Number 22 of 2000
September		
7	<p>Bank Indonesia issued a regulation concerning the requirements and procedure to provide instructions or written permission to reveal bank secrecy. According to the regulations, banks must keep information about their depositors and deposits confidential, except in the following cases:</p>	Bank Indonesia Regulation (PBI) Number 2/19/PBI/2000

Date	Regulation/Policy	Number
	<ol style="list-style-type: none"> 1. For tax purposes; 2. Settlement of bank loans already transferred to the state auction agency; 3. For court process in a crime case; 4. For court process in a legal suit between bank and its customers; 5. Exchange of information among banks; 6. On written demand and approval of depositors; 7. On demand of the legitimate beneficiary of deceased depositors inheritance 	
11	The government issued a decree concerning the revision of Finance Minister decree Number 891/KMK.05/2000 concerning excise tariff and floor price of tobacco.	Finance Minister decree Number 378/KMK.05/2000
12	The government issued a decree on the export tax of palm oil, CPO and its derivative products. The decree among others stipulates that CPO export tax is set at 5%.	Finance Minister decree Number 387/KMK.017/2000
12	Bank Indonesia issued a regulation concerning short term liquidity facility for commercial banks.	Bank Indonesia Regulation (PBI) Number 2/20/PBI/2000
15	Bank Indonesia has temporarily banned PT Bank Hanvit Indonesia from participating in local clearing activity since September 14, 2000 until further notice due to the closing down of the bank's office at the Jakarta Stock Exchange building following the bombing incident at the building's basement parking lot on September 13, 2000. The temporary ban was a response of Bank Indonesia to the request of Bank Hanvit, which informed the central bank that it could not operate normally following the bombing.	Bank Indonesia press release Number 2/159/Bgub/public relations
18	Bank Indonesia since September 15, 2000 has allowed Bank Hanvit to participate again in local clearing activity in Jakarta.	Bank Indonesia press release Number 2/161/Bgub/public relations

Date	Regulation/Policy	Number
19	Bank Indonesia issued a regulation concerning monthly report of commercial banks.	Bank Indonesia Regulation (PBI) Number 2/21/PBI/2000
19	Bank Indonesia circular concerning the increase of the percentage of government bonds portfolio that may be sold by recapitalized commercial banks. The maximum limit was initially set at 10% and is now increased to 15% of the total government bonds owned by the recapitalized banks.	Bank Indonesia circular Number 2/18/DPM
28	Bank Indonesia on behalf of the government of Indonesia has signed rescheduling agreement on the principal payment of two stand-by loans obtained by the government from syndication of overseas banks in 1994 and 1995. The total amount of debt being restructured is \$340 million.	Bank Indonesia press release Number 2/170/Bgub/public relations
October		
2	Bank Indonesia issued a regulation concerning the requirement to report overseas loans made by banks and non-bank businesses.	Bank Indonesia Regulation (PBI) Number 2/22/PBI/2000
2	The government issued a decree concerning the treatment of bank notes, coins, and raw materials for the production of bank notes and coins as tax object.	Finance Minister decree Number 414/KMK.04/2000
20	Bank Indonesia froze the operation of PT Bank Ratu and Bank Prasadha Utama on October 20, 2000 and transferred them to IBRA for further action in line with the existing regulation.	Decree of Bank Indonesia Senior Deputy Governor Number 2/24/KEP.DGS/2000 and Number 2/25/KEP.DGS/2000
27	The government issued decree concerning finance companies.	Finance Minister decree Number 448/KMK.04/2000
November		
6	Bank Indonesia issued a regulation concerning the fit and proper test.	Bank Indonesia Regulation (PBI) Number 2/23/PBI/2000

Date	Regulation/Policy	Number
10	The government issued a regulation concerning the management and accountability of finances.	Government Regulation Number 106 year 2000
10	Bank Indonesia circular concerning foreign exchange transaction report by non-bank financial institutions.	Bank Indonesia circular Number 2/23/DSM
16	The government issued a decree concerning the export price limit of palm oil, CPO and its derivative products.	Director general of international tradedecree Number 280/DJPLN/XI/2000
17	As a moral responsibility of Bank Indonesia to officials, which is expected to resolve the BLBI case, with full consciousness and without pressure from anyone, Senior Deputy Governor Anwar Nasution, and several deputy governors including Miranda S. Goeltom, Dono Iskandar Djojsubroto, Achwan and Burhanuddin Abdullah submitted their resignation from the central bank.	Bank Indonesia press release Number 2/201/Bgub/public relations
17	Bank Indonesia circular concerning Bank Indonesia Real Time Gross Settlement (RTGS), which is an inter-bank electronic fund transfer system.	Bank Indonesia circular Number 2/24/DASP
17	<p>Bank Indonesia circular concerning the cost of the utilization of Bank Indonesia Real Time Gross Settlement System. There are two type of costs :</p> <ul style="list-style-type: none"> - cost of transaction; - cost of extending operational hours. <p>The size of the transaction cost is as follows:</p> <ul style="list-style-type: none"> - single credit transaction cost at Rp 10,000 per transaction; - multiple credit transaction at Rp 50,000 per transaction; - administrative message cost at Rp 2,500 per administrative message <p>The cost for extending operational hours is Rp 5 million for the first 30 minutes and Rp 10 million for the second 30 minutes.</p>	Bank Indonesia circular Number 2/25/DASP

Date	Regulation/Policy	Number
17	Bank Indonesia issued a regulation concerning the relationship between demand deposit account of Bank Indonesia and external parties.	Bank Indonesia Circular Number 2/25/DASP
17	Central bank leaders and monetary authorities of ASEAN countries and Finance Minister of Brunei Darussalam agreed on November 17, 2000 to increase the amount of short term liquidity support facility from \$200 million to \$1 billion for its members facing short term balance of payment difficulties. The members include Indonesia, Malaysia, Philippines, Singapore, Thailand, Brunei, Laos, Cambodia, Vietnam and Myanmar. With the availability of the facility, known as ASEAN Swap Arrangements (ASA), ASEAN member countries will have access to obtain short term liquidity facility (maximum 6 months) with low interest rate.	
23	The release and distribution of Rp 1,000 bank notes emission year 2000.	Bank Indonesia Regulation (PBI) Number 2/25/PBI/2000
December		
8	Bank Indonesia circular concerning the increase of the percentage of government bonds portfolio that may be sold by recapitalized banks. The percentage of bonds that may be sold, was previously set at a 15.0% limit, and is now increased to a 25.0 % limit.	Bank Indonesia circular Number 2/26/DPM
13	Bank Indonesia issued a regulation concerning inter-day liquidity facility for banks.	Bank Indonesia Regulation (PBI) Number 2/26/PBI/2000
15	Bank Indonesia issued a regulation concerning commercial banks, covering aspects such as license, capital, ownership, and bank management.	Bank Indonesia Regulation (PBI) Number 2/27/PBI/2000

Appendix F

Summary on Comparison on Prudential Regulations (CAR, RWA, AEAL, LLL, and NOP)

No.	Description	Old Regulation	New Regulation
1.	Capital Adequacy Ratio	SK DIR BI No.26/20/KEP/DIR May 29, 1993	SK DIR BI No.31/146/KEP/DIR November 12, 1998
	<ul style="list-style-type: none"> - The minimum ratio - Formula - Capital 	8%	4%
	<ul style="list-style-type: none"> - Risk Weighted Assets (RWA) 	Capital/Risk Weighted Assets x 100% <ul style="list-style-type: none"> - Consisting of core capital and complementary capital - Core capital consist of paid up capital, share agio, donated capital, general reserves, special reserves, retained earnings, profits from past years, profits from the current year (50%) subtracted by goodwill and losses from the current year. - Supplementary capital consists of reserves from revaluation of fixed assets, allowance for possible earning assets losses (maximum of 1.25% of total risk weighted assets), loan capital and subordinated loans (maximum of 50% of core capital). 	Capital/Risk Weighted Assets x 100% <ul style="list-style-type: none"> - Consisting of core capital and complementary capital - Core capital consist of paid up capital, share agio, donated capital, general reserves, special reserves, retained earnings, profits from past years, profits from the current year (50%) subtracted by goodwill and losses from the current year. - Supplementary capital consists of reserves from revaluation of fixed assets, allowance for possible earning assets losses (maximum of 1.25% of total risk weighted assets), loan capital and subordinated loans (maximum of 50% of core capital).
	Earning Assets Quality	SK DIR BI No.30/267/KEP/DIR February 27,1998	SK DIR BI No.31/147/KEP/DIR November 12, 1998
2.	<ul style="list-style-type: none"> - Assets value 	<ul style="list-style-type: none"> - Earning Assets consists of credits and securities. 	<ul style="list-style-type: none"> - Earning Assets (credits, securities, placement of funds in other banks, and equity participation) and off-balance sheet transactions.

No.	Description	Old Regulation	New Regulation
	<ul style="list-style-type: none"> <li data-bbox="300 336 459 368">– Classification <li data-bbox="300 449 528 480">– Base for judgement 	<ul style="list-style-type: none"> <li data-bbox="628 336 1011 406">– Current, Special Mention, Substandard, Doubtful, and Loss <li data-bbox="628 449 1011 629">– For credits, there are no arrears in installments on principal, arrears in interest, or overdrafts due to drawing of funds; and prospect of borrower business. <li data-bbox="628 672 1011 742">– For securities, based on the possibility of return/repayment. 	<ul style="list-style-type: none"> <li data-bbox="1043 336 1426 406">– Current, Special Mention, Substandard, Doubtful, and Loss <li data-bbox="1043 449 1426 587">– Business prospects, financial condition with emphasis on the borrower's cash flow, and repayment capacity <li data-bbox="1043 672 1426 885">– For credits and off-balance sheet transactions in the amount of not more than Rp350 million shall be based only on the provisions for payment of debt principal and interest.
3.	<p data-bbox="300 938 596 1008">Allowance for Earning Assets Losses</p> <ul style="list-style-type: none"> <li data-bbox="300 1051 596 1121">– Required Allowance for Earning Assets 	<p data-bbox="628 938 916 1008">SK DIR BI No.30/268/KEP/DIR February 27, 1998</p> <ul style="list-style-type: none"> <li data-bbox="628 1051 1011 1157">– General Provision shall amount to not less than 1% of total earning assets <li data-bbox="628 1274 1011 1827">– Special Provision shall amount to not less than : <ul style="list-style-type: none"> <li data-bbox="644 1349 1011 1381">a. for credit : <ul style="list-style-type: none"> <li data-bbox="660 1391 1011 1498">– 5% of earning assets classified as Special Mention after deduction for cash collateral <li data-bbox="660 1508 1011 1615">– 15% of earning assets classified as Substandard after deduction for cash collateral <li data-bbox="660 1625 1011 1732">– 50% of earning assets classified as Doubtful after deduction for cash collateral <li data-bbox="660 1742 1011 1827">– 100% earning assets classified as Loss after deduction for cash collateral 	<p data-bbox="1043 938 1299 1008">SK DIR BI No.31/148/DIR November 12, 1998</p> <ul style="list-style-type: none"> <li data-bbox="1043 1051 1426 1232">– General Provision shall amount to not less than 1% of earning assets classified as Current, excluding Bank Indonesia Certificates and Government Bonds <li data-bbox="1043 1274 1426 1753">– Special Provision shall amount to not less than : <ul style="list-style-type: none"> <li data-bbox="1059 1349 1426 1419">– 5% of earning assets classified as Special Mention <li data-bbox="1059 1430 1426 1536">– 15% of earning assets classified as Substandard after deduction for collateral value. <li data-bbox="1059 1547 1426 1653">– 50% of earning assets classified as Doubtful after deduction for collateral value <li data-bbox="1059 1664 1426 1753">– 100% earning assets classified as Loss after deduction for collateral value

No.	Description	Old Regulation	New Regulation
4.	<p>Legal Lending Limit</p> <ul style="list-style-type: none"> - The coverage of LLL - Definition - LLL for connected parties - LLL for non-connected parties - The excess over LLL 	<p>SK DIR BI No.26/21/KEP/DIR May 29, 1993</p> <ul style="list-style-type: none"> - Provision of funds subject to the LLL are extension of credit facilities, provision of guarantee facilities, purchase of securities and similiar undertakings such as claims takeover by a bank in the course of factoring - LLL is the maximum limit of provision of funds that a bank is permitted to undertake towards a certain debtor or group of debtors - For one debtor or as a whole, LLL is a maximum of 10% of bank capital - For one debtor or a group of debtors, LLL is a maximum of 20% of bank capital - No distinction is made between violating and exceeding the LLL 	<p>SK DIR BI No.31/177/KEP/DIR December 31, 1998</p> <ul style="list-style-type: none"> - Provision of funds subject to the LLL are credits, securities, placements of funds in other banks, equity participation and off-balance sheet transaction - LLL is the percentage ratio of maximum permitted provision of funds in comparison to bank capital - For individual debtor or a group of debtors, LLL shall not exceed 10% of capital - For individual debtor or a group of debtors, LLL shall be not more than: <ul style="list-style-type: none"> - 30% of capital since 31 Dec 1998 until 31 Dec 2001 - 25% of capital throughout the year 2002 - 20% of capital commencing from January 1, 2003. $\left[\frac{\text{Credit extended at reporting date}}{\text{Capital at reporting date}} \times 100\% \right] - \text{LLL}$ <ul style="list-style-type: none"> - Supply of funds at date of report/ capital at date of report times 100% minus LLL - Lending in excess of the LLL arising from the exchange rate fluctuation and/or the reduction in respect of previously extended Provision of Funds shall not be catego-

No.	Description	Old Regulation	New Regulation
			<p>rized as violation of LLL, so that no sanction is imposed. However, action plan to resolve the excess LLL is required.</p> <ul style="list-style-type: none"> - Supply of funds at date of report/ capital at the time credit was channelled times 100% minus LLL
5.	<p>Violation of LLL</p> <ul style="list-style-type: none"> - Net Open Position (NOP) - Definition - The maintenance of NOP 	<ul style="list-style-type: none"> - Provision of Funds exceeding the maximum LLL <p>SK DIR BI No.24/50/KEP/DIR November 20, 1991</p> <ul style="list-style-type: none"> - NOP is the difference between assets and liabilities in foreign currency recorded on on-balance sheet and/or off- balance sheet. <ul style="list-style-type: none"> - Maximum NOP for each foreign currency is 25% of capital - Maximum NOP for off-balance sheet item is 20% off-capital - Maximum NOP for overall positions is 20% of capital 	$\left[\frac{\text{Credit extended at the date of effectiveness}}{\text{Capital at the date of effectiveness}} \times 100\% \right] - \text{LLL}$ <p>SK DIR BI No.31/178/KEP/DIR December 31, 1998</p> <ul style="list-style-type: none"> - NOP is the absolute value of the sum of : <ul style="list-style-type: none"> - net difference between assets and liabilities in all foreign currencies recorded on the balance sheet; plus - net difference between claims and liabilities, comprising both commitments and contingencies, in all foreign currencies recorded in off-balance sheet accounts, all of which are expressed in rupiahs - NOP shall be maintained at not more than 20% of capital, and shall be calculated on a consolidated basis for all domestic and overseas branch offices - The bank shall maintain its intra day position in accordance with prudential principle

Table 1
Gross Domestic Product by Expenditure
(Billions of Rupiah)

Type of expenditure	1996	1997	1998	1999*	2000**
Constant 1993 market prices					
Consumption	288,697.6	308,816.9	286,850.6	299,084.5	310,725.2
Private	257,016.2	277,116.1	260,022.7	272,070.2	281,957.4
Government	31,681.4	31,700.8	26,827.9	27,014.3	28,767.8
Gross domestic fixed capital formation	128,698.6	139,725.6	93,604.7	75,467.9	88,984.5
Change in stock ¹⁾	5,873.1	3,341.7	-6,386.9	-8,571.9	-16,138.3
Exports of goods and services	112,391.4	121,157.9	134,707.2	92,123.6	106,917.5
less Imports of goods and services	121,862.8	139,796.1	132,400.7	78,546.4	92,822.6
Gross Domestic Product	413,797.9	433,246.0	376,374.9	379,557.7	397,666.3
Net factor income from abroad	-12,486.8	-15,462.9	-27,965.4	-22,145.1	-24,592.7
Gross National Product	401,311.1	417,783.1	348,409.5	357,412.6	373,073.6
less Net indirect tax	22,469.6	26,100.1	1,858.9	6,112.6	-11,666.1
less Depreciation	20,689.9	21,662.4	18,818.8	18,978.0	19,883.3
National Income	358,151.6	370,020.6	327,731.8	332,322.0	364,856.4
Current market prices					
Consumption	372,393.6	430,122.7	702,239.5	885,814.6	958,776.8
Private	332,094.4	387,170.7	647,823.6	813,183.3	867,997.1
Government	40,299.2	42,952.0	54,415.9	72,631.3	90,779.7
Gross domestic fixed capital formation	157,652.7	177,686.1	243,043.4	240,322.2	313,915.2
Change in stock ¹⁾	5,800.4	21,615.1	-82,716.1	-105,063.3	-83,319.2
Exports of goods and services	137,533.3	174,871.3	506,244.8	390,560.1	497,518.9
less Imports of goods and services	140,812.0	176,599.8	413,058.1	301,654.1	396,207.5
Gross Domestic Product	532,568.0	627,695.4	955,753.5	1,109,979.5	1,290,684.2
Net factor income from abroad	-14,272.2	-18,355.0	-53,893.7	-78,896.7	-89,256.4
Gross National Product	518,295.8	609,340.4	901,859.8	1,031,082.8	1,201,427.8
less Net indirect tax	28,918.9	37,828.7	6,480.5	17,950.1	-37,820.3
less Depreciation	26,628.4	31,384.8	47,787.7	55,498.9	64,534.3
National Income	462,748.5	540,126.9	847,591.6	957,633.8	1,174,713.8
Memorandum items :					
Per capita Gross Domestic Product					
In thousands of rupiah	2,142.1	2,212.5	1,896.0	1,894.7	1,954.6
In dollars	1,177	118	491	703.0	782.5
Per capita Gross National Product					
In thousands of rupiah	2,077.4	2,133.5	1,755.1	1,784.1	1,833.7
In dollars	1,145	1,086	463	653.0	728.4
Per capita National Income					
In thousands of rupiah	1,854.0	1,889.6	1,651.0	1,658.9	1,793.4
In dollars	1,023	962	436	606.5	712.2

1) Residual
Source : BPS - Statistics Indonesia

Table 2
Gross Domestic Product by Sector
(Billions of Rupiah)

Sector	Constant 1993 market prices					Current market prices				
	1996	1997	1998	1999*	2000**	1996	1997	1998	1999*	2000**
Agriculture, livestock, forestry, and fishery	63,827.8	64,468.0	63,609.5	65,339.1	66,431.5	88,791.8	101,009.4	172,827.6	216,913.6	218,397.6
Food crops	33,647.0	32,688.4	33,350.4	33,970.4	34,302.3	47,622.1	52,189.4	91,346.0	115,134.9	110,640.6
Non-food crops	10,354.9	10,496.6	10,501.8	10,740.6	10,908.8	14,434.6	16,447.3	33,289.6	36,691.7	34,784.5
Livestock and products	7,133.3	7,483.1	6,439.7	6,869.2	7,059.5	9,523.8	11,688.2	15,743.6	23,939.4	27,507.3
Forestry	6,444.1	7,189.8	6,580.7	6,299.0	6,410.8	8,170.5	9,806.5	11,700.5	13,839.7	15,077.7
Fishery	6,248.5	6,610.1	6,736.9	7,459.9	7,750.1	9,040.8	10,878.0	20,747.9	27,307.9	30,387.5
Mining and quarrying	37,739.4	38,538.2	37,474.0	36,571.8	37,423.2	46,088.1	55,561.9	120,328.5	109,974.2	166,563.1
Crude petroleum and natural gas	24,062.8	23,919.8	23,340.1	22,136.8	22,230.1	28,118.3	34,036.7	74,883.7	71,847.2	123,409.8
Mining (excl. oil and gas)	7,267.6	7,645.6	9,678.0	10,018.1	10,482.0	9,097.8	11,192.4	35,459.9	27,668.6	31,384.9
Quarrying	6,408.9	6,972.8	4,455.9	4,416.9	4,711.1	8,872.0	10,332.8	9,984.9	10,458.2	11,768.4
Manufacturing	102,259.7	107,629.7	95,320.6	98,949.4	105,085.1	136,425.9	168,178.0	238,897.1	287,702.7	336,053.2
Oil and gas	10,863.9	10,650.3	11,042.2	11,688.1	11,571.9	14,194.3	15,621.9	33,172.4	34,541.7	49,932.2
Petroleum and refinery	6,291.5	5,925.5	6,310.0	6,606.6	7,068.7	8,340.1	8,116.1	15,092.2	16,216.5	21,823.8
LNG	4,572.4	4,724.8	4,732.3	5,081.5	4,503.2	5,854.2	7,505.8	18,080.2	18,325.2	28,108.4
Non-oil and gas	91,395.8	96,979.4	84,278.4	87,261.3	93,513.2	122,231.6	152,556.1	205,724.7	253,161.0	286,121.0
Electricity, gas, and water supply	4,876.8	5,479.9	5,646.1	6,112.9	6,649.5	6,892.6	7,832.4	11,283.1	13,429.0	15,072.4
Construction	32,923.7	35,346.4	22,465.3	22,825.5	23,788.7	42,024.8	46,678.8	61,761.6	74,496.4	92,175.9
Trade, hotels, and restaurants	69,475.0	73,523.8	60,130.7	60,195.1	63,621.2	87,137.2	99,581.9	146,740.1	176,663.7	196,049.5
Wholesale and retail trade	55,513.5	58,842.3	47,845.9	47,694.2	50,456.7	69,375.4	77,543.3	116,688.5	141,098.4	156,323.8
Hotels and restaurants	13,961.5	14,681.6	12,284.8	12,500.9	13,164.5	17,761.9	22,038.6	30,051.6	35,564.9	39,725.7
Transportation and communication	29,701.1	31,782.5	26,975.1	26,772.1	29,284.0	34,926.3	38,530.9	51,937.2	55,189.6	64,550.1
Transportation	24,444.6	25,609.1	20,503.8	19,737.6	21,430.5	29,246.4	31,497.6	41,837.2	42,735.7	49,336.7
Communication	5,256.5	6,173.4	6,471.3	7,034.5	7,853.5	5,679.9	7,033.3	10,100.0	12,453.9	15,213.4
Financial, rental, and business services	36,384.2	38,543.0	28,278.7	26,147.8	27,373.4	43,981.9	54,360.3	69,891.7	70,641.9	80,047.2
Banks ¹⁾	18,886.9	19,956.0	13,173.0	11,765.0	12,403.1	21,853.6	25,205.2	31,710.2	30,529.1	34,901.1
Rental and business services	17,497.3	18,587.0	15,105.7	14,382.8	14,970.3	22,128.3	29,155.1	38,181.5	40,112.8	45,146.1
Services	36,610.2	37,934.5	36,475.0	37,184.0	38,009.6	46,299.4	55,962.0	82,102.5	104,968.7	121,775.3
Public administration	23,338.4	23,616.5	21,887.5	22,250.6	22,555.1	29,752.9	32,127.9	40,641.0	56,745.0	69,460.2
Private	13,271.7	14,318.0	14,587.5	14,933.4	15,454.5	16,546.5	23,834.1	41,445.8	48,223.7	52,315.1
GROSS DOMESTIC PRODUCT	413,797.9	433,245.9	376,374.9	379,557.7	397,666.3	532,568.1	627,695.6	989,611.6	1,109,979.5	1,290,684.2
Non-oil and gas	378,871.2	398,675.8	341,992.5	345,732.8	363,864.2	490,255.5	578,037.0	881,555.5	1,003,590.7	1,117,342.3
Oil and gas	34,926.7	34,570.1	34,382.4	33,824.9	33,802.1	42,312.6	49,658.6	108,056.1	106,388.8	173,342.0

1) Incl. non-bank financial institutions and financial supporting services.
Source : BPS - Statistics Indonesia

Table 3
Terms of Trade Effect on Gross Domestic Product
(Billions of Rupiah)

Item	1996	1997	1998	1999*	2000 ¹⁾
1. Exports of goods and services at current market prices	137,533.3	174,871.3	506,244.8	390,560.1	497,518.9
2. Exports of goods and services at constant 1993 market prices	112,391.4	121,157.9	134,707.2	92,123.6	106,917.5
3. Export deflator [(1 : 2) x 100]	122.4	144.3	375.8	424.0	465.3
4. Imports of goods and services at current market prices	140,812.0	176,599.8	413,058.1	301,654.1	396,207.5
5. Imports of goods and services at constant 1993 market prices	121,862.8	139,796.1	132,400.7	78,546.4	92,822.6
6. Import deflator [(4 : 5) x 100]	115.5	126.3	312.0	384.0	426.8
7. Terms of trade index [(3 : 6) x 100]	105.9	114.3	120.5	110.4	109.0
8. Changes in terms of trade index (%)	2.0	7.9	5.4	-8.4	-1.2
9. Real import capacity of export [(1 : 6) x 100]	119,025.3	138,427.8	162,270.6	101,696.2	116,557.6
10. Terms of trade effect (9 - 2)	6,633.9	17,269.9	27,563.4	9,572.6	9,640.1
11. Changes in terms of trade effect (%)	64.2	160.3	59.6	-65.3	0.7
12. GDP at constant 1993 market prices	413,797.9	433,245.9	376,374.9	379,557.7	397,666.3
13. Changes in GDP at constant 1993 market prices (%)	7.8	4.7	-13.1	0.8	4.8
14. Gross Domestic Income (10 + 12)	-407,164.0	-415,976.0	-348,811.5	-369,985.1	-388,026.2
15. Changes in Gross Domestic Income (%)	7.2	2.2	-16.1	6.1	4.9

1) Data up to Quarter III/2000
Source : BPS - Statistics Indonesia (processed)

Table 4
Selected Agricultural Products
(Thousands of Tonnes)

Product	1996	1997	1998	1999	2000 ¹⁾
Food crops					
Rice	33,217	32,095	32,004	33,063	32,953
Corn	9,307	8,771	10,059	9,204	9,156
Cassava	17,002	15,134	14,728	16,459	15,317
Sweet potatoes	2,018	1,847	1,928	1,666	1,631
Peanuts	738	688	691	660	710
Soybeans	1,517	1,357	1,306	1,383	1,046
Mung beans	301	262	303	265	269
Estate crops					
Rubber	1,574	1,553	1,662	1,715	1,752
Smallholder	1,193	1,175	1,243	1,295	1,324
Large estate	381	378	419	420	428
Copra	2,761	2,704	2,778	2,789	2,778
Palm oil	4,899	5,380	5,640	5,989	6,257
Palm kernels	1,085	1,229	1,284	1,370	1,433
Sugarcane	2,094	2,192	1,488	1,489	1,841
T e a	169	154	167	162	151
Smallholder	34	33	34	34	29
Large estate	135	121	133	128	122
Coffee	459	428	515	511	511
Smallholder	436	396	470	466	466
Large estate	23	32	45	45	45
Tobacco	151	210	105	105	105
Smallholder	148	206	102	102	102
Large estate	3	3	2	2	2
Cloves	60	59	67	68	68
Cacao	374	330	449	461	471
Forestry					
Logs ²⁾	26,069	29,920	18,728
Livestock					
Meat	1,632	1,559	1,490
Eggs	780	761	579
Milk (millions of litres)	441	424	434
Fishery					
S e a	3,503	3,482	3,616
Inland	1,017	1,099	1,145

1) Projection figures of Quater III/2000

2) Fiscal year, in thousands of cubic metres

Source : - Ministry of Agriculture
- Ministry of Forestry and Plantation

Table 5
Production, Harvested Area, and Average Production of Paddy and Secondary Crops

Description	1996	1997	1998	1999	2000 ¹⁾
Production (thousands of ton)					
Paddy ²⁾	51,102	49,377	49,237	50,866	50,696
Corn (kernel)	9,307	8,771	10,059	9,204	9,156
Cassava	17,002	15,134	14,728	16,459	15,317
Sweet potatoes	2,018	1,847	1,928	1,666	1,631
Peanuts	738	688	691	660	710
Soybeans	1,517	1,357	1,306	1,383	1,046
Mung beans	301	262	303	265	269
Harvested area (thousands of hectares)					
Paddy ²⁾	11,570	11,141	11,730	11,963	11,608
Corn (kernel)	3,744	3,335	3,834	3,456	3,374
Cassava	1,415	1,243	1,205	1,350	1,261
Sweet potatoes	212	195	201	172	171
Peanuts	689	628	650	625	673
Soybeans	1,279	1,119	1,091	1,151	860
Mung beans	331	294	338	298	302
Average production (quintal per hectare)					
Paddy ²⁾	51,1	44,3	41,9	42,5	43,7
Corn (kernel)	24,9	26,1	26,5	26,6	27,1
Cassava	120,2	121,7	122,0	121,9	121,5
Sweet potatoes	95,3	94,5	97,0	96,7	95,7
Peanuts	10,7	11,0	10,6	10,6	10,5
Soybeans	11,9	12,1	11,9	12,0	12,2
Mung beans	9,1	8,9	9,0	8,9	8,9

1) Data up to September 2000

2) Dry unhusked rice

Source : Ministry of Agriculture

Table 6
Selected Mining and Quarrying Products

Product	Unit	1996	1997	1998	1999	2000 ¹⁾
Crude oil	millions of barrels	582.7	576.9	568.8	545.7	386.7
Natural gas	billions of cubic feet	3,164.0	3,165.7	2,978.7	3,063.4	2,138.4
Tin	thousands of ton	51.0	55.2	54.0	47.8	36.7
Coal	thousands of ton	50,332.0	54,608.4	60,321.0	64,602.1	35,638.4
Copper (concentrate)	thousands of ton	1,758.9	1,817.9	2,640.0	2,645.2	2,270.5
Nickel						
Nickel ore	thousands of ton	3,426.9	2,829.9	3,233.4	3,235.3	1,881.8
Ferro-nickel (ingot)	thousands of ton	46.7	48.7	41.5	44.1	34.9
Ferro-nickel (Ni content)	thousands of ton	9.6	10.0	8.5	9.4	7.9
Nickel matte	thousands of ton	43.5	33.7	35.7	45.9	43.9
Bauxite	thousands of ton	842.0	808.7	1,055.6	1,116.3	885.0
Iron sand	thousands of ton	425.1	487.4	560.5	562.3	342.1
Gold	kilograms	83,564.1	89,978.7	124,018.7	129,032.1	74,290.6
Silver	kilograms	255,404.0	279,160.5	348,973.8	292,331.0	114,245.0

1) Data up to September 2000
Source : Ministry of Mining and Energy

Table 7
PLN Electric Power Installed Capacity
(Millions of KWH)¹⁾

Year	PLN	Non-PLN	Total
1995/96	59,830	1,281	61,111
1996/97	67,356	1,649	69,005
1997/98	68,975	1,870	70,845
1998	74,585	2,832	77,417
1999	78,350	3,990	82,340
2000

1) Only those distributed by PLN to public
Source : State Electricity Corporation (PLN)

Table 8
Regional Daily Minimum Wage by Province
(Rupiah)

Province	1996	1997	1998	1999	2000
Aceh	3,850	4,270	4,900	5,700	8,833
North Sumatera	4,600	5,030	5,800	7,000	8,467
West Sumatera	3,600	3,970	4,567	5,333	6,667
Riau	4,600	5,050	5,800	7,267	10,000
Batam	7,350	7,830	9,000	9,667	14,167
Jambi	3,600	3,980	4,583	5,000	5,767
South Sumatera	3,850	4,250	5,183	5,850	6,533
Bengkulu	3,850	4,250	4,883	5,000	5,777
Lampung	3,850	4,200	4,833	5,333	6,400
Jakarta	5,200	5,750	6,617	7,700	11,475
West Java	4,663	5,120	5,892	6,958	7,667
Central Java	3,400	3,770	4,333	5,100	6,167
Yogyakarta	3,200	3,550	4,083	4,333	6,483
East Java	3,740	4,150	4,767	5,683	7,150
Bali	4,250	4,720	5,417	5,883	6,343
West Nusa Tenggara	3,250	3,600	4,133	4,833	6,000
East Nusa Tenggara	3,200	3,550	4,083	4,767	6,133
East Timor	4,200	4,600	5,283	6,100	–
West Kalimantan	3,800	4,220	4,850	5,833	7,600
Central Kalimantan	4,150	4,600	5,283	6,500	9,500
South Kalimantan	3,800	4,170	4,800	5,533	6,667
East Kalimantan	4,600	5,100	5,867	6,467	7,767
North Sulawesi	3,600	3,930	4,517	5,167	6,200
Central Sulawesi	3,200	3,550	4,083	5,000	6,767
South Sulawesi	3,400	3,750	4,317	4,933	6,667
South East Sulawesi	3,650	4,030	4,633	5,333	7,000
Maluku	4,100	4,530	5,217	6,000	6,000
Irian Jaya	5,150	5,670	6,517	7,500	10,500
Average ¹⁾	3,939	4,347	5,009	5,782	7,328
Average ²⁾	4,061	4,471	5,151	5,921	7,581
Changes (%) ³⁾	10.38	10.35	15.24	15.43	26.74

1) Excluding Batam

2) Including Batam

3) Excluding Batam

Source : Ministry of Manpower and Transmigration

Table 9
Approved Domestic Investment Projects by Sector
(Billions of Rupiah)

Sector	1996	1997	1998	1999	2000 ²⁾	Total ¹⁾ 1968 to 2000	
						Value	Project (units)
Agriculture, forestry, and fishery	16,072.1	14,807.7	5,315.1	2,408.3	3,559.4	88,020.7	1,711
Agriculture	15,284.4	13,737.5	4,757.9	1,614.8	2,816.0	70,944.4	1,094
Forestry	45.6	165.5	542.9	749.3	9.1	6,608.7	301
Fishery	742.1	904.7	14.3	44.2	734.3	10,467.6	316
Mining	460.1	126.3	116.3	174.0	34.1	5,974.4	172
Manufacturing	59,217.7	79,334.3	44,908.0	46,747.5	11,516.8	580,991.0	6,561
Food	13,748.3	13,048.6	6,711.8	12,729.9	3,963.9	153,704.9	990
Textile	3,365.8	6,831.3	1,137.6	2,561.5	1,683.4	56,017.6	1,358
Wood	1,128.9	762.2	1,971.9	1,229.0	145.3	19,342.0	816
Paper	12,763.9	11,841.9	12,754.1	20,244.1	1,598.3	101,120.1	423
Chemical and pharmaceutical	13,392.7	22,497.2	15,583.2	2,480.9	2,476.4	122,656.5	1,350
Non-metal mineral	7,964.8	11,638.7	3,469.0	70.4	553.1	63,561.2	436
Basic metal	4,460.7	8,021.5	1,786.3	6,354.2	187.7	33,437.8	211
Metal products	2,375.9	4,683.9	960.9	1,070.7	908.7	30,024.3	873
Others	16.7	9.0	533.2	6.8	...	1,126.6	104
Construction	1,550.0	877.0	1,992.0	395.1	449.1	9,569.2	170
Hotel	5,019.3	2,587.9	1,150.4	1,379.9	29.2	32,676.8	717
Transportation	3,065.0	4,649.4	3,260.5	225.3	629.5	26,151.8	1,004
Real estate and office buildings	9,425.7	4,300.5	1,547.5	995.5	292.6	37,540.0	369
Other services	5,905.3	13,189.8	2,459.5	1,226.3	985.8	28,715.4	387
T o t a l	100,715.2	119,872.9	60,749.3	53,551.9	17,496.5	809,639.3	11,091

1) From July 1968 to December 2000, after taking into account cancellation and shifting of projects from foreign to domestic investment

2) at the end of July 2000

Source : Investment Coordination Board (BKPM)

Tabel 10
Approved Domestic Investment Projects by Province
 (Billions of Rupiah)

Province	1996	1997	1998	1999	2000 ²⁾	Total ¹⁾ 1968 to 2000	
						Value	Project (units)
Java and Madura	43,772.3	63,680.8	18,871.5	22,126.8	9,450.0	401,423.9	7,419
Jakarta	14,395.5	8,553.5	4,289.7	1,260.5	1,262.4	71,339.3	1,841
West Java	19,213.5	37,423.5	8,117.1	18,393.9	5,673.5	221,414.4	3,434
Central Java	3,366.9	5,764.2	2,574.9	849.6	1,066.8	36,884.6	758
Yogyakarta	222.5	235.6	6.0	34.6	86.8	2,053.4	127
East Java	6,573.9	11,704.0	3,883.8	1,588.2	1,360.5	69,732.2	1,259
Sumatera	24,033.6	33,561.7	10,669.4	14,746.3	5,175.2	239,389.2	1,677
Aceh	1,474.8	1,114.1	1,297.3	94.2	889.3	9,435.6	135
North Sumatera	2,364.0	3,395.5	1,101.5	1,079.4	326.8	15,841.5	356
West Sumatera	3,066.7	522.6	336.8	597.6	482.3	90,401.7	137
Riau	8,854.8	11,862.4	4,925.1	9,091.5	2,333.2	61,807.6	470
Jambi	925.5	9,793.5	1,429.4	3,001.7	832.5	28,618.3	90
South Sumatera	5,024.1	5,391.4	882.7	149.3	10.0	19,123.8	251
Bengkulu	404.7	630.7	4.0	121.4	108.0	3,013.6	58
Lampung	1,919.0	851.5	692.6	611.2	193.1	11,147.1	180
Kalimantan	18,432.4	13,935.7	11,966.6	5,359.5	974.7	77,561.5	845
West Kalimantan	9,316.4	3,825.9	416.9	222.6	9.1	20,110.6	253
Central Kalimantan	2,182.9	1,688.0	9,093.4	3,561.4	526.0	20,243.0	145
South Kalimantan	2,709.9	4,300.1	640.6	410.5	71.3	12,899.4	166
East Kalimantan	4,223.2	4,121.7	1,815.7	1,165.0	368.3	24,308.5	281
Sulawesi	6,272.9	3,849.9	13,022.9	1,795.8	1,811.1	39,054.4	475
North Sulawesi	326.1	277.8	1,132.4	51.8	58.0	6,062.4	91
Central Sulawesi	2,636.8	725.5	630.7	543.9	11.3	6,389.2	74
South Sulawesi	2,597.5	1,880.0	11,168.7	696.2	1,574.9	22,443.0	268
Southeast Sulawesi	712.5	966.6	91.1	503.9	166.9	4,159.8	42
Nusa Tenggara	244.6	1,222.5	1,288.5	35.2	51.4	5,237.3	131
West Nusa Tenggara	0.7	352.5	638.5	14.9	50.0	2,821.1	78
East Nusa Tenggara	243.9	870.0	650.5	20.3	1.4	2,416.2	53
Bali	561.3	850.7	804.6	1,002.7	34.1	10,979.2	316
East Timor	450.0	-	2,802.6	47.8	-	3,359.4	8
Maluku	282.6	1,060.0	44.5	20.0	-	7,688.7	133
Irian Jaya	6,665.5	1,711.6	1,278.7	8,416.0	-	24,945.9	87
Total	100,715.2	119,872.9	60,749.3	53,550.1	17,496.5	809,639.5	11,091

1) From July 1968 to December 2000, after taking into account cancellation and shifting of projects from foreign to domestic investment

2) at the end of July 2000

Source : Investment Coordination Board (BKPM)

Table 11
Approved Foreign Direct Investment Projects by Sector
(Millions of Dollars)

Sector	1996	1997	1998	1999	2000 ²⁾	Total ¹⁾ 1967 to 2000	
						Value	Project (units)
Agriculture, forestry, and fishery	1,521.5	463.7	998.2	482.4	152.2	8,063.6	380.0
Agriculture	1,306.2	436.6	965.2	412.7	131.9	6,686.6	240.0
Forestry	135.5	–	–	–	5.0	653.1	28.0
Fishery	79.8	27.1	33.0	69.7	15.3	723.9	112.0
Mining	1,696.7	1.6	0.3	14.2	2.2	9,925.3	207.0
Manufacturing	16,072.2	23,017.3	8,388.2	6,929.2	5,179.6	146,967.6	4,376.0
Food	691.4	572.8	342.0	680.9	190.4	7,276.6	352.0
Textile	514.6	372.6	216.9	240.2	286.8	7,730.4	800.0
Wood	101.1	69.7	70.8	113.2	106.0	2,369.2	391.0
Paper	2,907.3	5,353.3	40.8	1,411.8	71.0	24,809.8	130.0
Chemical and pharmaceutical	7,404.6	12,376.4	6,178.8	3,268.2	3,176.0	68,478.9	928.0
Non-metal mineral	789.8	1,457.3	237.1	110.4	8.2	7,068.8	166.0
Basic metal	650.9	357.0	394.4	501.3	794.1	9,786.2	136.0
Metal products	2,938.6	2,331.7	890.5	593.0	544.0	18,801.2	1,337.0
Others	73.9	126.5	16.9	10.2	3.1	646.5	136.0
Construction	296.8	306.8	197.8	153.4	87.8	2,049.0	376.0
Hotel	1,716.5	462.6	451.1	228.6	29.4	11,327.4	331.0
Transportation	694.6	5,900.0	79.0	102.7	138.1	13,529.6	279.0
Real estate and office buildings	3,000.3	1,397.6	1,270.9	171.1	104.6	12,697.6	221.0
Other services	4,932.8	2,282.9	2,177.6	2,800.2	393.1	23,922.4	2,278.0
Total	29,931.4	33,832.5	13,563.1	10,881.8	6,087.0	228,482.5	8,448.0

1) From July 1967 to December 2000, after taking into account cancellation and shifting of projects from foreign to domestic investment

2) at the end of July 2000

Source : Investment Coordination Board (BKPM)

Table 12
Approved Foreign Direct Investment Projects by Province
(Millions of Dollars)

Province	1996	1997	1998	1999	2000 ²⁾	Total ¹⁾ 1967 to 2000	
						Value	Project (units)
Java and Madura	17,908.4	20,535.0	10,840.4	2,635.9	5,576.9	144,536.6	6,345
Jakarta	4,403.9	6,136.1	1,700.1	783.8	627.2	34,897.1	2,754
West Java	7,760.1	7,973.3	5,504.1	1,498.2	1,835.6	64,993.2	2,646
Central Java	3,273.7	2,195.7	3,066.7	69.7	2,989.0	13,837.6	267
Yogyakarta	69.0	14.3	6.0	10.5	1.2	309.9	45
East Java	2,401.7	4,215.6	563.5	273.7	123.9	30,498.8	633
Sumatera	4,297.6	11,163.9	1,415.7	7,652.6	335.5	49,753.1	1,061
Aceh	525.8	771.9	6.2	51.8	0.6	2,549.5	44
North Sumatera	614.7	3,514.6	229.6	102.7	124.8	9,978.0	203
West Sumatera	79.3	7.1	175.8	344.9	14.0	1,036.2	52
Riau	1,664.5	6,743.0	537.1	6,956.9	146.2	24,801.8	607
Jambi	9.0	–	201.9	42.0	34.5	4,407.8	19
South Sumatera	1,292.3	73.2	129.3	39.7	6.5	5,147.4	61
Bengkulu	64.2	–	37.7	18.4	–	258.1	23
Lampung	47.8	54.1	98.1	96.2	8.9	1,574.3	52
Kalimantan	2,876.6	1,056.1	722.7	226.8	54.7	11,513.7	267
West Kalimantan	547.1	28.2	251.2	102.0	–	1,225.6	73
Central Kalimantan	140.2	6.0	0.4	50.3	10.7	547.4	55
South Kalimantan	19.2	438.7	73.4	30.3	3.1	3,279.0	49
East Kalimantan	2,170.1	583.2	397.7	44.2	40.9	6,461.7	90
Sulawesi	2,552.6	426.0	192.7	141.8	42.8	8,916.0	170
North Sulawesi	72.3	358.8	157.4	24.1	3.6	1,117.9	68
Central Sulawesi	10.0	5.5	6.9	2.7	0.3	172.2	21
South Sulawesi	2,467.5	58.3	27.8	12.5	34.6	7,373.8	60
Southeast Sulawesi	2.8	3.5	0.6	102.5	4.3	252.1	21
Nusa Tenggara	1,385.0	14.5	57.2	15.0	5.4	3,936.8	77
West Nusa Tenggara	1,316.2	0.6	34.6	13.6	0.4	3,774.3	59
East Nusa Tenggara	68.8	14.0	22.6	1.4	5.0	162.5	18
Bali	380.0	114.7	308.5	193.8	33.1	3,381.7	441
East Timor	2.8	–	12.4	–	–	45.2	2
Maluku	4.9	17.8	4.9	1.7	0.1	395.5	28
Irian Jaya	523.5	504.4	8.6	23.2	38.5	6,003.9	57
Total	29,931.4	33,832.5	13,563.1	10,890.8	6,087.0	228,482.5	8,448

1) From July 1967 to December 2000, after taking into account cancellation and shifting of projects from foreign to domestic investment

2) at the end of July 2000

Source : Investment Coordination Board (BKPM)

Table 13
Approved Foreign Direct Investment Projects by Country of Origin
(Millions of Dollars)

Country of Origin	1996	1997	1998	1999	2000 ²⁾	Total ¹⁾ 1967 to 2000	
						Value	Project (units)
Europe	5,233.4	11,740.2	5,311.0	730.2	3,250.2	41,250.8	1,254
Netherlands	1,329.5	319.5	411.8	48.7	31.8	6,228.8	267
Belgium	39.5	16.5	11.5	9.8	0.2	367.3	50
United Kingdom	3,390.6	5,473.6	4,745.3	507.0	3,091.4	21,163.5	390
Germany	164.9	4,467.8	71.0	87.1	14.7	8,329.1	192
France	70.8	456.6	7.5	22.7	56.7	1,219.8	107
Switzerland	160.1	73.5	35.1	42.1	34.5	1,083.1	74
Others	78.0	932.7	28.8	12.8	20.9	2,859.2	174
America	754.5	1,112.8	699.6	144.2	100.6	11,642.4	550
United States	642.1	1,017.7	568.3	136.7	92.6	10,449.2	397
Canada	35.8	6.2	8.1	3.2	1.8	156.7	109
Others	76.6	88.9	123.2	4.3	6.2	1,036.5	44
Asia	18,371.3	15,169.6	4,673.8	6,486.1	2,095.0	110,509.6	5,103
Hong Kong	1,105.6	251.0	549.1	76.9	103.5	14,594.4	404
Japan	7,655.3	5,421.3	1,330.7	644.3	1,274.1	36,586.1	1,179
South Korea	1,231.4	1,409.9	202.4	263.0	151.1	9,490.0	936
Malaysia	1,393.3	2,289.3	1,060.2	186.1	119.2	7,035.3	366
Philippines	3.1	–	62.5	4.9	6.1	165.2	26
Singapore	3,131.0	2,298.6	1,267.4	731.1	241.8	19,190.2	1,094
Taiwan	534.6	3,419.4	165.4	1,489.3	35.6	16,100.7	809
Thailand	1,610.6	19.1	2.8	8.4	2.6	1,781.8	38
Others	1,706.4	61.0	33.3	3,082.1	161.0	5,565.9	251
Australia	515.7	187.5	85.1	2,458.5	44.2	9,501.0	456
Africa	5.7	93.5	75.2	65.6	115.5	1,440.1	47
Joint countries	5,050.8	5,528.9	2,718.4	1,006.0	481.5	54,138.6	1,038
Total	29,931.4	33,832.5	13,563.1	10,890.6	6,087.0	228,482.5	8,448

1) From June 1967 to December 2000, after taking into account cancellation and shifting of projects from foreign to domestic investment

2) At the end of July 2000

Source : Investment Coordination Board (BKPM)

Table 14
Consumer Price Index

End of period ¹⁾	Food-stuffs	Prepared food, beverages, cigarettes and tobacco	Housing	Clothing	Medical care	Education, recreation, and sports	Transportation and communication	General Index	Change in General Index (%)
1994 ²⁾	156.97	–	178.57	147.53	161.69	–	–	163.17	9.24
1995	179.14	–	188.93	157.42	173.33	–	–	177.83	8.64
1996	189.99	–	198.00	166.76	190.72	–	–	189.62	6.47
1997	227.88	–	210.36	179.96	206.72	–	–	211.62	11.05
1998									77.63
January-March	166.71	142.23	128.61	161.39	155.88	134.74	119.74	142.15	27.11
April-June ³⁾	196.39	167.92	139.17	195.29	171.97	140.84	150.38	163.89	15.29
July-September	261.00	207.21	155.92	225.22	204.49	162.17	163.18	196.23	19.73
October-December	263.22	211.58	159.03	219.71	212.54	161.84	163.70	198.64	1.23
1999									2.01
January	281.09	213.80	160.62	232.11	214.07	161.40	164.95	204.54	2.97
February	287.60	216.87	162.06	234.23	214.12	161.89	164.29	207.12	1.26
March	281.65	216.34	162.92	234.71	215.80	162.05	169.16	206.75	-0.18
April	275.09	215.52	164.04	233.58	216.57	162.04	169.07	205.34	-0.68
May	271.38	215.20	164.91	231.18	217.60	162.59	170.06	204.76	-0.28
June	268.25	215.16	165.34	228.32	218.22	163.06	170.23	204.07	-0.34
July	258.96	214.87	166.06	224.69	219.48	163.87	169.94	201.93	-1.05
August	248.54	215.33	165.87	226.56	220.98	166.48	169.68	200.05	-0.93
September	239.06	216.26	166.12	229.63	220.00	169.52	169.94	198.68	-0.68
October ⁴⁾	237.24	216.13	166.45	232.23	220.06	170.17	171.31	198.79	0.06
November	240.00	216.51	165.93	228.38	219.97	170.42	171.56	199.00	0.25
December	249.54	219.20	166.77	233.21	220.37	170.44	172.20	202.45	1.73
2000									
January	256.85	220.00	167.56	237.47	220.87	170.43	173.68	205.12	3.26
February	256.00	220.17	168.34	239.79	221.85	170.23	173.45	205.27	0.07
March	250.16	219.97	169.05	240.09	222.43	171.83	174.01	204.34	-0.45
April	246.16	225.28	171.03	240.50	224.87	173.50	176.83	205.48	0.56
May	246.08	225.07	174.18	242.55	225.76	174.91	181.19	207.21	0.84
June	246.47	227.25	174.87	244.54	226.50	175.41	182.54	208.24	0.50
July	251.39	229.45	176.06	248.54	229.42	178.51	183.37	210.91	1.28
August	246.68	231.43	176.71	247.01	230.43	195.70	184.69	211.99	0.51
September	240.76	232.73	177.93	247.12	236.19	198.02	186.65	211.87	-0.06
October	241.37	237.42	180.60	248.68	238.16	199.24	191.19	214.33	1.16
November	246.97	241.62	182.93	249.95	240.47	199.50	191.78	217.15	1.32
December	259.59	243.49	183.61	256.98	241.46	200.28	194.00	222.10	1.94

1) Figures at the end of year/quarter

2) From April 1988 to March 1989 = 100 with 4 categories, column (2) refers to foods; column (6) refers to miscellaneous

3) From January 1996 to December 1996 = 100, CPI was calculated based on survey in 44 cities and commodities were classified into 7 categories

4) Since October 1999, CPI is calculated based on surveys in 43 cities (excl. Dili)

Source : BPS – Statistics Indonesia

Table 15
Wholesale Price Index¹⁾

Group	1996	1997	1998	1999	2000²⁾	Changes 1999-2000 (%)
Agriculture	399	445	750	410	459	11.95
Mining and quarry	296	318	396	214	236	10.28
Manufacturing	265	275	455	268	278	3.73
Imports	243	260	598	289	316	9.34
Exports	203	238	592	366	461	25.96
Oil and gas	173	204	474	355	393	10.70
Non-oil and gas	306	353	994	370	634	71.35
General index	258	282	568	314	353	12.42

1) From 1996 to 1998 using constant 1983 market price (1983=100)
From 1999 to 2000 using constant 1993 market price (1993=100)
Annual figure is average number over the year

2) Up to October 2000

Source : BPS – Statistics Indonesia

Table 16
Inflation Rates in 43 cities
(%)

City	1996	1997	1998 ¹⁾	1999 ²⁾	2000
Lhokseumawe	-	-	79.66	6.61	8.73
Banda Aceh	6.66	9.90	79.01	5.57	10.57
Padang Sidempuan	-	-	85.72	-0.14	3.95
Sibolga	-	-	85.01	1.65	6.95
Pematang Siantar	-	-	80.23	-0.54	4.67
Medan	8.70	13.10	83.81	1.68	5.90
Padang	7.32	10.72	87.20	4.23	10.99
Pekanbaru	4.32	11.05	75.86	4.35	10.34
Batam	-	-	52.89	-0.28	9.00
Jambi	5.00	9.89	72.31	0.49	8.40
Palembang	6.14	13.58	89.18	-1.01	8.49
Bengkulu	5.18	9.21	84.10	0.47	8.21
Bandar Lampung	6.09	9.70	85.22	3.34	10.18
Jakarta	7.25	11.70	74.42	1.77	10.29
Tasikmalaya	-	-	73.55	1.58	4.57
Serang/Cilegon	-	-	65.43	-0.04	7.03
Bandung	6.54	9.95	72.59	4.29	8.52
Cirebon	-	-	62.23	4.75	6.52
Purwokerto	-	-	80.93	0.99	10.02
Surakarta	-	-	66.38	0.46	7.89
Semarang	4.37	10.88	67.19	1.51	8.73
Tegal	-	-	67.73	1.11	7.85
Yogyakarta	3.05	12.72	77.46	2.51	7.32
Jember	-	-	84.95	3.16	10.35
Kediri	-	-	77.08	-0.64	7.05
Malang	-	-	93.16	1.49	10.62
Surabaya	6.68	9.11	95.21	0.24	10.46
Denpasar	3.14	9.75	75.11	4.39	9.81
Mataram	6.33	8.66	90.50	0.59	5.19
Kupang	5.04	7.71	62.58	10.65	10.62
Dili	7.30	9.79	72.36	5.86 ³⁾	-
Pontianak	5.75	12.29	78.85	4.49	8.34
Sampit	-	-	75.94	-4.98	11.87
Palangkaraya	3.22	13.03	74.65	-0.13	8.57
Banjarmasin	5.71	12.98	74.43	1.47	7.57
Balikpapan	-	-	75.10	3.01	10.67
Samarinda	4.05	10.93	68.31	3.69	11.91
Manado	3.98	13.66	74.24	7.41	11.41
Palu	6.33	9.70	95.18	3.58	8.11
Makasar	4.56	8.20	80.86	1.64	9.73
Kendari	5.16	8.42	97.79	1.29	11.25
Ternate	-	-	72.98	0.38	14.51
Ambon	6.12	7.99	75.82	8.26	8.52
Jayapura	6.78	10.35	61.83	3.49	10.23
National Inflation	6.47	11.05	77.63	2.01	9.35

1) 1996 = 100, calculated based on survey in 44 cities and classified into 7 categories

2) 1996 = 100, calculated based on survey in 43 cities (excl. Dili) and classified into 7 categories

3) Up to September 1999

Source : BPS - Statistics Indonesia

Table 17
Balance of Payments ¹⁾
(Millions of Dollars)

Item	1997	1998	1999	2000*
A. Balance on goods and services	-5,001	3,589	4,978	7,068
1. Merchandise : exports f.o.b.	56,297	50,371	51,242	62,510
imports f.o.b.	-46,223	-31,942	-30,598	-37,423
2. Freight and insurance on imports	-5,084	-3,337	-2,719	-3,050
3. Other transportation	-934	-852	-955	-1,116
4. Travel	4,236	2,154	2,000	1,568
5. Investment services	-8,946	-9,955	-11,029	-12,144
5.1. Oil and LNG sector	-2,614	-1,766	-2,033	-3,224
5.2. Direct investment and others	-6,332	-8,189	-8,997	-8,920
6. Government, not included elsewhere	-244	-78	-91	-110
7. Other services	-4,103	-2,773	-2,872	-3,166
Trade Balance (1)	10,074	18,429	20,644	25,087
Balance on services (2 through 7)	-15,075	-14,841	-15,666	-18,019
B. Grants	309	508	805	626
8. Private	-□	-□	--	--
9. Government	309	508	804	626
C. Current account (A + B)	-4,692	4,097	5,783	7,694
D. Capital movements	6,343	-6,219	-7,863	-9,625
D.1. Other than reserves	2,233	-3,875	-4,571	-4,638
10. Direct investment and other long-term capital movements	4,478	4,354	139	531
10.1. Direct investment	4,677	-356	-2,745	-4,056
10.2. Bonds	--	--	--	--
a. Official	--	--	--	--
b. Private	-□	-□	-□	--
10.3. Other long-term capital movements	-199	2,931	2,884	4,587
a. Official	2,571	9,970	5,352	3,830
b. Private	-2,770	-7,039	-2,468	757
11. Short-term capital movements	-2,245	-6,450	-4,710	-5,169
11.1. Official	0	0	0	0
11.2. Private	-2,245	-6,450 ²⁾	-4,710	-5,169
D.2. Reserves	4,110	-2,344	-3,292	-4,987
12. Monetary gold	219	6	-9	53
13. Special Drawing Rights	-524	132	156	206
14. Reserves position in the Fund	273	0	0	-190
15. Foreign exchange	4,142	-2,482	-3,439	-5,056
16. Others	0	0	0	0
E. Errors and Omissions (between C and D)	-1,651	2,122	2,080	1,931

- 1) – Presentation follows the IMF standard
– Positive sign means deficit and negative sign means surplus
– Before 1998, using Official Reserves concept
– Since 2000, using International Reserves and Foreign Currency Liquidity (IRFCL)
2) Revised

Table 18
Export Value of Non-oil and gas by Commodity
(Millions of Dollars)

Item	1996	1997	1998	1999	2000 ¹⁾
Total Exports	38,021	44,577	42,951	40,987	47,045
Agriculture	5,166	5,166	5,091	4,179	4,237
Wood	58	64	53	86	92
Rubber	1,894	1,505	1,006	854	899
Coffe	598	583	602	465	334
Tea	106	152	169	102	108
Pepper	99	165	195	183	229
Tobacco	82	124	139	108	84
Tapioca	49	23	21	23	11
Animal and animal products	1,682	1,789	1,779	1,574	1,555
– Shrimps	994	1,047	1,041	886	938
Skins	33	56	72	74	89
Others	566	706	1,056	710	835
Mining	3,640	4,353	4,703	4,130	5,174
Tin	310	277	260	242	243
Copper	1,397	1,548	1,792	1,441	2,124
Nickel	374	233	165	219	412
Aluminum	320	280	202	138	274
Coal	1,058	1,638	1,669	1,665	1,619
Others	182	377	614	425	502
Manufacturing	29,215	35,057	33,157	32,678	37,634
Textiles and textile products	5,869	7,614	7,034	6,291	6,693
– Garments	3,187	4,186	3,769	3,450	3,702
Handicrafts	526	1,031	2,089	569	515
Wood and wood products	5,378	5,704	4,245	4,526	4,239
– Plywood	3,544	3,482	2,328	2,259	1,936
Rattan products	324	204	39	255	285
Palm Oil	1,017	1,662	888	1,369	1,199
Copra oil-cake	106	86	51	47	50
Chemical products	1,241	1,746	2,098	1,835	2,065
Metal products	953	1,140	1,387	1,078	1,111
Electrical appliances	3,593	3,264	2,813	3,365	5,746
Cement	18	37	87	143	138
Paper	1,369	1,957	2,471	2,645	3,017
Rubber products	336	406	415	374	405
Glass and glassware	211	272	269	279	337
Footwear	2,049	2,219	1,583	1,519	1,575
Plastics products	590	787	935	860	1,099
Machinery and mechanical	1,108	1,415	1,478	1,853	3,287
Others	4,527	5,515	5,275	5,670	5,874

1) Projection figures

Table 19
Export Volume of Non-oil and gas by Commodity
(Thousands of Tonnes)

Item	1996		1997		1998		1999		2000 ¹⁾	
	Volume	Share (%)	Volume	Share (%)	Volume	Share (%)	Volume	Share (%)	Volume	Share (%)
Total Exports	138,260	100.0	251,845	100.0	199,771	100.0	175,610	100.0	153,916	100.0
Agriculture	4,757	3.4	4,731	1.9	5,936	3.0	5,395	3.1	4,321	2.8
Wood	643	0.5	708	0.3	489	0.2	679	0.4	650	0.4
Rubber	1,498	1.1	1,483	0.6	1,584	0.8	1,544	0.9	1,392	0.9
Coffee	372	0.3	356	0.1	411	0.2	362	0.2	360	0.2
Tea	98	0.1	96	0.0	113	0.1	107	0.1	104	0.1
Pepper	39	0.0	33	0.0	45	0.0	35	0.0	61	0.0
Tobacco	30	0.0	56	0.0	114	0.1	78	0.0	32	0.0
Tapioca	410	0.3	244	0.1	211	0.1	300	0.2	152	0.1
Animal and animal products	606	0.4	704	0.3	949	0.5	819	0.5	600	0.4
– Shrimps	134	0.1	141	0.1	165	0.1	164	0.1	133	0.1
Skins	0	0.0	1	0.0	13	0.0	38	0.0	10	0.0
Others	1,061	0.8	1,050	0.4	2,007	1.0	1,433	0.8	958	0.6
Mining	110,181	79.7	217,018	86.2	154,226	77.2	116,809	66.5	108,969	70.8
Tin	56	0.0	50	0.0	49	0.0	47	0.0	49	0.0
Copper	1,606	1.2	1,932	0.8	2,946	1.5	2,261	1.3	2,849	1.9
Nickel	1,952	1.4	2,224	0.9	1,409	0.7	2,008	1.1	2,085	1.4
Aluminum	690	0.5	1,081	0.4	1,076	0.5	1,125	0.6	1,375	0.9
Coal	29,842	21.6	45,822	18.2	52,411	26.2	53,899	30.7	59,549	38.7
Others	76,035	55.0	165,909	65.9	96,335	48.2	57,469	32.7	43,063	28.0
Manufacturing	23,322	16.9	30,096	12.0	39,609	19.8	49,307	28.1	40,637	26.4
Textiles and textile products	967	0.7	1,369	0.5	1,635	0.8	1,525	0.9	1,531	1.0
– Garments	259	0.2	318	0.1	414	0.2	333	0.2	315	0.2
Handicrafts	124	0.1	183	0.1	223	0.1	196	0.1	192	0.1
Wood and wood products	6,748	4.9	6,914	2.7	7,302	3.7	6,791	3.9	6,322	4.1
– Plywood	5,147	3.7	5,087	2.0	5,157	2.6	4,302	2.4	3,795	2.5
Rattan products	92	0.1	52	0.0	14	0.0	114	0.1	124	0.1
Palm Oil	1,873	1.4	3,245	1.3	1,700	0.9	3,600	2.0	3,912	2.5
Copra oil-cake	976	0.7	1,090	0.4	984	0.5	983	0.6	1,078	0.7
Chemical products	2,559	1.9	4,206	1.7	6,883	3.4	5,378	3.1	5,213	3.4
Metal products	902	0.7	1,090	0.4	3,391	1.7	3,191	1.8	1,456	0.9
Electrical appliances	317	0.2	356	0.1	381	0.2	437	0.2	628	0.4
Cement	303	0.2	794	0.3	3,736	1.9	7,383	4.2	7,356	4.8
Paper	2,427	1.8	3,768	1.5	5,585	2.8	9,048	5.2	4,932	3.2
Rubber products	134	0.1	167	0.1	203	0.1	209	0.1	211	0.1
Glass and glassware	597	0.4	643	0.3	957	0.5	1,555	0.9	940	0.6
Footwear	199	0.1	193	0.1	173	0.1	165	0.1	153	0.1
Plastics products	481	0.3	720	0.3	1,244	0.6	1,045	0.6	1,090	0.7
Machinery and mechanical	83	0.1	114	0.0	763	0.4	166	0.1	258	0.2
Others	4,540	3.3	5,192	2.1	4,435	2.2	7,156	4.1	5,241	3.4

1) Projection figures

Table 20
Export Value of Non-oil and gas by Country of Destination
(Millions of Dollars)

Continent/country	1996		1997		1998		1999		2000 ¹⁾	
	Value	Share (%)	Value	Share (%)	Value	Share (%)	Value	Share (%)	Value	Share (%)
Africa	622	1.6	777	1.7	904	2.1	1,032	2.5	1,049	2.2
America	7,585	19.9	8,286	18.6	7,815	18.2	7,679	18.7	9,504	20.2
United States	6,259	16.5	6,701	15.0	6,383	14.9	6,297	15.4	8,055	17.1
Latin America	742	2.0	875	2.0	459	1.1	429	1.0	590	1.3
Canada	365	1.0	397	0.9	409	1.0	346	0.8	405	0.9
Others	219	0.6	314	0.7	564	1.3	607	1.5	454	1.0
Asia	21,553	56.7	25,350	56.9	24,831	57.8	23,573	57.5	26,501	56.3
ASEAN	5,970	15.7	7,723	17.3	8,723	20.3	7,982	19.5	9,110	19.4
Brunei Darussalam	29	0.1	47	0.1	43	0.1	26	0.1	22	0.0
Malaysia	1,061	2.8	1,343	3.0	1,358	3.2	1,388	3.4	1,747	3.7
Philippines	535	1.4	734	1.6	608	1.4	646	1.6	793	1.7
Singapore	3,714	9.8	4,913	11.0	5,798	13.5	4,998	12.2	5,683	12.1
Thailand	630	1.7	686	1.5	916	2.1	923	2.3	865	1.8
Hong Kong	1,568	4.1	2,053	4.6	2,037	4.7	1,400	3.4	1,463	3.1
India	448	1.2	597	1.3	782	1.8	807	2.0	1,005	2.1
Iraq	1	0.0	19	0.0	45	0.1	63	0.2	87	0.2
Japan	7,129	18.7	7,015	15.7	5,964	13.9	5,791	14.1	7,092	15.1
South Korea	1,348	3.5	1,297	2.9	1,166	2.7	1,287	3.1	1,587	3.4
Myanmar	80	0.2	159	0.4	175	0.4	101	0.2	66	0.1
Pakistan	124	0.3	170	0.4	152	0.4	151	0.4	143	0.3
People's Republic of China	965	2.5	1,387	3.1	1,320	3.1	1,486	3.6	1,746	3.7
Saudi Arabia	505	1.3	627	1.4	476	1.1	428	1.0	505	1.1
Taiwan	1,056	2.8	1,330	3.0	1,288	3.0	1,234	3.0	1,381	2.9
Others	2,357	6.2	2,975	6.7	2,702	6.3	2,846	6.9	2,318	4.9
Australia and Oceania	591	1.6	783	1.8	910	2.1	1,058	2.6	1,030	2.2
Europe	7,671	20.2	9,379	21.0	8,491	19.8	7,645	18.7	8,961	19.0
European Community	6,795	17.9	8,408	18.9	7,474	17.4	6,744	16.5	8,311	17.7
Netherlands	1,555	4.1	1,825	4.1	1,488	3.5	1,464	3.6	1,776	3.8
Belgium and Luxembourg	620	1.6	804	1.8	773	1.8	687	1.7	855	1.8
United Kingdom	1,138	3.0	1,263	2.8	1,120	2.6	1,175	2.9	1,487	3.2
Italy	558	1.5	636	1.4	729	1.7	605	1.5	674	1.4
Germany	1,415	3.7	1,502	3.4	1,458	3.4	1,217	3.0	1,356	2.9
France	541	1.4	527	1.2	545	1.3	506	1.2	666	1.4
Others	968	2.5	1,851	4.2	1,360	3.2	1,090	2.7	1,496	3.2
Former Soviet Union	129	0.3	120	0.3	67	0.2	49	0.1	77	0.2
Other Eastern Europe	224	0.6	196	0.4	310	0.7	232	0.6	205	0.4
Others	522	1.4	656	1.5	640	1.5	621	1.5	368	0.8
Total	38,021	100.0	44,576	100.0	42,951	100.0	40,987	100.0	47,045	100.0

1) Projection figures

Table 21
Import Value of Non-oil and gas by Country of Origin (FOB)
(Millions of Dollars)

Continent/country	1996		1997		1998		1999		2000 ¹⁾	
	Value	Share (%)	Value	Share (%)	Value	Share (%)	Value	Share (%)	Value	Share (%)
Africa	372	0.9	422	1.0	362	1.2	449	1.7	452	1.4
America	7,103	17.8	7,374	17.8	5,285	18.2	4,973	18.7	5,363	16.7
United States	4,280	10.7	4,765	11.5	3,150	10.8	2,541	9.5	3,847	12.0
Latin America	818	2.1	733	1.8	420	1.4	507	1.9	661	2.1
Canada	724	1.8	609	1.3	422	1.5	360	1.4	719	2.2
Others	1,281	3.2	1,267	3.1	1,294	4.4	1,566	5.9	135	0.4
Asia	19,941	50.0	20,495	49.4	14,354	49.3	13,810	51.9	18,061	56.3
ASEAN	2,940	7.4	3,494	8.4	2,396	8.2	2,730	10.2	4,474	13.9
Brunei Darussalam	2	0.0	4	0.0	2	0.0	1	0.0	2	0.0
Malaysia	562	1.4	619	1.5	344	1.2	424	1.6	766	2.4
Philippines	78	0.2	108	0.3	71	0.2	48	0.2	133	0.4
Singapore	1,319	3.3	1,788	4.3	1,195	4.1	1,433	5.4	2,366	7.4
Thailand	979	2.5	974	2.3	785	2.7	824	3.1	1,207	3.8
Hong Kong	215	0.5	269	0.6	236	0.8	212	0.8	433	1.3
India	752	1.9	630	1.5	256	0.9	231	0.9	551	1.7
Iraq	1	0.0	3	0.0	3	0.0	0	0.0	1	0.0
Japan	7,375	18.5	7,517	18.1	4,202	14.4	2,541	9.5	5,928	18.5
South Korea	2,009	5.0	1,973	4.8	1,228	4.2	1,064	4.0	2,102	6.5
Myanmar	33	0.1	19	0	10	0.0	17	0.1	24	0.1
Pakistan	110	0.3	42	0.1	128	0.4	98	0.4	61	0.2
People's Republic of China	1,137	2.9	1,167	2.8	887	3.0	1,039	3.9	2,069	6.4
Saudi Arabia	217	0.5	115	0.3	105	0.4	120	0.5	297	0.9
Taiwan	1,406	3.5	1,360	3.3	882	3.0	695	2.6	1,507	4.7
Others	3,745	9.4	3,907	9.4	4,022	13.8	5,062	19.0	614	1.9
Australia and Oceania	2,112	5.3	2,181	5.3	1,614	5.5	2,021	7.6	2,175	6.8
Europe	10,342	25.9	10,974	26.5	7,472	25.7	5,378	20.2	6,049	18.8
European Community	6,846	17.2	7,686	18.5	4,938	17.0	3,027	11.4	4,553	14.2
Netherlands	434	1.1	474	1.1	316	1.1	314	1.2	525	1.6
Belgium and Luxembourg	331	0.8	292	0.7	232	0.8	143	0.5	365	1.1
United Kingdom	960	2.4	1,082	2.6	779	2.7	500	1.9	784	2.4
Italy	1,076	2.7	931	2.2	476	1.6	232	0.9	394	1.2
Germany	2,624	6.6	2,410	5.8	2,399	8.2	1,232	4.6	1,446	4.5
France	859	2.2	1,929	4.7	513	1.8	328	1.2	597	1.9
Others	562	1.4	570	1.4	224	0.8	277	1.0	441	1.4
Former Soviet Union	272	0.7	312	0.8	151	0.5	102	0.4	282	0.9
Other Eastern Europe ²⁾	129	0.3	124	0.3	68	0.2	44	0.2	58	0.2
Others	129	7.8	2,853	6.9	2,316	8.0	2,204	8.3	1,155	3.6
Total	39,870	100.0	41,447	100.0	29,087	100.0	26,632	100.0	32,099	100.0

1) Projection figures

2) Consists of Czech Republic, Slovak Republic, East Germany, Hungary, Poland, Romania, Bulgaria, and former Yugoslavia

**Table 22
Exports of Oil and Gas¹⁾**

Description	1996	1997	1998	1999	2000
Export Value ²⁾					
Oil ³⁾	7,222	6,771	4,141	5,680	8,631
Gas					
– LNG	4,400	4,432	3,046	4,207	6,426
– LPG	545	518	233	369	409
Total	12,167	11,721	7,420	10,256	15,466
Export Volume					
Oil (millions of barrels)	362	362	340	336	307
Gas					
– LNG (millions of MMBTU) ⁴⁾	1,357	1,387	1,384	1,511	1,406
– LPG (millions of MT) ⁵⁾	2,672	2,233	1,620	1,865	1,362

1) The items classification of f.o.b value changed into HS (Harmonized Commodity Description and Coding System) so that groups of exports items changed

2) Millions of dollars

3) Consists of crude oil and oil products

4) MMBTU : Million British Thermal Unit

5) MT : Metric Tonnes

Table 23
Money Supply
(Billions of Rupiah)

End of period	M1 ¹⁾		Quasi money ²⁾		M2 ³⁾		
	Outstanding	Share	Outstanding	Share	Outstanding	Change (%)	
		(%)		(%)		Annual	Quarterly
1996	64,089	22.2	224,543	77.8	288,632	29.6	11.0
1996/97	63,565	21.6	231,016	78.4	294,581	26.7	2.1
1997	78,343	22.0	277,300	78.0	355,643	23.2	8.1
1997/98	98,270	21.8	351,554	78.2	449,824	52.7	26.5
1998r	101,197	17.5	476,184	82.5	577,381	62.3	4.9
1998/1999	105,705	17.5	497,620	82.5	603,325	34.1	4.5
1999							
March ⁴⁾	105,705	17.5	497,620	82.5	603,325	34.1	4.5
June	105,964	17.2	509,447	82.8	615,411	8.8	2.0
September	118,124	18.1	534,165	81.9	652,289	18.5	6.0
December	124,633	19.3	521,572	80.7	646,205	11.9	-0.9
2000							
January	122,417	18.8	528,180	81.2	650,597	9.1	
February	122,160	18.7	531,174	81.3	653,334	8.4	
March	124,663	19.0	531,788	81.0	656,451	8.8	1.6
April	127,367	19.1	538,284	80.9	665,651	8.6	
May	130,225	19.1	553,252	80.9	683,477	8.8	
June	133,832	19.6	550,503	80.4	684,335	11.2	4.2
July	135,739	19.7	554,196	80.3	689,935	10.0	
August	136,530	19.9	549,072	80.1	685,602	7.7	
September	135,431	19.7	551,024	80.3	686,455	5.2	0.3
October	138,885	19.6	568,562	80.4	707,447	12.5	
November	141,204	19.6	579,058	80.4	720,262	12.7	
December	162,185	21.7	584,842	78.3	747,027	15.6	8.8

1) Consisting of currency and demand deposits

2) Consisting of time and saving deposits in rupiah and foreign currency, and demand deposits in foreign currency held by residents

3) Consisting of narrow money (M1) and quasi money

4) Excluding data from frozen banks in April 1998 (7 banks), August 1998 (3 banks), dan March 1999 (38 banks)

Table 24
Changes in Money Supply and its Affecting Factors
(Billions of Rupiah)

Item	1996	1997	1998r	1999r	2000	2000			
						I	II	III	IV
Money Supply									
M2	65,994	67,011	221,738	68,824	100,822	10,246	27,884	2,120	60,572
M1	11,412	14,254	22,854	23,436	37,552	30	9,169	1,599	26,754
Currency	1,680	5,755	12,970	16,959	14,017	-7,156	4,634	1,013	15,526
Demand deposits	9,732	8,317	9,884	6,477	23,535	7,186	4,535	586	11,228
Quasi money ¹⁾	54,582	52,757	198,884	45,388	63,270	10,216	18,715	521	33,818
Affecting Factors :									
Net foreign assets	18,015	17,344	73,692	-12,580	81,636	8,846	43,961	-4,247	33,076
Net claims on central government	-2,757	-16,486	17,513	425,287	123,060	61,903	38,509	23,893	-1,245
Net claims on IBRA	0	0	29,693	-29,693	0	0	0	0	0
Claims on business sector	56,394	137,062	99,421	-299,689	42,347	1,591	14,973	89	25,694
Claims on official entities/ state enterprises	4,626	5,031	6,389	-8,139	-4,506	-3,192	3,541	-257	-4,598
Claims on private enterprises and individuals	51,768	132,031	93,032	-291,550	46,852	4,784	11,431	346	30,291
Net other items	-5,658	-70,909	31,112	-44,194	-146,221	-62,094	-69,559	-17,615	3,047

1) Consisting of time and saving deposits in rupiah and foreign currency, and demand deposits in foreign currency held by residents

Table 25
Interest Rates on Time Deposits by Denomination and Group of Banks ¹⁾
(Percent per annum)

Maturity	December 1996		December 1997		December 1998		December 1999		December 2000	
	Rupiah	Foreign Currency	Rupiah	Foreign Currency	Rupiah	Foreign Currency	Rupiah	Foreign Currency	Rupiah	Foreign Currency
State banks										
1 month	14.40	5.67	19.74	7.31	41.24	13.23	12.52	5.44	12.05	6.37
3 month	14.58	6.32	19.88	7.41	48.69	13.70	13.19	5.45	13.33	6.59
6 month	16.14	6.76	15.66	7.49	35.17	8.14	14.44	7.94	13.42	6.17
12 month	16.05	7.23	15.19	7.81	28.75	12.61	23.14	8.91	12.48	6.24
24 month	14.50	7.79	15.32	7.23	16.01	14.87	18.53	14.87	14.32	10.23
Private national banks										
1 month	16.96	6.86	27.68	8.77	41.88	12.72	12.14	5.34	12.05	6.07
3 month	17.56	6.85	27.76	8.40	50.24	10.64	12.66	5.68	13.20	6.43
6 month	17.42	7.73	19.17	7.81	33.34	10.21	13.55	7.98	13.16	6.23
12 month	17.26	8.01	17.43	7.99	26.16	11.49	17.07	16.63	11.50	11.39
24 month	17.26	6.88	16.79	7.76	22.85	14.91	17.59	8.02	14.22	8.14
Regional government banks										
1 month	14.93	6.73	21.10	6.23	42.05	12.99	12.20	5.09	11.39	4.97
3 month	15.64	6.73	20.62	6.76	45.35	10.99	12.51	6.19	12.92	4.56
6 month	15.01	7.48	14.16	7.15	29.46	10.43	13.46	5.18	12.94	5.13
12 month	16.27	7.36	16.65	7.20	23.91	12.94	16.17	5.67	11.43	5.05
24 month	15.24	-	14.58	-	14.03	-	13.73	-	13.44	-
Foreign banks and joint banks										
1 month	13.53	4.95	17.70	5.19	33.07	4.71	9.46	4.08	9.73	4.61
3 month	13.77	5.14	18.03	5.99	40.84	4.71	9.24	4.03	11.21	4.81
6 month	15.60	5.05	13.99	5.71	44.42	5.15	9.05	4.31	8.13	4.12
12 month	15.95	5.36	13.64	5.92	31.74	5.17	13.46	4.67	8.51	5.09
24 month	16.58	7.03	15.48	3.57	15.57	3.59	11.67	4.00	13.00	6.05
Commercial banks										
1 month	16.43	6.50	25.39	7.97	41.42	12.11	12.24	5.15	11.96	5.94
3 month	17.03	6.67	23.92	7.77	49.23	10.73	12.95	5.24	13.24	6.11
6 month	16.78	7.17	16.96	7.53	36.78	8.22	14.25	7.85	13.31	5.72
12 month	16.70	7.50	15.92	7.73	28.29	11.66	22.35	9.11	12.17	7.86
24 month	15.14	7.17	15.46	6.47	16.61	14.71	18.38	14.63	14.32	9.47

1) Weighted average at the end of period

Table 26
Inter-bank Money Market in Jakarta

End of period	Value of transaction (billions of rupiah)	Weighted average interest rate (percent per annum)
1996 January – December	477,564	13.96
1997 January – December	784,368	26.98
1998 January – December	2,104,924	64.08
1996 January – March	62,559	12.83
April – June	123,832	14.61
July – September	148,358	14.75
October – December	142,815	13.63
1997 January – March	138,121	12.08
April – June	157,529	13.45
July – September	210,670	42.70
October – December	278,048	39.68
1998 January – March	526,347	57.36
April – June	500,713	66.38
July – September	625,331	74.13
October – December	452,533	54.68
1999		
January – March	173,045	39.57
April – June	160,470	29.70
July – September	127,906	13.44
October – December	133,941	12.43
2000 ¹⁾		
January	1,314	9.19
February	1,978	9.56
March	1,843	9.75
January – March	1,712	9.50
April	1,665	9.64
May	1,957	9.83
June	2,099	10.63
April – June	1,907	10.03
July	1,879	10.90
August	2,626	10.90
September	2,953	10.88
July – September	2,486	10.89
October	2,991	10.87
November	2,502	11.22
December	2,936	12.20
October – December	2,810	11.43

1) Daily average figure

Table 27
Discount Rates on Rupiah Certificates of Deposits by Group of Banks¹⁾
(Percent per annum)

Maturity	1997	1998		1999	2000			
	March	March	December	December	March	June	September	December
State Banks								
1 month	9.14	18.05	43.95	37.96	10.59	10.23	11.48	12.04
3 month	14.98	23.71	55.30	36.94	11.81	10.67	11.86	12.95
6 month	13.69	23.42	32.18	28.13	11.56	11.51	11.55	11.62
12 month	15.59	14.21	23.86	23.60	15.36	13.93	11.68	11.66
24 month	13.79	14.01	12.90	14.22	–	–	–	11.50
Private national banks								
1 month	16.08	29.41	44.26	38.77	11.34	11.20	12.29	12.59
3 month	16.43	30.29	48.62	39.53	11.36	11.09	11.51	11.81
6 month	16.35	22.11	38.35	32.62	10.28	11.74	12.13	13.24
12 month	15.74	15.63	49.89	52.40	16.02	10.44	10.40	12.12
24 month	17.52	17.47	15.93	30.00	–	–	–	–
Regional government banks								
1 month	13.97	22.49	40.49	31.90	11.52	10.33	12.32	11.26
3 month	16.98	20.85	52.57	35.48	12.62	12.10	13.40	13.88
6 month	14.85	15.71	22.00	26.26	12.00	12.00	12.00	12.00
12 month	18.09	18.04	21.20	25.21	12.50	12.10	12.08	13.81
24 month	–	13.86	14.50	14.50	–	–	–	–
Foreign banks and joint banks								
1 month	14.00	13.02	58.46	48.41	–	–	9.07	9.43
3 month	12.00	20.41	39.91	34.00	9.54	10.25	9.26	9.70
6 month	13.23	19.08	–	35.50	–	–	7.98	8.28
12 month	12.85	–	–	–	12.00	12.00	7.98	7.90
24 month	–	–	–	–	–	–	–	–
Commercial Bank								
1 month	14.72	28.80	45.94	39.57	11.31	11.15	12.13	12.47
3 month	16.34	27.56	49.99	38.68	11.31	11.07	11.49	11.83
6 month	15.81	22.40	35.50	30.89	10.87	11.68	11.91	12.00
12 month	15.68	15.58	41.51	28.77	14.41	12.41	10.97	12.11
24 month	15.29	16.95	14.56	14.53	–	–	–	11.50

1) Weighted average at the end of period

Table 28
Issuance, Repayment, and Outstanding of Bank Indonesia Certificates (SBIs)
 (Billions of Rupiah)

Period	Issuance	Repayment	Outstanding ¹⁾
January–December 1996	157,948	151,250	18,553
January–December 1997	176,452	187,969	7,034
January–December 1998	735,844	700,182	42,765
January–December 1999	711,542	691,408	62,899
2000			
January	70,066	51,049	82,066
February	73,289	66,655	88,700
March	94,621	95,451	87,870
April	81,000	79,490	94,380
May	78,024	78,524	93,880
June	79,525	94,278	79,127
July	69,324	68,080	80,371
August	99,654	96,515	83,510
September	65,213	70,847	77,875
October	85,422	83,720	79,578
November	95,524	97,660	77,442
December	37,282	54,943	59,781

Note :

SBI was introduced in February 1984. Since July 1988, the selling of SBIs was executed by Stop Out Rate (SOR) system auction

1) End of month outstanding.

Table 29
Discount Rates on Bank Indonesia Certificates (SBIs)¹⁾
(Percent per annum)

Period	7 day	14 day	28 day	90 day	180 day	360 day
1996						
March	12.86	13.16	13.98	-	-	-
June	12.75	13.13	13.75	-	-	-
September	12.75	13.00	13.75	-	-	-
December	11.72	11.94	12.88	13.75	13.90	14.17
1997						
March	7.61	8.70	11.07	11.88	-	-
June	7.29	8.50	10.50	11.25	12.0	12.50
September	18.35	20.06	22.00	-	-	-
December	16.00	18.00	20.00	-	-	-
1998						
March	29.24	-	27.75	-	-	-
June	-	52.81	58.00	-	-	-
September	-	-	68.76	-	-	-
December	-	-	38.44	39.00	-	-
1999						
March	-	-	37.84	38.00	-	-
June	-	-	22.05	23.75	-	-
September	-	-	13.02	13.25	-	-
December	-	-	12.51	12.75	-	-
2000						
January	-	-	11.48	11.50	-	-
February	-	-	11.13	11.13	-	-
March	-	-	11.03	11.00	-	-
April	-	-	11.00	11.00	-	-
May	-	-	11.08	11.00	-	-
June	-	-	11.74	11.09	-	-
July	-	-	13.53	13.04	-	-
August	-	-	13.53	13.29	-	-
September	-	-	13.62	13.32	-	-
October	-	-	13.74	13.56	-	-
November	-	-	14.15	13.83	-	-
December	-	-	14.53	14.31	-	-

1) Weighted average

Table 30
Money Market Securities (SBPUs) Transactions between Bank Indonesia and Banks
 (Billions of Rupiah)

Period	Buying	Selling	Outstanding
1996			
January–March	21,364	22,988	2,580
April–June	54,044	55,407	1,218
July–September	20,511	20,390	1,339
October–December	25,605	26,773	171
1997			
January–March	15,954	13,455	2,670
April–June	18,937	19,480	2,126
July–September	50,131	52,237	21
October–December	94,934	91,499	3,455
1998			
January–March	257,109	256,474	4,090
April–June	42,929	46,873	146
July–September	24,136	24,057	227
October–December	1,342	550	1,018
1999			
January–March	1,018	1,018	1,018
April–June	0	0	1,018
July–September	0	0	1,018
October–December	644	1,662	0
2000			
January	0	0	0
February	0	0	0
March	0	0	0
April	0	0	0
May	0	0	0
June	0	0	0
July	0	0	0
August	0	0	0
September	0	0	0
October	0	0	0
November	0	0	0
December	0	0	0

Table 31
Government Revenues
(Billions of Rupiah)

Description	1996/97p	1997/98p	1998/99p	1999/00*	2000		2001 Budget
					Budget 1)	Realization 2)	
Revenues from oil & gas and non-oil & gas	87,630	112,276	158,042	205,043	178,297	212,835	296,727
Oil and gas revenues	20,137	30,559	41,368	58,482	33,320	59,618	59,738
Oil ³⁾	14,783	22,264	25,957	38,024	25,311	44,892	45,945
Gas ⁴⁾	5,354	8,295	15,411	20,458	7,918	14,726	13,793
Non-oil and gas revenues	67,493	81,717	116,674	146,561	145,067	153,216	236,989
Income tax	27,062	34,388	55,944	59,683	54,225	57,615	96,287
a. Oil and gas					10,036	17,471	20,837
b. Non-oil and gas					44,189	40,144	75,450
Value-added tax on goods and services and sales tax on luxury goods	20,351	25,199	27,803	33,087	27,002	31,525	48,853
Import duties	2,579	2,999	2,306	4,177	4,976	6,116	9,975
Excise duties	4,263	5,101	7,733	10,381	10,272	10,632	17,100
Export tax	81	129	4,630	848	923	338	397
Land and building tax	2,413	2,641	3,565	4,071	2,901	3,824	5,642
Other taxes	591	478	413	568	1,139	1,014	1,638
Non-tax and net profit on oil sales ⁵⁾	10,153	10,782	14,280	33,746	43,630	42,152	57,097
Net other revenues⁶⁾	-	-	-	-	-	-	-
Total Domestic Revenues	87,630	112,276	158,042	205,043	178,297	212,834	296,727
Grants	-	-	62	51	-	-	-
Notes :							
Privatization	-	-	1,634	3,727	6,500	-	6,500
Asset recovery	-	-	-	12,886	18,900	18,900	27,000

p) Audited
 *) Realization up to March 31, 2000
 1) Budget (April – December 2000)
 2) Budget (revised)
 3) Before FY 2000, including Income Tax on oil
 4) Before FY 2000, including Income Tax on gas
 5) Including privatization and asset recovery
 6) Errors and omissions
 Source : Ministry of Finance

Table 32
Government Expenditures
(Billions of Rupiah)

Item	1996/97p	1997/98p	1998/99p	1999/00 *	2000		2001 Budget ¹¹⁾
					Budget ¹⁾	Realization ²⁾	
Operational expenditures	47,455	72,553	118,444	168,861	156,142	182,391	190,918
Personnel expenditures	14,455	17,269	23,216	32,106	30,682	29,990	39,969
Salaries and pensions	13,004	13,698	18,657	26,427	25,761	24,868	33,658
Rice allowances	768	788	1,245	1,882	1,527	1,528	1,586
Food allowances	101	1,174	1,547	2,116	1,585	1,740	2,114
Other domestic personnel expenditures	479	671	1,073	1,040	1,014	1,047	1,371
Overseas personnel expenditures	103	938	695	640	795	806	1,240
Material expenditures	8,109	8,999	9,862	9,971	9,441	9,047	9,689
Domestic	7,825	8,242	8,888	9,791	8,676	8,339	8,735
Overseas	284	757	974	180	765	708	954
Transfer to region ³⁾	9,358	11,061	13,074	17,341	18,114	17,593	- ¹²⁾
Personnel expenditures	8,874	10,520	12,408	16,568	17,363	16,588	-
Non-personnel expenditures	484	541	666	773	751	1,005	-
Interest payment	6,610	10,818	32,864	42,846	54,623	53,329	76,550
Domestic interest ⁴⁾	-	-	8,385	22,231	37,998	37,770	53,460
Foreign interest	6,610	10,818	24,480	20,615	16,625	18,559	23,090
Subsidies	1,602	21,121	35,786	60,768	30,828	59,726	53,952
Fuel	1,416	9,814	28,607	40,923	22,462	51,135	41,304
Non-fuel ⁵⁾	186	11,307	7,179	19,845	8,366	8,590	12,648
Others, including national defence and security	7,321	3,285	3,642	5,829	12,454 ⁶⁾	12,706	10,759 ¹³⁾
Development expenditures and net lending	34,767	36,750	54,225	51,316	40,888	41,516	43,162
Ministries/institutions	11,160	11,160	12,150	11,262	7,494	7,007	16,368
Regional funds	8,869	9,864	13,575	12,661	15,409	16,301	- ¹²⁾
Subsidies to villages	458	467	474	807	670	670	-
Subsidies to regencies	2,941	3,440	3,828	4,186	6,040	6,602	-
Subsidies to provinces	1,394	1,608	1,732	2,382	3,281	3,299	-
Subsidies with land and building tax allocation	2,396	2,352	3,703	3,608	3,593	3,542	-
Construction of primary schools	592	658	591	-	-	-	-
Public health facilities	564	592	814	-	-	-	-
Subsidies for supplementary food program to primary school students	-	263	409	-	-	-	-
Subsidies to least-developed villages	524	484	218	-	-	-	-
Social safety net (SSN) program ⁷⁾	-	-	1,807	-	-	-	-
SSN and social empowerment ⁸⁾	-	-	-	1,679	-	-	-
SSN and poverty reduction ⁹⁾	-	-	-	-	2,825	2,188	-
Other expenditures ¹⁰⁾	2,838	1,340	2,318	4,161	1,956	1,608	4,530
Development budget reserves	-	-	-	-	-	-	-
Project aid	11,900	14,386	26,181	23,232	16,030	16,600	22,265
Total	82,222	109,303	172,669	220,177	197,030	223,907	234,080

p) Audited

*) Realization up to March 31, 2000

1) Budget (April - December 2000)

2) Budget (revised)

3) Since FY 1999/2000 become Regional Routine Expenditures

4) Interest payment related to banking restructuring program

5) Incl. subsidies for fertilizer, food, interest cost for government program credit, and others

6) Incl. provision for government bond interest related to banking restructuring program (Rp4,366.5 billion) and for reforestation fund (Rp4,744.8 billion)

7) Effective since FY 1998/1999

8) Effective since FY 1999/2000

9) Effective since FY 2000

10) Incl. PMP (government capital participation)

11) Budget

12) Since FY 2001 become a part of decentralisation funds

13) Incl. contingency funds for desentralisation amounted to Rp6,092,3 billion

Source : Ministry of Finance (processed)

Table 33
Funds Mobilization by Commercial Banks ¹⁾
(Billions of Rupiah)

End of period	Demand deposits			Time deposits			Saving deposits	T o t a l
	Rupiah	Foreign currency	Sub-total	Rupiah ²⁾	Foreign currency	Sub-total		
1996	44,817	12,675	57,492	119,165	43,496	162,661	61,565	281,718
1996/97	42,628	14,375	57,003	119,283	44,374	163,657	66,321	286,981
1997	53,103	30,125	83,228	125,743	80,652	206,395	67,990	357,613
1997/98	64,074	44,629	108,703	177,954	94,106	272,060	72,173	452,936
1998	58,067	39,351	97,418	303,016	103,782	406,798	69,308	573,524
1999								
March	60,002	47,244	107,246	303,022	109,778	412,800	79,453	599,499
June	63,056	38,835	101,891	325,746	91,950	417,696	89,088	608,675
September	71,250	52,357	123,607	301,469	104,389	405,858	117,802	647,267
December	68,456	47,110	115,566	301,431	85,640	387,071	122,981	625,618
2000								
January	72,629	46,213	118,842	301,020	88,050	389,070	129,857	637,769
February	73,573	45,781	119,354	304,216	86,802	391,018	132,705	643,074
March	75,847	46,078	121,925	301,087	86,670	387,757	135,801	645,483
April	75,277	48,796	124,073	302,905	87,210	390,115	138,434	652,622
May	76,604	54,777	131,381	301,908	91,187	393,095	143,374	667,850
June	84,262	49,805	134,067	289,385	87,737	377,122	146,662	657,851
July	87,511	54,114	141,625	283,019	88,528	371,547	149,162	662,334
August	90,820	51,428	142,248	286,510	81,223	367,733	148,066	658,047
September	94,576	56,820	151,396	286,843	83,942	370,785	148,665	670,846
October	100,953	58,996	159,949	293,163	90,004	383,167	149,618	692,735
November	102,182	69,959	172,141	296,284	93,150	389,435	152,937	714,513
December	104,538	70,970	175,508	296,884	93,658	390,542	154,329	720,379

1) Including deposits owned by the Central Government and nonresidents

2) Including certificates of deposits

Table 34
Commercial Banks' Demand Deposits in Rupiah and Foreign Currency by Group of Banks
(Billions of Rupiah)

End of period	State banks			Private national banks			Regional government banks			Foreign banks & joint banks			Total		
	Rupiah	Foreign currency	Sub-total	Rupiah	Foreign currency	Sub-total	Rupiah	Foreign currency	Sub-total	Rupiah	Foreign currency	Sub-total	Rupiah	Foreign currency	Sub-total
1996	15,536	2,836	18,372	21,620	5,601	27,221	4,375	2	4,377	3,286	4,236	7,522	44,817	12,675	57,492
1996/97	14,111	3,024	17,135	21,873	6,764	28,637	3,287	2	3,289	3,357	4,585	7,942	42,628	14,375	57,003
1997	17,492	7,125	24,617	24,301	12,693	36,994	4,014	7	4,021	7,296	10,300	17,596	53,103	30,125	83,228
1997/98	20,595	9,638	30,233	28,663	14,812	43,475	2,738	12	2,750	12,078	20,167	32,245	64,074	44,629	108,703
1998	24,751	8,476	33,227	23,151	13,447	36,598	4,895	13	4,908	5,270	17,415	22,685	58,067	39,351	97,418
1999															
March	28,271	11,624	39,895	21,921	14,255	36,176	4,374	12	4,386	5,436	21,353	26,789	60,002	47,244	107,246
June	26,620	9,506	36,126	23,785	12,804	36,589	5,471	12	5,483	7,180	16,513	23,693	63,056	38,835	101,891
September	29,295	12,616	41,911	27,438	18,402	45,840	6,262	12	6,274	8,255	21,327	29,582	71,250	52,537	123,607
December	25,407	12,483	37,890	26,866	15,792	42,658	7,055	15	7,070	9,128	18,820	27,948	68,456	47,110	115,566
2000															
January	25,713	11,898	37,611	29,539	15,066	44,605	7,297	23	7,320	10,080	19,226	29,306	72,629	46,213	118,842
February	26,112	11,823	37,935	30,230	14,690	44,920	6,882	14	6,896	10,349	19,254	29,603	73,573	45,781	119,354
March	28,859	12,539	41,398	32,432	14,695	47,127	5,412	16	5,428	9,144	18,828	27,972	75,847	46,078	121,925
April	26,375	12,625	39,000	32,443	15,040	47,483	6,895	20	6,915	9,564	21,111	30,675	75,277	48,796	124,073
May	26,178	15,544	41,722	33,205	16,303	49,508	7,083	16	7,099	10,138	22,914	33,052	76,604	54,777	131,381
June	33,858	9,696	43,554	33,056	16,768	49,824	8,123	20	8,143	9,225	23,321	32,546	84,262	49,805	134,067
July	36,469	11,904	48,373	32,986	17,713	50,699	8,707	21	8,728	9,349	24,476	33,825	87,511	54,114	141,625
August	39,521	11,900	51,421	32,696	16,539	49,235	9,691	18	9,709	8,912	22,971	31,883	90,820	51,428	142,248
September	40,390	14,888	55,278	33,638	17,963	51,601	10,277	23	10,300	10,270	23,946	34,216	94,576	56,820	151,396
October	43,226	15,545	58,771	35,408	18,284	53,692	11,050	22	11,072	11,269	25,144	36,413	100,953	58,996	159,949
November	42,838	26,121	68,959	36,062	18,430	54,492	11,211	24	11,235	12,071	25,384	37,455	102,182	69,959	172,141
December	49,205	24,284	73,489	34,123	18,973	53,096	10,806	17	10,824	10,404	27,695	38,099	104,538	70,970	175,508

Table 35
Commercial Banks' Time Deposits in Rupiah and Foreign Currency by Maturity
(Billions of Rupiah)

End of period	24 month	12 month	6 month	3 month	1 month ¹⁾	Others	Total
1996	1,214	25,255	40,598	32,932	50,511	12,151	162,661
1996/97	1,334	27,711	42,190	33,251	47,441	11,730	163,657
1997	359	25,377	28,664	34,637	88,987	28,371	206,395
1997/98	2,140	28,937	27,841	30,101	138,596	44,445	272,060
1998	610	21,039	17,151	50,352	266,585	51,061	406,798
1998/99							
March	502	15,449	19,414	24,840	307,610	44,984	412,799
June	430	18,990	22,291	49,632	284,152	42,202	417,696
September	501	20,056	35,305	41,479	268,885	39,632	405,858
December	436	14,742	35,244	42,125	243,645	50,879	387,071
2000							
January	644	13,455	32,869	47,022	249,597	45,483	389,070
February	652	13,410	33,231	48,547	247,841	47,337	391,018
March	628	12,992	45,123	55,711	231,854	41,449	387,757
April	532	9,850	47,031	55,345	232,913	44,444	390,115
May	560	10,329	44,221	54,553	234,721	48,711	393,095
June	666	9,217	42,666	52,589	230,451	41,534	377,123
July	460	8,660	42,920	53,262	218,558	47,687	371,547
August	4,855	7,827	41,767	57,392	212,207	43,685	367,733
September	6,836	7,719	35,941	59,614	204,986	55,689	370,785
October	11,160	7,848	30,485	65,770	208,769	59,135	383,167
November	12,932	7,231	26,163	66,026	217,825	59,258	389,435
December	14,061	6,920	23,503	68,877	215,532	61,649	390,542

1) Including matured time deposits

Table 36
Commercial Banks' Time Deposits in Rupiah by Ownership
(Billions of Rupiah)

End of period	Residents										Non-residents	Total
	Government	Official entities	Insurance companies	State enterprises	Private enterprises	Social institutions	Cooperatives	Individuals	Others	Sub-total		
1996	3,990	2,134	4,933	6,131	26,792	10,684	341	46,617	17,359	118,981	184	119,165
1996/97	4,079	1,991	5,480	5,836	26,117	10,923	322	47,668	16,581	118,997	286	119,283
1997	5,363	1,786	6,323	6,540	26,512	12,784	282	56,856	9,031	125,477	266	125,743
1997/98	6,124	1,882	6,845	11,470	35,877	13,344	420	94,053	7,500	177,515	439	177,954
1998	8,805	3,626	8,399	18,241	46,408	20,041	768	182,561	13,555	302,404	612	303,016
1999												
March	8,150	3,320	7,963	16,755	47,583	17,970	726	188,258	11,487	302,212	810	303,022
June	9,600	4,578	8,936	18,483	52,347	21,128	832	197,883	11,223	325,010	736	325,746
September	10,344	4,208	10,975	17,524	51,329	22,709	774	172,889	10,078	300,830	639	301,469
December	11,268	4,713	11,916	20,463	46,882	20,187	952	173,786	10,167	300,334	1,097	301,431
2000												
January	11,519	5,608	9,905	21,904	46,580	20,014	715	173,063	10,756	300,064	956	301,020
February	12,702	4,986	11,646	24,790	48,669	19,798	692	169,654	10,649	303,586	630	304,216
March	12,455	3,863	10,844	22,616	48,714	22,328	619	169,245	9,600	300,284	803	301,087
April	12,567	4,577	11,409	25,230	48,582	21,996	777	166,587	10,352	302,077	828	302,905
May	12,056	3,898	12,846	25,769	49,049	19,844	815	166,334	10,462	301,073	835	301,908
June	7,595	4,023	12,012	23,603	48,048	19,434	604	162,654	10,599	288,572	813	289,385
July	4,816	3,482	12,966	22,661	45,995	18,847	575	161,637	11,277	282,256	763	283,019
August	4,311	4,544	13,975	22,232	47,466	18,929	606	162,648	10,393	285,104	1,406	286,510
September	4,206	4,846	24,420	19,843	41,948	21,207	1,041	162,539	4,579	284,628	2,215	286,843
October	4,602	6,832	25,549	19,323	41,950	21,291	1,711	163,952	6,583	291,792	1,371	293,163
November	4,112	6,536	25,221	18,462	42,453	22,255	1,143	167,666	6,523	294,372	1,912	296,284
December	4,408	5,162	24,412	18,595	39,653	22,864	941	172,917	6,273	295,225	1,659	296,884

Table 37
Certificates of Deposits
(Billions of Rupiah)

End of period	State banks	Non-State banks	Total
1996	4,320	11,061	15,381
1996/97	3,205	11,113	14,318
1997	777	5,894	6,671
1997/98	493	3,409	3,902
1998	1,792	5,004	6,796
1999			
March	829	2,825	3,654
June	1,054	2,696	3,750
September	801	1,751	2,552
December	491	2,156	2,647
2000			
January	460	1,977	2,437
February	288	2,352	2,640
March	279	2,715	2,994
April	270	2,954	3,224
May	261	2,931	3,192
June	245	3,017	3,262
July	259	2,912	3,171
August	306	3,352	3,658
September	360	3,434	3,794
October	405	3,158	3,563
November	456	3,218	3,674
December	410	3,215	3,625

Table 38
Commercial Banks' Saving Deposits by Type of Deposits

End of period	Saving deposits withdrawable anytime		Saving deposits		Other saving deposits		Total	
	Depositors (thousands)	Outstanding (billions of Rp)	Depositors (thousands)	Outstanding (billions of Rp)	Depositors (thousands)	Outstanding (billions of Rp)	Depositors (thousands)	Outstanding (billions of Rp)
	1996	38,044	55,858	216	131	15,324	5,577	53,584
1996/97	38,767	60,521	238	140	15,522	5,661	54,527	66,322
1997	42,872	62,765	274	173	17,295	5,052	60,441	67,990
1997/98	43,232	66,653	271	220	19,102	5,300	62,605	72,173
1998	46,292	62,506	307	1,908	18,890	4,894	65,489	69,308
1999								
March	45,442	72,328	222	2,047	18,549	5,078	64,213	79,453
June	46,853	82,306	139	1,378	18,231	5,404	65,223	89,088
September	107,916	110,184	141	972	18,242	6,646	126,299	117,802
December	66,926	115,945	161	855	17,437	6,181	84,524	122,981
2000								
January	49,602	122,521	161	850	17,593	6,486	67,356	129,857
February	64,047	125,370	166	824	17,451	6,511	81,664	132,705
March	47,607	127,821	196	1532	17,755	6,448	65,558	135,801
April	48,700	130,969	195	756	17,173	6,709	66,068	138,434
May	48,906	135,857	185	716	17,270	6,801	66,361	143,374
June	49,442	138,732	191	1065	16,825	6,865	66,458	146,662
July	49,233	141,221	198	869	16,957	7,072	66,388	149,162
August	51,020	140,638	198	702	16,195	6,726	67,413	148,066
September	80,913	146,300	302	1290	748	1,075	81,963	148,665
October	64,791	147,746	230	929	975	944	65,996	149,619
November	65,392	151,111	429	741	1,315	1,086	67,136	152,938
December	65,041	152,388	355	755	1,298	1,185	66,694	154,328

Table 39
Interest Rates on Rupiah Credits by Group of Banks ¹⁾
(Percent)

End of Period	State Banks		Regional Government Banks		Private National Banks		Foreign Banks & Joint Banks		Commercial Banks	
	Working Capital	Investment	Working Capital	Investment	Working Capital	Investment	Working Capital	Investment	Working Capital	Investment
1996	16.88	15.02	20.48	15.26	20.24	19.69	17.07	19.59	19.04	16.36
1997	20.41	16.12	23.04	15.49	28.22	27.31	26.76	25.22	25.40	18.94
1998	29.03	22.35	30.20	15.83	38.70	40.32	42.89	35.53	34.75	26.23
1999										
March	28.28	22.49	26.57	15.54	36.47	39.96	40.84	40.25	33.12	26.10
June	27.03	21.45	24.35	14.89	32.42	32.06	29.41	33.49	28.84	22.75
September	23.51	19.21	21.47	14.38	23.22	24.24	19.82	26.28	23.07	19.73
December	21.61	17.48	21.81	13.43	19.57	20.61	18.28	22.70	20.68	17.80
2000										
January	21.14	17.31	21.42	11.75	18.94	20.27	17.24	18.43	20.08	17.43
February	21.12	17.26	20.97	11.65	18.11	18.76	16.84	17.32	19.75	17.14
March	20.36	16.48	20.23	11.64	17.62	18.28	16.37	16.81	18.93	16.46
April	20.23	16.34	20.22	11.62	17.60	17.99	16.19	15.96	18.83	16.30
May	19.64	16.22	19.54	19.31	17.55	17.78	15.79	15.96	18.42	16.54
June	18.99	15.79	19.42	18.98	17.65	17.85	15.96	15.20	18.14	16.21
July	19.69	15.40	19.47	18.91	17.63	17.59	16.29	15.20	18.01	15.86
August	18.54	15.34	19.62	17.72	17.56	17.54	16.25	15.20	17.93	15.79
September	18.62	16.19	21.58	18.00	17.88	18.00	15.32	14.88	17.99	16.62
October	18.67	16.47	21.31	18.04	17.70	17.70	15.32	15.02	17.90	16.78
November	18.66	16.67	21.35	18.05	17.60	17.64	15.41	15.31	17.84	16.94
December	18.40	16.53	21.11	18.11	17.55	17.59	15.42	15.49	17.65	16.86

1) Weighted average

Table 40
Commercial Banks' Credits in Rupiah and Foreign Currency by Economic Sector ¹⁾
(Billions of Rupiah)

Description	1996	1997	1998	1999	2000			
					Mar.	Jun.	Sep.	Dec.
Credits in rupiah	234,490	261,534	313,118	140,527	130,875	134,654	139,763	152,482
Agriculture	15,158	20,340	29,430	21,139	21,959	20,066	16,134	15,028
Mining	716	2,769	2,729	879	912	1,050	2,788	2,879
Manufacturing	51,984	56,123	85,594	35,561	29,723	29,715	29,411	35,697
Trade	55,763	57,471	59,830	29,687	26,222	29,160	28,610	30,601
Services	78,391	85,598	101,129	26,332	24,092	24,000	24,121	23,784
Others	32,478	39,233	34,406	26,929	27,967	30,663	38,699	44,493
Credits in foreign currency	58,431	116,600	174,308	84,606	92,360	105,481	109,231	116,518
Agriculture	2,472	5,662	9,878	2,638	2,718	3,266	4,703	4,475
Mining	977	2,547	3,180	2,818	4,058	4,466	3,502	3,801
Manufacturing	26,866	55,556	86,074	48,698	52,908	60,311	65,484	71,085
Trade	14,823	24,793	36,534	13,601	15,056	17,548	12,805	13,498
Services	13,265	27,971	37,995	16,829	17,458	19,776	20,327	20,532
Others	28	71	647	22	162	114	2,410	3,127
Total	292,921	378,134	487,426	225,133	223,235	240,135	248,994	269,000
Agriculture	17,630	26,002	39,308	23,777	24,677	23,332	20,837	19,503
Mining	1,693	5,316	5,909	3,697	4,970	5,516	6,290	6,680
Manufacturing	78,850	111,679	171,668	84,259	82,631	90,026	94,895	106,782
Trade	70,586	82,264	96,364	43,288	41,278	46,708	41,415	44,099
Services	91,656	113,569	139,124	43,161	41,550	43,776	44,448	44,316
Others	32,506	39,304	35,053	26,951	28,129	30,777	41,109	47,620

1) Excluding inter-bank loans, loans to Central Government and non-residents, and aid counterpart funds

Table 41
Commercial Banks' Credits in Rupiah and Foreign Currency by Type of Credit and Economic Sector ¹⁾
(Billions of Rupiah)

Type/sector	1996	1997	1998	1999	2000			
					Mar.	Jun.	Sep.	Dec.
Working capital credits	222,478	277,399	345,962	167,442	165,712	180,893	18,4381	203,724
Agriculture	5,893	11,373	22,058	12,162	13,129	11,014	9,211	8,693
Mining	1,288	3,995	3,880	2,368	2,649	3,101	3,158	3,796
Manufacturing	54,602	76,585	121,867	61,278	60,445	68,913	72,577	80,572
Trade	58,695	64,336	72,065	36,181	33,861	38,943	34,131	36,318
Services	69,494	81,806	91,039	28,502	27,499	28,145	24,195	26,725
Others	32,506	39,304	35,053	26,951	28,129	30,777	41,109	47,620
Investment credits	70,443	100,735	141,464	57,691	57,523	59,242	64,613	65,276
Agriculture	11,737	14,629	17,250	11,615	11,548	12,318	11,626	10,810
Mining	405	1,321	2,029	1,329	2,321	2,415	3,132	2,884
Manufacturing	24,248	35,094	49,801	22,981	22,186	21,113	22,318	26,210
Trade	11,891	17,928	24,299	7,107	7,417	7,765	7,284	7,781
Services	22,162	31,763	48,085	14,659	14,051	15,631	20,253	17,591
Others	0	0	0	0	0	0	0	0
Total	292,921	378,134	487,426	225,133	223,235	240,135	248,994	269,000
Agriculture	17,630	26,002	39,308	23,777	24,677	23,332	20,837	19,503
Mining	1,693	5,316	5,909	3,697	4,970	5,516	6,290	6,680
Manufacturing	78,850	111,679	171,668	84,259	82,631	90,026	94,895	106,782
Trade	70,586	82,264	96,364	43,288	41,278	46,708	41,415	44,099
Services	91,656	113,569	139,124	43,161	41,550	43,776	44,448	44,316
Others	32,506	39,304	35,053	26,951	28,129	30,777	41,109	47,620

1) Excluding inter-bank loans, loans to the Central Government and non-residents, and aid counterpart funds

Table 42
Commercial Banks' Credits in Rupiah and Foreign Currency by Group of Banks and Economic Sector ¹⁾
(Billions of Rupiah)

Group/sector	1996	1997	1998	1999	2000			
					Mar.	Jun.	Sep.	Dec.
1. State banks	108,925	153,266	220,747	112,288	102,364	100,941	98,630	102,061
Agriculture	12,111	14,279	17,012	15,516	15,675	15,189	12,903	11,209
Mining	921	1,939	1,989	1,360	2,315	2,539	2,586	2,522
Manufacturing	33,562	46,868	84,510	38,489	33,075	31,101	29,839	34,878
Trade	22,887	32,970	43,601	21,958	17,870	17,912	16,056	16,431
Services	25,510	39,421	55,792	19,945	18,421	18,548	18,683	16,370
Others	13,934	17,789	17,843	15,020	15,008	15,652	18,563	20,651
2. Private national banks	149,955	168,723	193,361	56,012	60,562	68,823	73,603	82,425
Agriculture	4,912	10,185	20,272	5,740	6,300	5,305	4,906	4,987
Mining	388	2,500	2,414	371	405	426	782	863
Manufacturing	29,638	35,592	45,416	14,421	16,432	19,756	19,948	22,914
Trade	41,752	40,513	40,687	13,307	15,140	19,963	19,833	21,656
Services	58,841	63,716	72,058	15,605	15,058	15,364	15,836	17,500
Others	14,424	16,217	12,514	6,568	7,227	8,009	12,298	14,505
3. Regional government banks	6,457	7,539	6,570	6,793	7,344	8,600	9,296	10,106
Agriculture	229	267	354	853	964	954	514	527
Mining	14	21	19	18	17	14	67	65
Manufacturing	375	429	409	190	201	209	236	249
Trade	1,100	1,206	1,053	816	869	1,018	1,126	1,182
Services	2,170	2,386	1,820	1,376	1,255	1,282	1,410	1,260
Others	2,569	3,230	2,915	3,540	4,038	5,123	5,943	6,823
4. Foreign and joint banks	27,584	48,606	66,748	50,040	52,965	61,771	67,465	74,408
Agriculture	378	1,271	1,670	1,668	1,738	1,884	2,514	2,780
Mining	370	856	1,487	1,948	2,233	2,537	2,855	3,230
Manufacturing	15,275	28,790	41,333	31,159	32,923	38,960	44,872	48,741
Trade	4,847	7,575	11,023	7,207	7,399	7,815	4,400	4,830
Services	5,135	8,046	9,454	6,235	6,816	8,582	8,519	9,186
Others	1,579	2,068	1,781	1,823	1,856	1,993	4,305	5,641
5. All commercial banks (1 through 4)	292,921	378,134	487,426	225,133	223,235	240,135	248,994	269,000
Agriculture	17,630	26,002	39,308	23,777	24,677	23,332	20,837	19,503
Mining	1,693	5,316	5,909	3,697	4,970	5,516	6,290	6,680
Manufacturing	78,850	111,679	171,668	84,259	82,631	90,026	94,895	106,782
Trade	70,586	82,264	96,364	43,288	41,278	46,708	41,415	44,099
Services	91,656	113,569	139,124	43,161	41,550	43,776	44,448	44,316
Others	32,506	39,304	35,053	26,951	28,129	30,777	41,109	47,620

1) Excluding inter-bank loans, loans to the Central Government and non-residents, and aid counterpart funds

Table 43
Flow of Banknotes in Bank Indonesia Head Office and Regional Offices
(Trillions of Rupiah)

Office	1996		1997		1998		1999		2000	
	Inflow	Outflow	Inflow	Outflow	Inflow	Outflow	Inflow	Outflow	Inflow	Outflow
Jakarta	13.3	24.1	18.7	32.2	24.2	39.9	24.4	47.2	33.2	51.4
Bandung	11.8	7.0	14.1	9.1	17.9	14.7	22.2	17.1	28.0	20.4
Semarang	9.9	5.1	11.8	6.9	14.5	9.3	17.8	13.6	20.2	15.1
Surabaya	11.4	10.3	13.9	13.3	18.8	18.5	23.4	23.9	28.8	28.6
Medan	4.5	4.6	6.9	7.7	9.4	10.3	11.4	12.8	11.5	11.9
Padang	3.1	4.1	4.2	5.6	5.8	8.7	6.5	11.7	7.8	13.1
Makassar	3.7	4.1	4.7	5.4	7.3	8.8	8.7	10.0	10.4	12.4
Banjarmasin	2.9	3.9	3.6	4.9	4.8	7.2	6.1	9.0	7.8	11.2
Total	57.2	63.2	77.7	85.0	102.7	117.5	120.4	145.4	147.7	164.1

Table 44
Share of Currency Outflow by Denomination in Bank Indonesia Head Office and Regional Offices
(Percent)

Office	Rp100,000.00	Rp50,000.00	Rp20,000.00	Rp10,000.00	Rp5,000.00	<= Rp1,000.00	Total
Jakarta	34	47	12	4	2	1	100
Bandung	39	36	18	5	2	1	100
Semarang	27	45	21	5	1	0	100
Surabaya	28	54	11	5	2	1	100
Medan	30	51	12	5	2	1	100
Padang	39	34	18	6	2	1	100
Makassar	33	43	17	5	2	1	100
Banjarmasin	32	48	13	4	2	1	100

Table 45
Flow of Coins in Bank Indonesia Head Office and Regional Offices
 (Billions of Rupiah)

Office	1996		1997		1998		1999		2000	
	Inflow	Outflow	Inflow	Outflow	Inflow	Outflow	Inflow	Outflow	Inflow	Outflow
Jakarta	13.5	94.9	14.4	79.5	4.4	105.5	2.2	117.7	4.1	184.5
Bandung	14.5	8.6	17.3	8.7	10.8	12.9	11.1	14.8	15.2	21.0
Semarang	22.5	8.8	23.2	7.4	13.9	8.3	12.2	13.2	14.3	14.5
Surabaya	3.9	10.4	2.9	15.9	1.2	32.8	2.2	29.7	1.8	33.5
Medan	1.4	6.5	2.0	7.4	3.3	11.2	1.1	13.1	0.4	14.2
Padang	0.6	4.3	0.7	7.3	0.3	14.1	0.3	9.7	0.3	12.4
Makassar	1.3	4.9	1.0	7.4	0.5	12.6	0.6	11.2	1.1	10.9
Banjarmasin	1.0	4.6	0.7	6.1	0.7	15.5	0.6	11.4	1.4	11.6
Total	58.7	143.0	62.2	139.7	35.1	212.9	30.3	220.8	38.6	301.7

Table 46
World Economic Growth
(Percent)

Country	1996r	1997r	1998r	1999r	2000*
World	4.1	4.1	2.6	3.4	4.7
Industrial countries	3.2	3.4	2.4	3.2	4.2
7 major industrial countries	3.0	3.2	2.5	2.9	3.9
United States	3.6	4.4	4.4	4.2	5.2
Japan	5.0	1.6	-2.5	0.2	1.4 ¹⁾
Germany	0.8	1.4	2.1	1.6	2.9
France	1.1	2.0	3.2	2.9	3.5
Italy	1.1	1.8	1.5	1.4	3.1
United Kingdom	2.6	3.5	2.6	2.1	3.1 ¹⁾
Canada	1.5	4.4	3.3	4.5	4.7
Others	3.7	4.2	2.0	4.7	5.1
Developing countries	6.5	5.7	3.5	3.8	5.6
Africa	5.7	2.8	3.1	2.2	3.4
Middle East and Europe	4.5	5.1	3.1	0.8	4.7
Latin America	3.6	5.4	2.2	0.3	4.3
Asia	8.3	6.5	4.1	5.9	6.7
NIEs Asia	6.2	5.8	-2.3	7.8	7.9
People's Republic of China	9.6	8.8	7.8	6.6	8.0
Indonesia	7.8	4.7	-13.2	0.2	4.5
Singapore	7.5	9.0	0.3	4.5	9.9
Malaysia	8.6	7.7	-6.7	2.4	5.9
Thailand	5.5	-1.3	-9.4	4.0	4.3
Philippines	5.8	5.2	-0.5	2.2	3.9
Vietnam	9.3	8.2	3.5	3.5	-
Countries in transition²⁾	-0.5	1.6	-0.8	2.4	4.9
Central and Eastern Europe	1.7	2.1	2.0	1.3	3.1
Russia	-3.4	0.9	-4.9	3.2	7.0
Transcaucasus dan Central Asia	1.3	2.6	2.5	4.6	5.3

1) Bloomberg, January 2000

2) Excl. Belarus and Ukraine

Sources : - IMF, World Economic Outlook, October 2000

- Bank Indonesia

Table 47
World Inflation Rate
(Percent)

Country	1996r	1997r	1998r	1999r	2000 *
World	4.3	4.2	2.5	3.0	-
Industrial countries	2.4	2.1	1.5	1.4	2.3
7 major industrial countries	2.2	2.0	1.3	1.4	2.2
United States	2.9	2.3	1.6	2.2	3.2
Japan	0.1	1.7	0.6	-0.3	-0.2
Germany	1.2	1.5	0.6	0.7	1.7
France	2.1	1.3	0.7	0.6	1.5
Italy	3.9	1.7	1.7	1.7	2.5
United Kingdom	3.0	2.8	2.7	2.3	2.0
Canada	1.6	1.4	1.0	1.7	2.3
Others	3.2	2.4	2.5	1.3	2.4
Developing Countries	14.6	9.2	10.3	6.6	6.2
Africa	25.9	11.1	8.7	11.8	12.7
Middle East and Europe	24.2	23.1	23.6	20.4	17.4
Latin America	22.4	13.2	10.6	9.3	8.9
Asia	8.2	4.8	8.0	2.4	2.4
NIEs Asia	4.3	3.4	4.4	0.3	2.2
People's Republic of China	8.4	2.8	-0.8	-1.5	1.5
Indonesia	6.5	11.1	77.6	2.01	9.4
Singapore	1.4	2.0	-0.3	0.2	2.0 ¹⁾
Malaysia	3.5	2.7	5.3	3.0	1.4
Thailand	5.9	5.6	8.1	0.5	1.3
Philippina	8.4	6.0	9.7	8.5	6.6
Vietnam	5.8	3.2	7.7	7.6	-
Countries in transition	40.6	28.2	20.9	43.8	18.3
Central and Eastern Europe	32.0	36.7	17.8	20.6	18.8
Russia	47.8	14.7	27.7	85.9	18.6
Transcaucasus dan Central Asia	64.1	36.5	15.3	15.4	14.8

1) November

Source : - IMF, World Economic Outlook, October 2000

- Bank Indonesia

- BPS-Statistics Indonesia

- The Economist

Table 48
Interest Rates and Exchange Rates

Description	1996r	1997r	1998r	1999r	2000 *
Interest rates in industrial countries (%)					
Short term	4.10	4.00	4.00	3.80	–
Long term	6.10	5.40	4.50	5.30	–
Exchange rates					
Yen/USD	108.78	120.99	130.91	113.9	107.9
DM/USD	1.50	1.73	1.76	1.84	2.13
USD/GBP	1.56	1.64	1.66	1.62	1.50

Sumber : – IMF, World Economic Outlook, October 2000
– IMF, International Financial Statistics, December 2000

Table 49
World Trade of Goods Indicator
(Annual percent change)

Indicator	1996r	1997r	1998r	1999r	2000 *
Volume	5.8	10.0	4.1	5.2	10.4
Price					
Industrial goods	–3.1	–7.8	–1.2	–1.2	–5.3
Non-oil and gas primary commodities	–1.2	–3.2	–14.7	–7.1	3.2
Oil	18.4	–5.4	–32.1	37.5	47.5

Sumber : IMF, World Economic Outlook, October 2000

Table 50
Current Accounts in Industrial and Developing Countries
(Percent of GDP)

Country	1996r	1997r	1998r	1999r	2000
7 major industrial countries					
United States	-1.6	-1.7	-2.5	-3.6	-4.2
Japan	1.4	2.2	3.2	2.5	2.6
Germany	-0.3	-0.1	-0.2	-0.9	-0.2
France	1.3	2.8	2.7	2.7	3.4
Italy	3.2	2.8	1.7	0.7	1.0
United Kingdom	-0.1	0.8	-	-1.2	-1.5
Canada	0.6	-1.6	-1.8	-0.4	1.4
Developing countries					
People's Republic of China	0.9	3.8	3.4	1.3	1.2
Indonesia	-3.5	-2.3	4.3	4.0	5.5
Singapore	15.9	15.7	20.9	21.1	21.9
Malaysia	-4.9	-5.1	12.9	11.7	10.2
Thailand	-7.9	-2.0	12.8	8.8	7.2
Philippines	-4.7	-5.3	2.0	2.2	10.1

Sources : - IMF, World Economic Outlook, October 2000
- The Economist, January 2001

Appendix H

Banknote Specimen Issued in 2000

Rp 1.000 Denomination

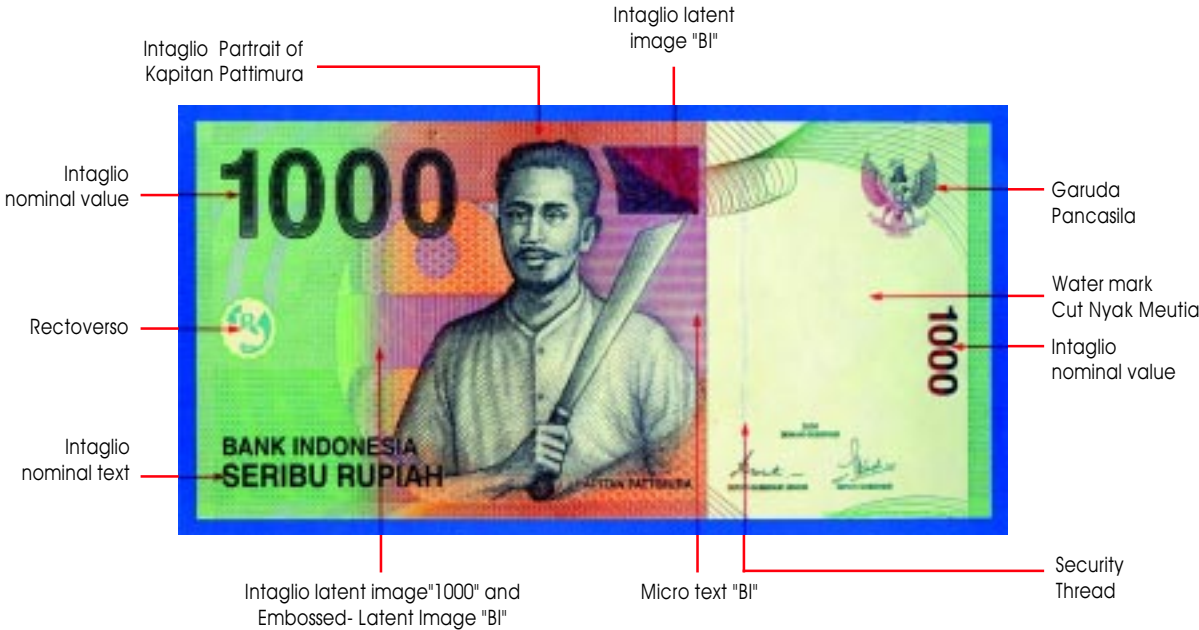

Appendix I

List of Abbreviations

ACBF	ASEAN Central Bank Forum
ADB	Asian Development Bank
ASA	ASEAN Swap Arrangement
ATM	Automated Teller Machine
APEC	Asia-Pacific Economic Cooperation
Apr	April
ASEAN	Association of South-East Asian Nations
Aug	August
Avg	Average
BBM	Fuel
BCA	Bank Central Asia
BI	Bank Indonesia
BIPS	Bulk Interbank Payment System
BIS	Bank for International Settlements
BLBI	Bank Indonesia Liquidity Support
BNI	Bank Negara Indonesia-commercial bank
BOE	Bank of England
BOG	Board of Governors
BOTASUPAL	National Coordinating Board for Counterfeiting and Forgeries Eradiction
BPM	Balance of Payment Manual
BPK	Supreme Audit Agency
BPS	Central Statistics Agency
BRI	Bank Rakyat Indonesia-commercial bank
BTO	Bank Take Over
BTN	Bank Tabungan Negara-commercial bank
C	Current
CAR	Capital Adequacy Ratios
CCL	Contingent Credit Lines
CGI	Consultative Group on Indonesia
CPI	Consumer Price Index
CPO	Crude Palm Oil
D	Doubtful
DAP	Detailed Action Plan
Dec	December
DEM	Deutsche Mark
DGS	Senior Deputy Governor of Bank Indonesia

DKI	Directorate of Financial Management-Bank Indonesia
DPNP	Directorate of Banking Research and Development-Bank Indonesia
DPM	Directorate of Monetary Management-Bank Indonesia
DSM	Directorate of Economic and Monetary Statistics-Bank Indonesia
DSR	Debt Service Ratio
DVP	Delivery Versus Payment
EFF	Extended Fund Facilities
EFT	Electronic Fund Transfer
EMEAP	Executive Meeting of East Asian and Pacific Central Banks
EO	Exchange Offer
EVO	Independent Evaluation Office
FCDs	Foreign Currency Deposits
FDI	Foreign Direct Investment
F	File
FLI	Intraday Liquidity Facility
FR	Fixed Rate Bond
FPJP	Short-term Funding Facility
GDP	Gross Domestic Product
GFCF	Gross Fixed Capital Formation
GFA	Gross Foreign Assets
GTZ	Gesellschaft für Technische Zusammenarbeit
HIPC	Heavily Indebted Poor Countries
IBRA	Indonesia Banking Restructuring Agency
IAI	Indonesia Accounts Association
ICOR	Incremental Capital Output Ratio
IDR	Indonesian Rupiah
IBRD	International Bank for Reconstruction and Development
IMF	International Monetary Funds
IPO	Initial Public Offers
IRFCL	International Reserves and Foreign Currency Liquidity
Jan	January
JBIC	Japan International Cooperation
JITF	Jakarta Initiative Task Force
JIBOR	Jakarta Interbank Offered Rate
JPY	Japanese Yen
Jun	June
Jul	July
KAPET	Integrated Development Zones

KHM	Minimum Living Requirement
KMK	Working Capital Credit
KPMM	Capital Adequacy Ratio Regulation
KRW	Korean Won
L	Loss
LNG	Liquified Natural Gas
LPG	Liquified Petroleum Gas
LoI	Letter of Intent
L/C	Letter of Credit
MDBP	Master Document of Bank Supervision
MEEP	Memorandum of Economic and Financial Committee
MMBTU	Mile Mile British Thermal Unit
MPR	People's Consultative Assembly
NBFI	Non-Bank Financial Institutions
NCG	Net Claims on the Central Government
NDA	Net Domestic Assets
NIM	Net Interest Margin
NIR	Net International Reserves
NOI	Net Other Items
NPLs	Non-Performing Loans
Nov	November
Mar	March
MUI	Indonesia Council of Ulemas
Oct	October
ODA	Official Development Assistance
OKJ	Jakarta Automated Clearing
O/N	Overnight
OPEC	Organization of Petroleum Exporting Countries
OPT	Open Market Operation
OSP	On-Site Supervisory Presence
PAN	Audited Realization
PAPSI	Accounting Guidelines for Sharia Banking in Indonesia
PBI	Bank Indonesia Regulation
PERURI	State-owned Currency Printing Company
POS	Point of Service
PET	Selected Exporting Companies
PHP	Philippines Peso
PPP	Purchasing Power Parity

PPn	Value Added Tax
PPnBm	Luxurious Goods Tax
PNM	Permodalan Nasional Madani
Propenas	National Development Program
PSAKS	Accounting Principles for Sharia Banking
PT	Limited Liabilities Company
PUAB	Interbank Money Market
REER	Real Effective Exchange Rate
Repeta	Annual Development Plan
Repo	Repurchase Agreement
RMB	Real Money Balance
Rp	Rupiah
RTGS	Real Time Gross Settlement System
SBA	Stand-By Arrangement
SBI	Bank Indonesia Certificates
SD	Selective Default
SDDS	Special Data Dissemination Standard
SDRs	Special Drawing Rights
SEACEN	South East Asian Central Bank
SEAZAN	South East Asia, New Zealand and Australian Central Bank
SEG	SEACEN Expert Group
SEK	Consumer Expectation Survey
Sep	September
SGD	Singapore Dollar
SNA	Standardized National Accounts
SMEs	Small and Medium Enterprises
SIABE	Export Oriented Agro-Industrial Information System
SIB	Baseline Economic Survey Information System
SIPU	Information System for Currency
SU-BI	Bank Indonesia Debt Note
SUP	Government Bond
THB	Thailand Baht
UKIP	Special Unit for Investigation of Banking Crimes
UIP	Uncovered Interest Rate Parity
US	United States
USA	United States of America
USAID	United States Agency for International Development
UMR	Regional Minimum Wage

VAT	Valeu Added Tax
WNB	Weighted Net Balance
WPI	Wholesale Price Index
YoY	Year on Year